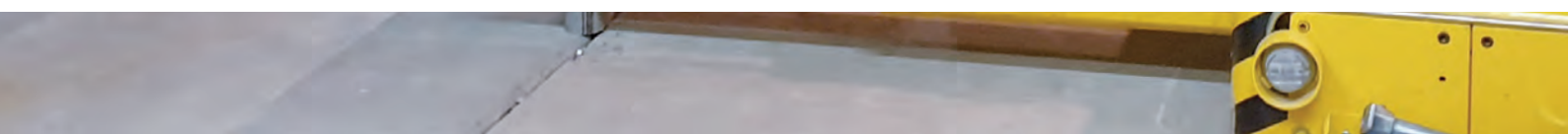




# PARTICLE PHYSICS 2019.

Highlights and Annual Report

Deutsches Elektronen-Synchrotron DESY  
A Research Centre of the Helmholtz Association



## Cover

Installation of an optical cavity at the ALPS II experiment at DESY



# PARTICLE PHYSICS 2019.

Highlights and Annual Report







An aerial photograph of a city, likely Stockholm, showing a large stadium (Sveinor Stadium) in the foreground, surrounded by dense greenery and residential areas. In the background, a highway and more urban buildings are visible.

# Contents

> Forewords and news	4
> Experimental particle physics	20
> Theoretical particle physics	52
> Projects and infrastructure	64
> References	80



# The year 2019 at DESY

## Chairman's foreword

*Dear Colleagues and  
Friends of DESY,*

2019 was a year marked by distinct ups and downs, on the strategic, operational and personnel side.

Most prominently, DESY turned 60! In December 1959, Professor Willibald Jentschke's vision to build a national accelerator in Hamburg became a reality. The event was commemorated and celebrated with a festive reception in the Hamburg city hall in the presence of Hamburg's Deputy Mayor and Senator for Science, Research and Equality Katharina Fegebank and the newly appointed State Secretary at the Federal Ministry of Education and Research (BMBWF) Wolf-Dieter Lukas. Both of them found very encouraging words for our work, giving us great hopes that both the City of Hamburg and the German federal government will continue their support for our core business: basic research.

With Wim Leemans and Christian Stegmann, we welcomed two new directors to our laboratory: Wim has taken over the accelerator division from Reinhard Brinkmann, while Christian is heading our new astroparticle physics division. We hope that, with this restructuring, we can both strengthen our activities in astroparticle physics and give more weight to synergetic topics at the boundary of particle and astroparticle physics.

Sadly, DESY had to cope with the sudden death of Wilfried Wurth, who died unexpectedly in May during a business trip to Sweden. With him, we lost one of our pioneers in free-electron laser (FEL) research and our charismatic leading scientist of the FLASH FEL facility. The reactions we received from colleagues and institutions from all over the world made it clear again what esteem Wilfried enjoyed in



Figure 1

Helmut Dosch reviews the 60-year history of DESY at the anniversary celebration.





**Figure 2**  
Current and former DESY directors together with BMBF state secretary Wolf-Dieter Lukas and the president of the Helmholtz Association, Otmar Wiestler

the worldwide scientific community. We owe a great deal to Wilfried Wurth and will never forget him.

In particle physics, the approval by the DESY Foundation Council of the construction of the Wolfgang Pauli Centre (WPC) for theoretical physics was clearly a highlight of the year. The WPC building will offer significant potential for new synergies through state-of-the-art meeting facilities, discussion spaces, an open student area and offices for faculty of partner facilities, as well as a visitor centre with an innovative concept. As a common hub for the wide range of theoretical physics research on the campus in Hamburg-Bahrenfeld, the WPC will be the leading institute for theoretical physics in Germany and one of the outstanding institutions in the field worldwide, with important benefits for our research, training, public visibility and on-site experimental programme.

The WPC is also an important building block of our vision of a Science City Bahrenfeld. In the course of the next 20 years, our campus and its surroundings will change substantially. Together with the City of Hamburg and Universität Hamburg, we are eagerly working towards this vision, which combines

science, education and training, as well as the transfer of knowledge and innovation to industry and society. We are confident that, within the framework of the Science City Bahrenfeld, DESY will be well equipped to face its next 60 years!

Finally, I would like to thank the DESY staff and all our national and international partners, who have led the way to developing a vibrant research campus in Hamburg-Bahrenfeld.

Helmut Dosch  
Chairman of the DESY Board of Directors



# Particle physics at DESY

## Introduction

Dear Colleagues and Friends of DESY,

2019 was another exciting year for particle physics at DESY.

In January, the new cluster of excellence “Quantum Universe” of Universität Hamburg and DESY started its activities, supporting existing research opportunities and opening up new ones.

The update process of the European Strategy for Particle Physics picked up speed, most evidently through the town hall meeting in Granada, Spain, in May and the publication of the briefing book that summarises the inputs to the strategy process and evaluates their benefits. DESY scientists have provided many contributions to the strategy update. We are eagerly awaiting the outcome of the process; the new strategy is to be approved by the CERN Council in May 2020.

Within the Helmholtz Association, a lot of effort was directed towards the preparations for the next seven-year programme-oriented funding period (PoF IV). In November, the Helmholtz research field Matter, to which DESY is contributing, handed in its strategic proposal for the PoF IV period. The evaluation of all the proposals in the research field Matter is scheduled for January 2020.

Finally, in its December session, the DESY Foundation Council approved the DESY part of the funding for the construction of the building for the Wolfgang Pauli Centre (WPC) for theoretical physics. These resources will be complemented by funds from Universität Hamburg and the City of Hamburg.

2019 was also a very successful year concerning the recruitment of international high-level particle physicists.



**Figure 1**  
Participants of  
the Beamline for  
Schools competition  
2019 at DESY





Figure 2  
Inauguration of the ALPS II experiment

With Çiğdem İşsever – formerly at the University of Oxford, UK – we were able to attract an internationally renowned specialist to DESY thanks to the Helmholtz recruitment initiative. Çiğdem, who also holds an ERC Advanced Grant from the European Union, has been a leading scientist at DESY and a professor at Humboldt Universität zu Berlin since August. She is working, among other things, on Higgs physics and searches for dark matter with the ATLAS experiment at the Large Hadron Collider (LHC) at CERN.

Also in 2019, Ingrid-Maria Gregor, the leader of the DESY ATLAS group, took up a position as a joint professor for detector physics with the University of Bonn. Furthermore, Katerina Lipka successfully applied for a joint professorship with the University of Wuppertal in the framework of the Helmholtz W2/W3 programme. We congratulate Çiğdem, Ingrid and Katerina!

Last but not least, in 2019, we achieved a lot for our research. While the LHC was shut down to be upgraded, data analysis efforts were running high, as were the preparations for the construction of tracker end-caps for the ATLAS and CMS experiments. The Belle II detector at the

SuperKEKB collider at KEK in Japan started to take data. And our portfolio of on-site experiments gained momentum: The first two dipoles of DESY's former HERA electron-proton collider were installed in the HERA tunnel for the ALPS II experiment, with commissioning planned for 2020. Preparations for the BabylAXO experiment advanced well, and physics operation should start in 2024. The studies towards LUXE, MADMAX and IAXO also progressed, and we are confident that we will be able to secure the additional funding required for these experiments in the near future.

I wish you an enjoyable reading of this “Highlights” brochure and a productive and successful year 2020.

Joachim Mnich  
Director in charge of Particle Physics



# News and events

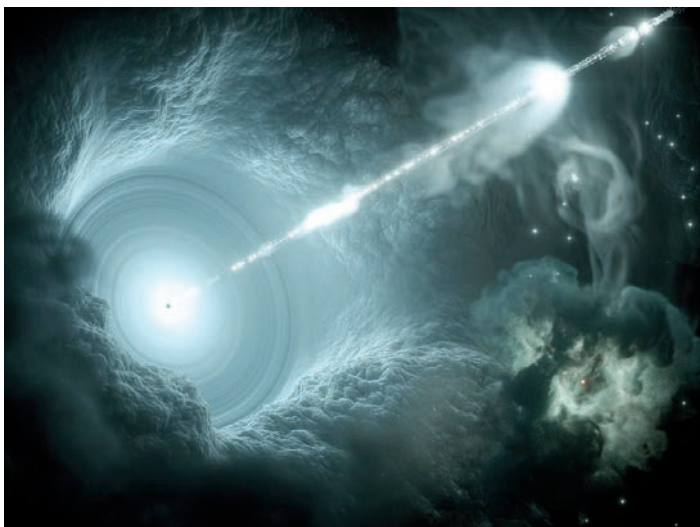
A busy year 2019

## January

### Astroparticle physics becomes new research division at DESY

To expand its activities in the exploration of the high-energy universe, DESY established a new research division for astroparticle physics at the beginning of the year. The director in charge of astroparticle physics is Christian Stegmann, who is also the head of DESY's Zeuthen site. This brings the number of research divisions at DESY up to four: accelerators, photon science, particle physics and astroparticle physics.

Astroparticle physics studies high-energy particles from outer space that originate in phenomena such as supernova explosions and active galactic nuclei. It aims to gain a fundamental understanding of the role of high-energy particles and processes involved in the evolution of the universe. It is now possible to measure all the different cosmic messengers – from cosmic rays through gamma radiation and cosmic neutrinos to gravitational waves – and to combine this information with observations made in classical astronomy. The emerging field of such combined observations of different “messengers” is called multi-messenger astronomy.



Cosmic particle accelerators such as blazars (artist's impression) are typical objects of study for multimessenger astronomy.

Within astroparticle physics, DESY is currently concentrating on studies of cosmic gamma rays and high-energy neutrinos from outer space. Both gamma-ray and neutrino astronomy are exceedingly dynamic fields of research. DESY is one of the leading institutes involved in large international observatories, such as the future Cherenkov Telescope Array (CTA), and in the upgrade of the IceCube neutrino observatory at the South Pole. Theoretical astroparticle physics is responsible for the important task of interpreting the data provided by the various cosmic messengers and describing how they are connected.



Virtual view of the Science City Bahrenfeld in 2040

### New science district to be built around DESY

The Hamburg Senate, the Altona District, DESY and Universität Hamburg presented their plans for a science district in western Hamburg – the Science City Bahrenfeld, which is to closely link science, business and housing. The new district is to be built on an area of 125 ha around the DESY campus in Hamburg-Bahrenfeld. It will include new scientific institutes and facilities, such as the Centre for Data and Computing in Natural Sciences (CDCS), the Centre for Molecular Water Science (CMWS), the Wolfgang Pauli Centre (WPC) for theoretical physics and DESY's planned 3D X-ray microscope PETRA IV, as well as around 2500 apartments.



In addition to the expansion of DESY, the plans will enable the university to move its physics, chemistry and biology departments to the science city. As a “green heart” of the new district, the Altonaer Volkspark will combine science and research with quality living, sports and health areas. First architectural competitions for the Science City Bahrenfeld are planned for 2020.

#### Acceleration record at the European XFEL

The particle accelerator of the European XFEL X-ray laser – the world’s longest superconducting linear accelerator, which is operated by DESY – lived up to expectations by accelerating the record rate of 27 000 electron bunches per second for the first time. In 2018, it had already reached its design electron energy of 17.5 GeV. The high pulse rate at the European XFEL is unique and distinguishes the facility, which opened in September 2017, from the other X-ray lasers in the world. The pilot facility for the European XFEL, the FLASH free-electron laser at DESY, already achieves 8000 pulses per second.



View into the tunnel of the 1.7-kilometre-long superconducting linear accelerator of the European XFEL

#### New network partner of “Little Scientists’ House”

DESY became a new local network partner of the “Haus der kleinen Forscher” (“Little Scientists’ House”) foundation. The largest national early-education initiative will now offer its advanced training courses for teaching staff from preschool facilities and primary schools in the fields of science, technology, engineering and mathematics, as well as on education for sustainable development, at the research centre. The aim is to provide qualified support to children of preschool and primary school age in discovering, researching and learning, and thus to promote their questioning and researching attitude. With this partnership, DESY is expanding its youth education programme to younger children. In its hands-on school lab “physik.begreifen”, DESY has long been offering experiment days for schoolchildren from fourth grade to high-school level.



Little scientists at work



## February

### Professorship for Ingrid-Maria Gregor

Ingrid-Maria Gregor, leader of the ATLAS group at DESY, took up a professorship for experimental physics at the University of Bonn in spring. The particle physicist is an expert for detector development with silicon technology and works on the construction of new subdetectors for the ATLAS experiment at CERN near Geneva. She graduated with a doctorate from the University of Wuppertal, working on the ATLAS experiment, before joining DESY. Here, she first worked at DESY in Zeuthen as a scientist on the HERMES experiment at DESY's former HERA collider, before moving to Hamburg to join the ZEUS experiment, also at HERA. Even before the Large Hadron Collider (LHC) at CERN went into operation, she switched back to the ATLAS experiment. She also coordinated the test beam activities at DESY. She has been heading the DESY ATLAS group since 2015.



Ingrid-Maria Gregor

### Federal selection contest for Physics Olympiad at DESY

For one week, 49 pupils from all over Germany participated in the federal selection contest for the International Physics Olympiad 2019 at DESY in Hamburg. The young talents had qualified for the contest among 900 applicants. Eventually, 15 pupils were nominated to participate in the German finals in Garching in April, where the five German Physics Olympians were to be identified. These five physics talents then competed against international contestants in Tel Aviv, Israel, in July.

Tasks and experiments of the 2019 federal contest at DESY were created by a team of DESY scientists, the IPN



49 pupils qualified nationally for the selection contest of the International Physics Olympiad.

competition committee and former participants. The junior physicists faced a variety of challenges: scattering off electron beams, sliding ladders, giant magnetoresistance, inflating a balloon and more. Besides the exams, the young talents were able to explore exciting physical phenomena and had many opportunities to get in touch with DESY scientists. As a reward for their performance, two candidates got the chance to deepen the knowledge gained during the week through a research internship at DESY.



The young participants of the federal selection contest for the International Physics Olympiad 2019 at DESY had to fulfil practical tasks.

### ATLAS Thesis Award for two DESY students

Nedaa Alexandra Asbah and Luise Poley, two former PhD students at DESY, were honoured for their PhD theses by the ATLAS collaboration at CERN. Nedaa Alexandra Asbah wrote her thesis on the production of Higgs particles in association with top quarks decaying into a pair of bottom quarks at the ATLAS experiment. She took up a postdoc position at Harvard University in the USA in May 2019, working on data from the LHC as well as on the upgrade of ATLAS. Luise Poley, who was a member of the ATLAS group in Zeuthen, is now Chamberlain Fellow at the Lawrence Berkeley National Laboratory in the USA. She continues her work on the upgrade of one of the innermost subdetectors of the ATLAS detector, the inner tracker, which was also the subject of her PhD thesis.



Nedaa Asbah (left) and Luise Poley with ATLAS Spokesman Karl Jakobs (left) and ATLAS Collaboration Board Chairman Max Klein



## March

### Happy birthday, World Wide Web

Everyday life without the World Wide Web? Unthinkable! First initiated by CERN scientist Tim Berners-Lee on 12 March 1989, the best-known side product of particle physics celebrated its 30th birthday on 12 March 2019.

Back in 1989, Berners-Lee had proposed a shared information system to facilitate the collaboration between his colleagues at CERN and in the rest of the world. The idea was to provide easy access to data and information, no matter where you or the data were located.

The first German website went online at DESY: While in a meeting with Tim Berners-Lee and others at CERN, DESY IT engineer Thomas Finner wrote the first HTML page and put it online under the address <http://apollo3.desy.de> in September 1992. DESY's home address was changed shortly afterwards to <http://info.desy.de>, today [www.desy.de](http://www.desy.de).

In 1993, CERN released the WWW software free of charge, thereby starting the global success story of the Web: By the end of the same year, there were already more than 500 web servers – one year later, the count was at 10 000 servers and 10 million users. The rest is history. Happy birthday, WWW!



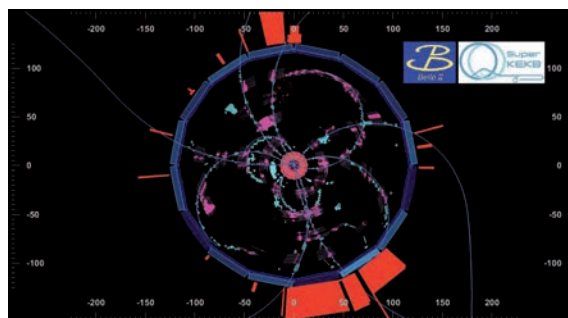
Reconstruction of the first web server. A sticker on it said: "This machine is a server. Do not power down!!"

### B factory goes into serial production

For the first time after completion of a massive upgrade of the accelerator and detector, particles collided in the Belle II detector at the particle physics centre KEK in Japan, marking the official start of the Belle II research programme. The experiment at the SuperKEKB accelerator is run by an international collaboration involving 900 scientists from 26 countries, with key participation of DESY and 11 other institutes in Germany.

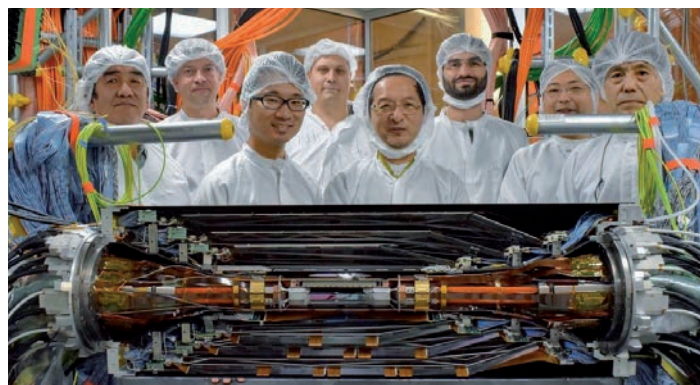
Over the next years, Belle II is set to deliver 50 times more electron–positron collisions than its predecessor Belle, hopefully enabling scientists to elucidate some of the unresolved big questions in particle physics. Why do we only see matter in the universe, although the big bang must have produced

matter and antimatter in equal amounts? What does the mysterious dark matter, which makes up a large part of the universe, consist of? The vast amounts of data will make it possible to measure physical phenomena so accurately that even tiny deviations from the theoretical foundation, the Standard Model of particle physics, will become visible. The Belle II collaboration aims to detect such deviations from the theoretically predicted behaviour in particles called *B* mesons, which consist of a bottom quark or antiquark combined with another antiquark or quark, respectively.



First collisions in the Belle II detector

Over the last nine years, the facility was completely rebuilt. Thanks to novel magnets and many technological improvements, the former KEKB electron–positron collider became SuperKEKB, which is able to generate a much smaller beam spot at increased beam intensity. This leads to a much higher data rate, which in turn makes physics analyses of very rare phenomena possible. The Belle detector also had to be upgraded, evolving into Belle II. At the very centre of the new detector, which is about 8 m in diameter and weighs 1400 t, the vertex detector precisely measures the point of origin of the particles created in the collisions. The inner part of the vertex detector is a new pixel detector developed in Germany. This highly sensitive device consists of two half-shells and is only about the size of a soda can. It was extensively tested at DESY in 2018 before being transported to Japan.



Ready for collisions: After insertion of the vertex detector, the research programme kicked off at Belle II.



## April

### Humboldt Research Award for Juan Fuster

The Spanish particle physicist Juan Fuster Verdú, professor at the Instituto de Fisica Corpuscular (IFIC) in Valencia, received a Humboldt Research Award by the Alexander von Humboldt Foundation. He will use it to intensify his collaboration with researchers at DESY, Universität Hamburg, Humboldt-Universität zu Berlin and the University of Bonn.

Juan Fuster is an international expert on precision measurements of the parameters of the Standard Model of particle physics and well known for his innovative methods both in physics analysis and in the development of new particle detectors. Over a period of five years, he will spend a total of one year in Germany, working with his German colleagues on the investigation of top-quark production at the LHC at CERN and in scenarios at future linear colliders. The top quark's mass is a fundamental parameter of the Standard Model and plays a prominent role in ultimate tests of the model, since its precise value has a significant impact on the Higgs boson potential and, ultimately, on the stability of the universe.



Juan Fuster

### “Science on tap” quenches thirst for knowledge

On 25 April, Hamburg's scientists left their labs and lecture rooms to offer entertaining insights into science at the fifth edition of “Science on Tap” (“Wissen vom Fass”). Researchers talked about their current projects in more than 50 bars and pubs, taking their audience on a fascinating tour of the world of science. Topics included the sound of the Higgs particle, the question of whether the deep sea can save our climate, or what science thinks about man flu.

The programme has been continuously extended in the past years and covers natural-science issues as well as humanities and social-science topics. Most importantly, the researchers refrain from using scientific jargon or technical aids, so their topics are easy to understand for everyone. “Science on Tap” is organised by DESY and Universität Hamburg in connection

with the clusters of excellence “Quantum Universe” and “CUI: Advanced Imaging of Matter” as well as PIER, the strategic partnership of DESY and Universität Hamburg. The event takes place every year in spring.



## June

### Superconductivity pioneer honoured

In June, DESY held a colloquium in honour of the 80th birthday of Peter Schmüser, who shaped research at DESY in many fields for more than 40 years. Schmüser started to work at DESY as a particle physicist on electron scattering experiments in the 1960s, later participating in experiments at the storage rings DORIS and PETRA. For the planning and construction of the superconducting proton ring of DESY's former electron-proton collider HERA, Schmüser switched to accelerator physics, where he contributed crucial ideas for solving several problems. Moreover, in the development of the superconducting TESLA accelerator cavities and the commissioning of the world's first free-electron laser in the soft X-ray range, now called FLASH, Schmüser set global standards regarding the increase in accelerating gradients and the development of new diagnostics technologies for ultrashort electron bunches.

Peter Schmüser's lectures were legendary, particularly those on accelerator physics, which he gave as a professor at Universität Hamburg; his textbooks have become classics. On the occasion of his 80th birthday, DESY presented him with the Silver Pin of Honour for his contributions to the research centre and for his teaching.



Pioneer of research on superconducting cavities:  
Peter Schmüser

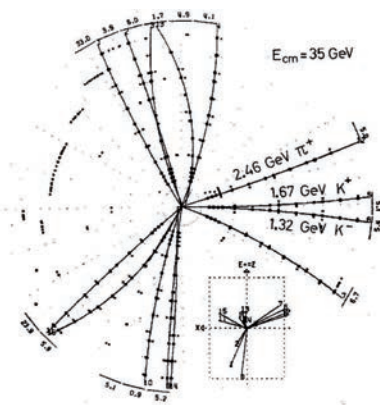


## Happy birthday, gluon

Forty years ago, in 1979, a “sticky” particle first entered the limelight: The gluon, which holds together quarks to form protons and neutrons, was discovered at DESY’s storage ring PETRA. On 18 June, at the particle physics conference “Neutrino 79” in Bergen, Norway, Bjørn Wiik – a member of the TASSO collaboration at the time who later went on to become director of DESY – presented the first image of tracks recorded by the TASSO detector showing the signature pattern of a gluon. The image consisted of three particle jets that had been produced by two quarks and the hitherto elusive gluon. Shortly afterwards, all four collaborations at PETRA observed these characteristic three-jet images in their detectors.

The discovery was preceded by the construction of the PETRA collider at a remarkable pace: It took only two years and eight months – over a year faster than originally planned – to complete the entire construction, without even having to use all the funds earmarked for the project. After the start of commissioning in autumn 1978, the beam energy was gradually increased, and in early summer 1979, the four experiments JADE, MARK J, PLUTO and TASSO took their first data at a collision energy of 27 GeV – enough to record individual gluons in the detectors.

In 1995, four scientists from the TASSO collaboration who had analysed the first images of the gluon were awarded the High Energy and Particle Physics Prize by the European Physical Society (EPS) for their discovery: Paul Söding, Bjørn Wiik, Günter Wolf and Sau Lan Wu.



Three-jet event in the TASSO detector at the PETRA collider: Two quarks produced in an electron-positron collision emit a gluon; each of the particles turns into a jet of particles. Such a picture provided the first direct evidence of the gluon.

## “Summer of Knowledge” in Hamburg

From 20 to 23 June, the first “Summer of Knowledge” took place on the Hamburg city hall square on the occasion of the 100th anniversary of Universität Hamburg. About 50 000 visitors seized the opportunity to learn more about local science in four topical tents. The tent where DESY and its partners presented research at large-scale light sources was the one with the highest visitor count.

Staff members of DESY and its research partners talked about superconductivity, particle accelerators and the scientific questions that these are able to solve. Show elements such as a superconducting train and DESY’s new VR experience served to illustrate the topics. The 2019 summer science festival replaced the usual “Night of Knowledge”, which takes place every two years with the participation of almost all the research institutions from the metropolitan region.



DESY’s superconducting train on display at the “Summer of Knowledge”

## Detector Assembly Facility officially opened

DESY’s Detector Assembly Facility (DAF) was officially opened in June. DESY and its national and international partners use the facility to build and test major and extremely complex components for the ATLAS and CMS detectors at the LHC at CERN. The DAF consists of two buildings, each equipped with ultramodern cleanrooms. One building has been in operation since 2018, the other was opened on the occasion of the meeting of the DESY Scientific Council in June 2019. In both cleanrooms, commissioning started and first prototypes were processed.

While several thousand high-precision silicon detectors are developed, built and tested in one of the cleanrooms, they will be assembled into complete detector disks – the end-caps of the silicon trackers – in the other. In a few years, these detector components will be part of the upgraded ATLAS and CMS experiments, helping scientists to search for new particles, dark matter and other unexplored phenomena.



DESY’s Detector Assembly Facility is complete.



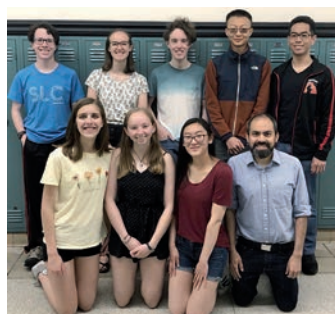
## 2019 Beamline for Schools competition

Two teams of high-school students, one from Praedinius Gymnasium in Groningen, the Netherlands, and one from West High School in Salt Lake City, USA, won the 2019 Beamline for Schools (BL4S) competition in June. In October, the teams were invited to DESY to carry out their proposed experiments together with scientists from CERN and DESY.

Beamline for Schools is a unique international competition that is open to high-school students all over the world. The students are invited to submit a proposal for an experiment that uses a beamline. Beamlines, such as those operated at CERN or DESY, deliver streams of subatomic particles to any given setup, making it possible to study a broad variety of properties and processes in various scientific disciplines. Because CERN's accelerators were shut down for maintenance and upgrade, there was no beam at CERN in 2019, which opened up opportunities to explore partnerships with other laboratories such as DESY.



2019 Beamline for Schools competition: the winning team from the Netherlands (left) and from the USA (below)



insight into everyday life in science. In addition, the nearly 50 female and about 60 male students learned the experimental and theoretical basics of accelerator, X-ray, particle and astroparticle physics in an extensive lecture programme.



91 students attended the 2019 summer student programme at DESY in Hamburg...



...while 16 studied at DESY in Zeuthen.

## July

### DESY welcomes more than 100 summer students

Over seven weeks in the summer, more than 100 students gained practical experience in research at the DESY sites in Hamburg and Zeuthen. The 2019 summer school brought together participants from more than 25 countries. The DESY summer student programme is aimed at students of physics and related natural sciences who have studied for at least three years. As one of the largest of its kind in Europe, it is not only popular because of the practical experience it offers in real research projects, but also due to its internationality.

The summer students were integrated into the practical work in the centre's research groups, thus gaining an in-depth

### Universität Hamburg is excellent

On 19 July, Universität Hamburg was awarded the title of University of Excellence. Apart from the boost in reputation, this success also brings a substantial financial boost. Over seven years, the university will receive a total of about 100 million euros. These funds will be used in 24 projects – including general education offers for students, additional professorships and measures to attract guest scientists to Hamburg.



Celebrating the nomination of Universität Hamburg as University of Excellence



## September

### Brian Foster retires

British particle physicist Brian Foster, a professor at the University of Oxford, Alexander von Humboldt professor at Universität Hamburg and leading scientist at DESY, retired in autumn. In his honour, DESY and Universität Hamburg organised a farewell symposium at DESY, at which Noble Prize winner Barry Barish held a speech named „The (ILC) Life of Brian“.

Foster came to Hamburg as a postdoc from Rutherford Appleton Laboratory in the UK to work on the TASSO experiment at DESY's PETRA collider. Since then, he has been closely connected to DESY. Foster was spokesman for the ZEUS collaboration, chairman of the European Committee for Future Accelerators, European director of the Linear Collider Collaboration and became a Humboldt professor in 2011.

The Humboldt professorship included a budget for scientific outreach. Foster used his contacts to the classical music scene to set up a very popular series of concerts at locations such as Laeiszhalle and Elbphilharmonie in Hamburg. The last concert in the series was dedicated to Foster's farewell, and another Noble Prize winner honoured him with a speech: Sir Venki Ramakrishnan, president of the UK's renowned Royal Society. Foster is a fellow of the Royal Society and has served as its vice-president for many years.



In honour of Brian Foster, a concert was given in the small hall of the Elbphilharmonie in Hamburg.

In autumn 2018, within the excellence strategy of the German federal government and states, Universität Hamburg had already won funding of several million euros for four clusters of excellence. DESY plays a major role in two of them, “Quantum Universe” and “CUI: Advanced Imaging of Matter”.

## August

### Çiğdem İşsever new leading scientist at DESY

Çiğdem İşsever, an internationally renowned particle physicist and former professor at the University of Oxford, assumed new responsibilities in Berlin at the beginning of August. She became a leading scientist at DESY in Zeuthen and a professor of experimental high-energy physics at Humboldt-Universität zu Berlin, researching the self-coupling of the Higgs boson and new elementary particles interacting with the Higgs boson.

Çiğdem İşsever, who has been conducting research at the ATLAS experiment at CERN since 2004, is working on current, central challenges in elementary particle physics. These include studying the Higgs mechanism – which gives mass to the elementary particles – with the help of Higgs pair production at the LHC and searching for clues to the nature of dark matter. İşsever holds an ERC Advanced Grant from the European Union, which supports established top researchers with up to 2.5 million euros over five years in realising new, groundbreaking approaches in their research.

The successful recruitment is the result of a joint initiative of the Helmholtz Association, Humboldt-Universität and DESY to bring top-class scientists to Germany. The Helmholtz recruitment initiative to attract top international female scientists played an important role in the move of İşsever from the UK to Germany.



Çiğdem İşsever

## October

### DESY strengthens cooperation with Armenia

On a three-day trip to the Republic of Armenia, a delegation from DESY intensified the scientific relations between DESY and research institutions in Armenia. Two joint declarations were signed, in the fields of accelerator physics, particle and astroparticle physics as well as on the general promotion of young scientists.



The DESY delegation was invited by Armenian President Armen Sarkissian.

A highlight of the trip was a meeting with Armenian President Armen Sarkissian. During his visit to DESY in Zeuthen in 2018, the president had issued an invitation to DESY Director Helmut Dosch to visit Armenia. In addition, a reception for Armenian research partners and members of the DESY delegation was held in Yerevan at the invitation of the German ambassador.

DESY has maintained close scientific relations with the A. Alikhanyan National Laboratory for decades. What began in the 1960s with the former Yerevan Physics Institute was



Visit at A. Alikhanyan National Science Laboratory (AANL) on 11 October 2019

sealed in 1993 with a first official cooperation agreement. In the meantime, the institute changed its name to A. Alikhanyan National Laboratory, and the collaborations were further intensified, especially in the fields of particle and astroparticle physics. DESY scientists are also collaborating closely with the CANDLE Synchrotron Research Institute, which is setting up its own accelerator-based radiation sources.

### PhD Thesis Prizes 2019

Max Rose (photon science) and Marcel Usner (astroparticle physics) were awarded the 2019 PhD Thesis Prize of the Association of the Friends and Supporters of DESY (VFFD). The prize was presented during the DESY Science Day in recognition of their excellent doctoral theses.

During his PhD at DESY and Universität Hamburg, Max Rose worked on improving coherent X-ray microscopy at free-electron lasers and synchrotron radiation sources. Marcel Usner started to work at DESY in 2014 and completed his PhD at Humboldt-Universität zu Berlin in 2018. His thesis dealt with the detection of cosmic tau neutrinos using the IceCube detector at the South Pole. For the first-time detection of cosmic tau neutrinos in the IceCube data, Usner significantly improved the reconstruction of events, enabling him to reliably distinguish certain double particle showers typical of tau neutrinos from showers of other types of neutrinos.



From left: PhD Thesis Prize winners Marcel Usner and Max Rose at the awarding ceremony together with VFFD Chairman Wilfried Buchmüller and DESY Director Helmut Dosch



## Helmholtz International Fellow Award for Constantia Alexandrou

Constantia Alexandrou, a professor at the University of Cyprus, received the International Fellow Award presented by the Helmholtz Association. Alexandrou, who also works at the Cyprus Institute, is considered one of the most outstanding theoretical physicists of our day; her research covers a range of topics from the structure of hadrons through uncovering the nature of dark matter to quantum computing. In addition to receiving the prize money, she was invited to spend a research visit at DESY.

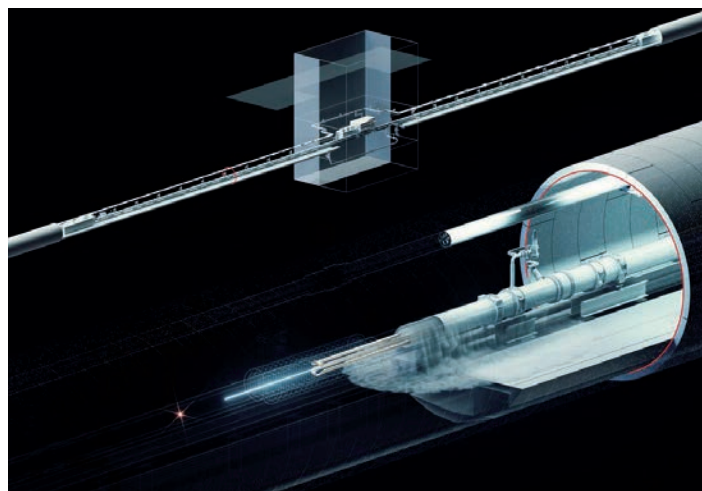
Constantia Alexandrou is the founder and director of the Computation-based Science and Technology Research Center and head of the Laboratory of High Performance Computing at the Cyprus Institute. Among other things, she used state-of-the-art supercomputers to help solve a puzzle that was one of the key focuses of research at DESY's former HERA accelerator for more than 30 years: How do quarks and gluons, the building blocks that make up protons, contribute to the proton's spin? For her analysis, widely considered to be a milestone in unravelling the proton spin puzzle, she worked closely with the particle physics group at DESY's John von Neumann Institute for Computing (NIC).



Constantia Alexandrou

## Dark-matter search enters new chapter

The international ALPS II (Any Light Particle Search) collaboration installed the first of 24 superconducting magnets in October, marking the start of the installation of a unique experiment aimed at searching for dark matter. ALPS II is set to start taking data in 2021 by looking for dark-matter particles that literally make light shine through a wall, thus providing clues to one of the biggest mysteries in physics today: What is the nature of dark matter, the invisible type of matter that is thought to make up 85% of all the matter in the universe?



Artist's impression of the ALPS II experiment

ALPS II is designed to create and detect hypothetical, very lightweight particles called axions. A strong magnetic field could make axions switch to photons and vice versa. ALPS II is being set up in a straight tunnel section of DESY's former HERA collider. Twenty-four superconducting accelerator magnets, 12 on either side of a wall, house two 120-metre-long optical cavities. A powerful laser system produces light that is amplified by one of the cavities inside the magnetic field and that could, to a very small fraction, be converted into dark-matter particles. A light-blocking barrier separates the two cavities of ALPS II, but this wall is no hurdle for axions and similar particles that can easily pass through it. In the second cavity, dark-matter particles would convert back into light. The tiny signal would be picked up by dedicated detectors.

ALPS II is also an example of recycling in research: It reuses both a stretch of tunnel that once housed DESY's flagship particle accelerator and the very magnets that drove protons around the ring until 2007. These magnets needed to be reengineered to fit the ALPS purposes.

## November

### Hamburg Prize for Theoretical Physics for Matthias Troyer

Austrian physicist and quantum computing pioneer Matthias Troyer was awarded the 2019 Hamburg Prize for Theoretical Physics for his work on simulations of strongly correlated quantum systems and the development of novel algorithms. The prize is awarded annually by the Joachim Herz Foundation together with the Wolfgang Pauli Centre (WPC) of DESY and Universität Hamburg as well as the cluster of excellence “CUI: Advanced Imaging of Matter” of Universität Hamburg.



Matthias Troyer

Troyer is a professor at ETH Zurich in Switzerland and also works in quantum research at the software giant Microsoft. He develops quantum Monte Carlo algorithms. Based on random numbers, these algorithms can be used to predict how particles in quantum-mechanical multiparticle systems – for example atoms or molecules – influence each other. Troyer is thus making significant contributions to basic research and to the further development of quantum computers and superconducting materials.

### Hertha Sponer Prize for Priscilla Pani



Priscilla Pani

DESY scientist Priscilla Pani received the Hertha Sponer Prize of the German Physical Society (DPG) for her contributions to the search for dark matter at the LHC at CERN. Pani is a particle physicist in the DESY ATLAS group and uses data

from the ATLAS detector to search for dark matter using collision events with top quarks. She led an analysis studying the signatures of dark matter in various models and coordinated a common interpretation of all ATLAS results sensitive to dark matter. She thus set new limits for the search for previously undiscovered particles that could explain dark matter.

The Hertha Sponer Prize is awarded every year to a young female scientist for outstanding research work in the field of physics. The prize is intended to encourage young women scientists through public awards and thus attract more women to physics.

### DESY particle physics behind the scenes

In November, the DESY particle physics division organised a small, internal open day. Equipped with posters and realia, the scientists explained their daily business to a crowd of interested DESY staff members, who were also eager to visit a total of nine labs and research areas where they normally do not venture.

“I am pretty sure we had more than 500 visitors,” ATLAS group leader and organisation team member Ingrid-Maria Gregor said. “We didn’t expect that many – it is great to see that so many colleagues are interested in our labs and work.” The idea to demonstrate the many facets of high-energy physics to the DESY employees, allow them a look behind the scenes and create synergies between groups turned out to be a great success.





## December

### Federal government supports expansion of DESY campus

The Budget Committee of the German Bundestag decided that DESY will receive a further 15 million euros in federal funding for the upgrading of its non-scientific infrastructure. The money is to be invested until 2022 into the renovation, modernisation and new construction of buildings that are crucial for day-to-day operations and for improving sustainability. The funds complement federal funding of more than 110 million euros already provided in previous years.

The aim of the funding is to strategically expand the DESY campus in Hamburg in the coming years and develop it into an interdisciplinary science centre. The campus development, which is to be as sustainable as possible, represents a cornerstone of the future vision of the Science City Bahrenfeld. DESY's long-term plans will enable a holistic further development of the campus and great scientific synergy effects.



Vision of the future DESY campus within the planned Science City Bahrenfeld



In contrast: Aerial view of the DESY campus in Hamburg-Bahrenfeld in 1963

### DESY turns 60

The story of DESY began on 18 December 1959 with the signing of a contract in the Hamburg city hall establishing the foundation Deutsches Elektronen-Synchrotron.



18 December 1959: Siegfried Balke (left), German Federal Minister for Nuclear Energy, and Max Brauer, Mayor of Hamburg, sign the State Treaty on the establishment of the foundation Deutsches Elektronen-Synchrotron.

In those 60 years, DESY has grown from a small Hamburg accelerator laboratory into a world leader in accelerator technology, structural research, particle physics and astroparticle physics. For 60 years, DESY has developed pioneering technologies, which scientists from all over the world have used to achieve outstanding advances. Among other things, the gluon was discovered and the ribosome structure resolved at DESY.





# Experimental particle physics

Physics with protons has been at the heart of DESY's particle physics activities since the start-up of its former electron–proton collider HERA in 1992. Today, the cornerstones of DESY's proton physics programme are its ATLAS and CMS groups, which are involved in a large variety of developments at the Large Hadron Collider (LHC) at CERN, from hardware design to data analysis. Since its discovery, the Higgs boson has come into sharp focus. Unravelling its precise properties is one of the main research activities at the LHC experiments. Studies include decays into tau leptons (p. 22), diphton and four-lepton signatures (p. 23), Higgs production associated with top quarks (p. 24), searches for additional Higgs bosons (p. 34) and the Higgs as a portal to dark matter (p. 31). Another focus of the LHC is the heaviest particle of the Standard Model, the top quark. Again, the interplay with the Higgs boson is an important topic (p. 24), as are measurements that help to understand the strong force (p. 27) and the interactions of the top quark with the electroweak gauge bosons (p. 30 and p. 39). Moreover, studies with discovery potential are continuously being performed, including searches for supersymmetry (p. 32).

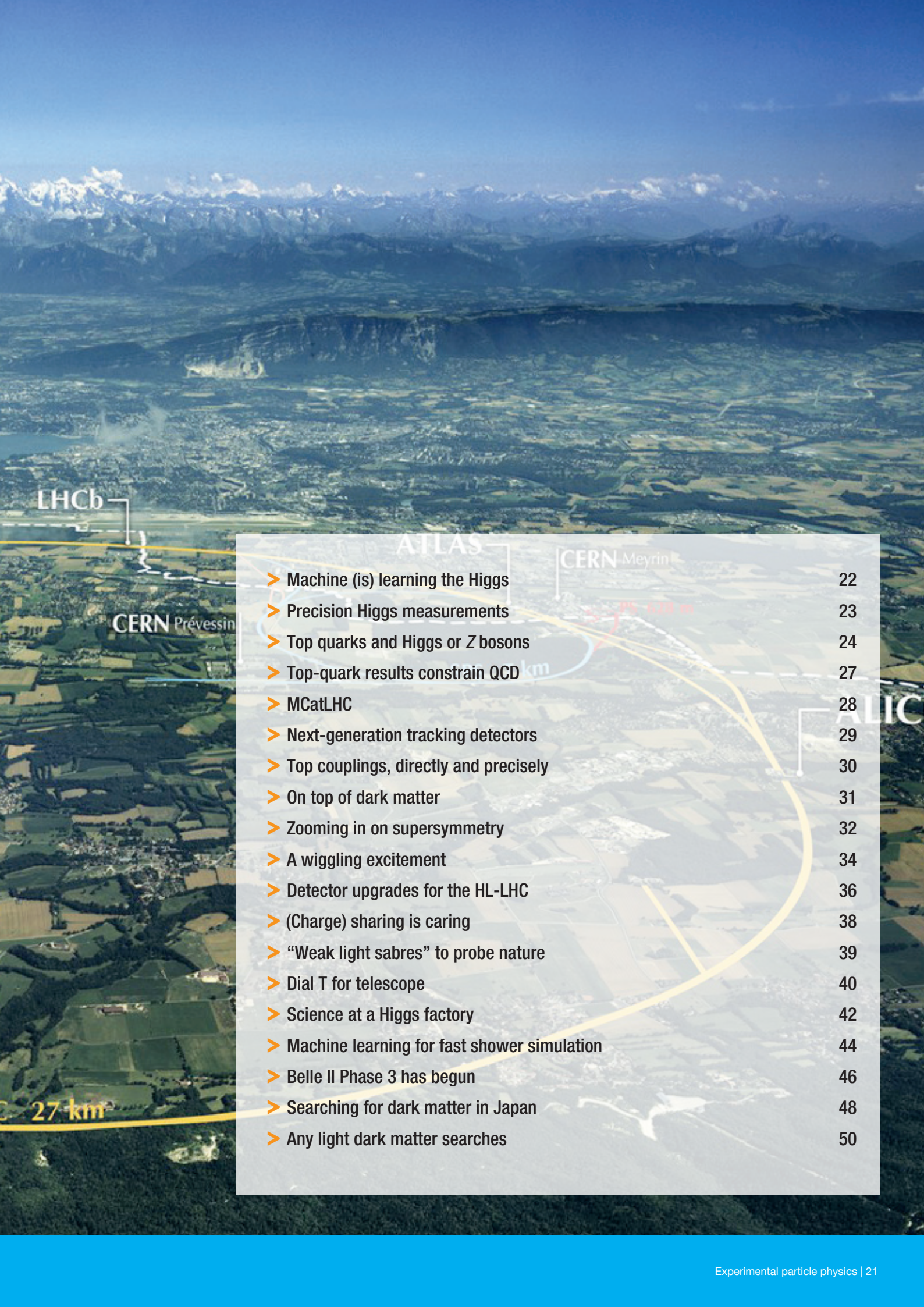
At the same time, the DESY LHC groups are preparing for the future LHC upgrades – in particular, the high-luminosity upgrade (HL-LHC) foreseen for the years after LHC Run 2. This includes the development of new detectors (p. 36 and p. 29) and sensors (p. 38), but also new tools such as Monte Carlo simulations (p. 28). Besides, new beam telescopes have been developed at the DESY II Test Beam Facility (p. 40).

Physics with lepton beams – and the R&D work for the necessary accelerators and detectors – constitutes the second pillar of DESY's particle physics activities. The focus here is on future linear colliders, particularly the International Linear Collider (ILC), and on the upgraded SuperKEKB accelerator with the Belle II experiment at the Japanese national particle physics laboratory KEK. The first Belle II data were taken in 2019 (p. 46), paving the way for new experimental discoveries in the future. The main focus at Belle II is to scrutinise the flavour sector of the Standard Model, but the experiment also has the potential to discover dark matter (p. 48). Regarding a future electron–positron linear collider, the two main activities at DESY in 2019 have been to explore the physics case of a Higgs factory (p. 42) and to improve shower simulations for this kind of accelerator experiment (p. 44).

DESY has also broadened its activities in the field of axion-like particles (p. 50). The construction of the ALPS II experiment is proceeding as foreseen, while preparations started for two new experiments, IAXO and MADMAX.

Finally, a new methodology to be used in high-energy physics research is machine learning. Applications cover all areas above and range from analysis tools to shower simulations.





> Machine (is) learning the Higgs	22
> Precision Higgs measurements	23
> Top quarks and Higgs or Z bosons	24
> Top-quark results constrain QCD	27
> MCatLHC	28
> Next-generation tracking detectors	29
> Top couplings, directly and precisely	30
> On top of dark matter	31
> Zooming in on supersymmetry	32
> A wiggling excitement	34
> Detector upgrades for the HL-LHC	36
> (Charge) sharing is caring	38
> “Weak light sabres” to probe nature	39
> Dial T for telescope	40
> Science at a Higgs factory	42
> Machine learning for fast shower simulation	44
> Belle II Phase 3 has begun	46
> Searching for dark matter in Japan	48
> Any light dark matter searches	50



# Machine (is) learning the Higgs

Scrutinising the Standard Model through Higgs physics with tau leptons

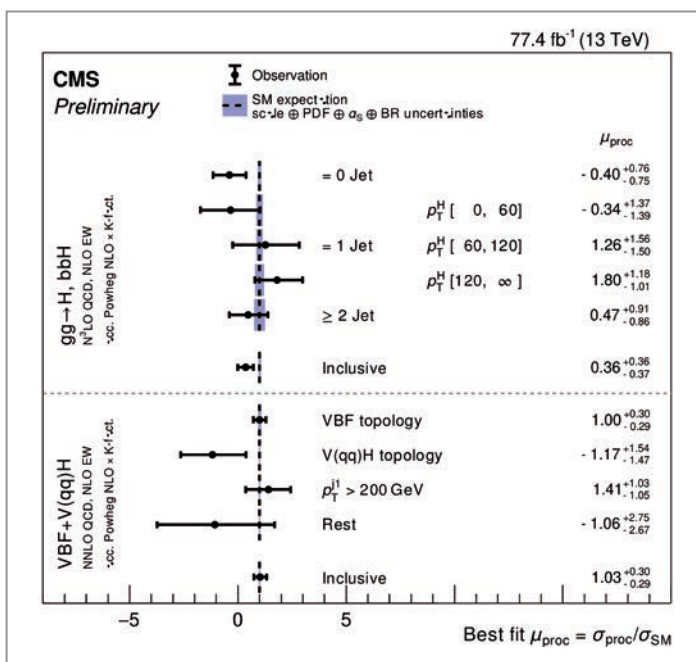
After the discovery of the Higgs boson decay to tau leptons in 2016 [1], the CMS collaboration at the LHC applied a novel analysis approach based on multi-classification machine learning techniques to measure the Higgs boson couplings to tau leptons as precisely as possible. The analysis made use of data collected by the CMS experiment at a centre-of-mass energy of 13 TeV in the years 2016 and 2017, corresponding to an integrated luminosity of  $77.4 \text{ fb}^{-1}$ . The DESY CMS group was strongly involved in this effort, performing the measurement in the decay channel of the tau lepton pair into an electron–muon pair.

Understanding the mechanism of electroweak symmetry breaking by measuring the Higgs boson couplings to fermions with high accuracy is one of the main goals of the LHC physics programme. Any deviation of the measured couplings from the predictions of the Standard Model would hint at new physics.

The analysis studying Higgs boson decays to tau leptons was performed based on a new analysis approach using a neural-network classification algorithm. The neural network separates Higgs boson production via gluon–gluon fusion

and Higgs boson production via vector boson fusion as well as the main background processes into dedicated signal and background categories with high accuracy. While the background categories are used to gain confidence in the description of the background processes, the signal events accumulate at high values of the neural-net output in the signal categories. This approach yields a high sensitivity especially for the vector boson fusion production mode. While the training of the neural network is performed on simulated events, for the extraction of the signal about 90% of all background processes are estimated from data.

Using the described approach, the inclusive Higgs boson production cross section relative to the cross section predicted by the Standard Model was measured as  $\mu = 0.75 \pm 0.18$ , consistent with the Standard Model expectation ( $\mu = 1$ ). Additionally, the cross sections split by production mode and in different kinematic regions, presented following the simplified template cross section (STXS) scheme, were determined. The employed STXS scheme [2] was defined by a collaboration of ATLAS, CMS and theorists to permit an easier combination of results across different channels and experiments and to enable theorists to confront the physics measurements with new theoretical models. Figure 1 shows the result of the cross section measurements, which are compatible with the Standard Model expectation.



**Figure 1** Results of the cross section measurement split by production mode and in different kinematic regions. The measured values are presented with respect to the Standard Model expectation.

## Contact:

Alexei Raspereza, alexei.raspereza@desy.de  
Mareike Meyer, mareike.meyer@desy.de

## References:

- [1] CMS Collaboration, Phys. Lett. B 779, 283 (2018)
- [2] LHC Higgs Cross Section Working Group, CERN-2017-002-M, <https://doi.org/10.23731/CYRM-2017-002>, arXiv:1610.07922
- [3] CMS Collaboration, CMS PAS HIG-18-032



# Precision Higgs measurements

## Measuring the Higgs boson cross sections in two ways

The full LHC Run 2 data set allows the properties of the Higgs boson to be measured with unprecedented precision. Using the data recorded by the ATLAS detector, the DESY ATLAS group played a leading role in cross section measurements in the diphoton and four-lepton Higgs decay channels as well as their combination.

### Individual measurements

The decays of the Higgs boson into two photons or four leptons were crucial for the Higgs boson discovery. They are the channels of choice for many property measurements, thanks to their clean experimental signatures and precisely reconstructable final states. Especially in the four-lepton decay, a high signal purity can be achieved; however, the signal rates are very small. The diphoton decay channel has larger event rates but a larger background, so that the sensitivity of the two channels is similar.

The properties of the Higgs boson can be probed with measurements of differential cross sections, which could be modified in the presence of physics beyond the Standard Model (SM). The cross sections are measured as a function of different kinematic observables and event properties, for example the Higgs boson transverse momentum.

The measurements are performed in a fiducial phase space that is defined to match the kinematic acceptance of the analysis and the detector as closely as possible. This makes the measurements almost model-independent. After correction for detector effects, the measurements can be compared to different theoretical predictions.

Overall, both analyses show a good agreement to the SM calculations. Limits can be set on models for physics beyond the SM, for example to test the coupling between the charm quark and the Higgs boson.

### Combination

The differential cross section measurements in the diphoton and four-lepton decay channels are limited by statistical uncertainties even when using the full Run 2 data set. In order to achieve the best precision possible, the measurements of

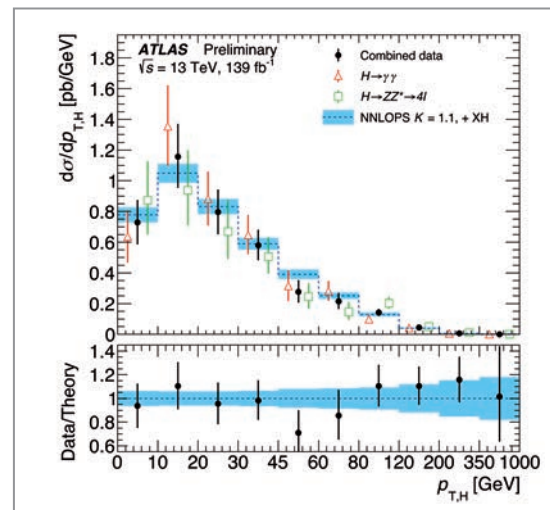


Figure 1  
Differential fiducial cross section of the transverse momentum of the Higgs boson

the Higgs boson transverse momentum in the two decay channels were combined. As the two fiducial regions of the analyses are different, the results were extrapolated to the total phase space, based on the SM expectation.

In Fig. 1, the measurement of the Higgs boson transverse momentum is shown for the combination (black dots) and the individual analyses (diphoton in red, four-lepton in green). The combination reduces the uncertainties of the measurement and is in good agreement with the SM prediction.

#### Contact:

Daniela Börner, [daniela.boerner@desy.de](mailto:daniela.boerner@desy.de)  
Sarah Heim, [sarah.heim@desy.de](mailto:sarah.heim@desy.de)

#### References:

- [1] ATLAS Collaboration, ATLAS-CONF-2019-025
- [2] ATLAS Collaboration, ATLAS-CONF-2019-029
- [3] ATLAS Collaboration, ATLAS-CONF-2019-032

# Top quarks and Higgs or Z bosons

Directly probing the couplings between the heaviest known particles

The DESY ATLAS and CMS groups are exploring new frontiers of Standard Model measurements. With the data recorded at the LHC during Run 2, in the years 2015–2018, a whole new realm has opened up, providing access to rare Standard Model processes with several heavy particles in the final state. One such class of processes are events in which top-quark pairs are produced in association with the Higgs or Z boson. With such events, the predicted couplings between the top quark and heavy neutral bosons can be probed directly for the first time, and the electroweak symmetry breaking mechanism can be further illuminated.

## Introduction

Since the discovery of the Higgs boson at the LHC in 2012, the study of its properties has been a primary goal of particle physics. In the Standard Model (SM), elementary particles are expected to acquire their mass through their interaction with the Higgs field. Deviations from expectation would indicate the presence of phenomena beyond the SM. The top quark, the heaviest known particle, is expected to couple strongly with the Higgs boson and to play a dominant role in electroweak loop corrections. So far, measurements of Higgs boson production involving top-quark loops are consistent with these predictions.

With the LHC Run 2 data, cross section measurements of top-quark-associated Higgs production ( $t\bar{t}H$ ) have become possible. Figure 1 shows an example diagram of a  $t\bar{t}H$  event. The  $t\bar{t}H$  process is special because top quarks appear in the final state. Measurements of  $t\bar{t}H$  production are thus direct probes of the coupling strength between the top quark and the Higgs boson.

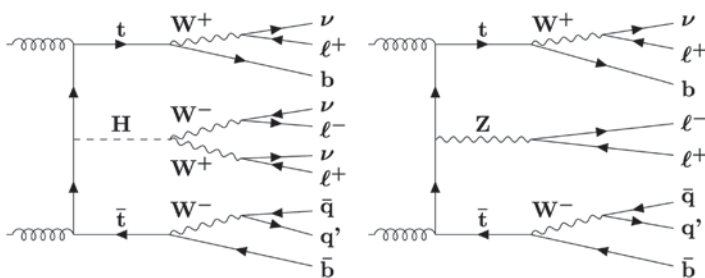


Figure 1

Example diagrams for top-quark pair-associated Higgs boson production (left) and Z boson production (right), with their decays into a final state with a total of three charged leptons ( $l$ ), four jets ( $q$  or  $b$ ) and undetected neutrinos ( $\nu$ )

Similarly, measurements of the production of Z bosons in association with top-quark pairs ( $t\bar{t}Z$ ) provide a first opportunity to directly measure the coupling of the top quark with the Z boson and to test the quark flavour universality.

Both processes,  $t\bar{t}H$  and  $t\bar{t}Z$ , have very low cross sections. The  $t\bar{t}H$  production process occurs in less than 1% of all Higgs boson events, and only about 1 out of 1000 top-quark events also contains a Z boson.

In the channel with three leptons (electrons or muons) in the final state,  $t\bar{t}Z$  and  $t\bar{t}H$  events are mutual backgrounds to

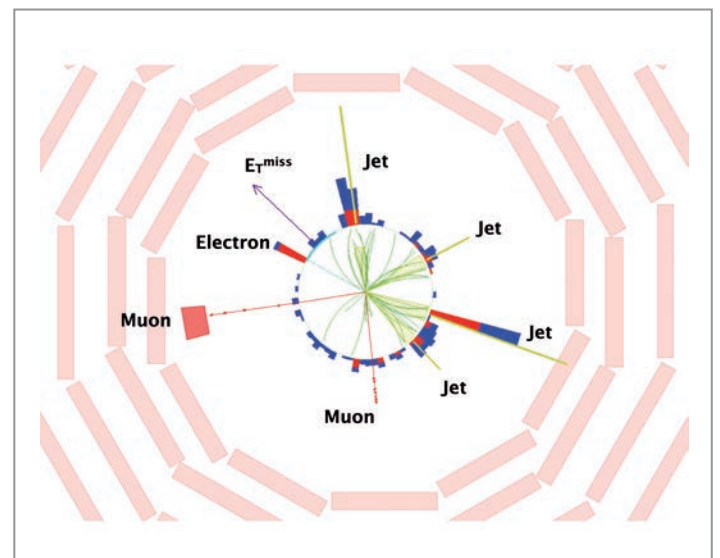
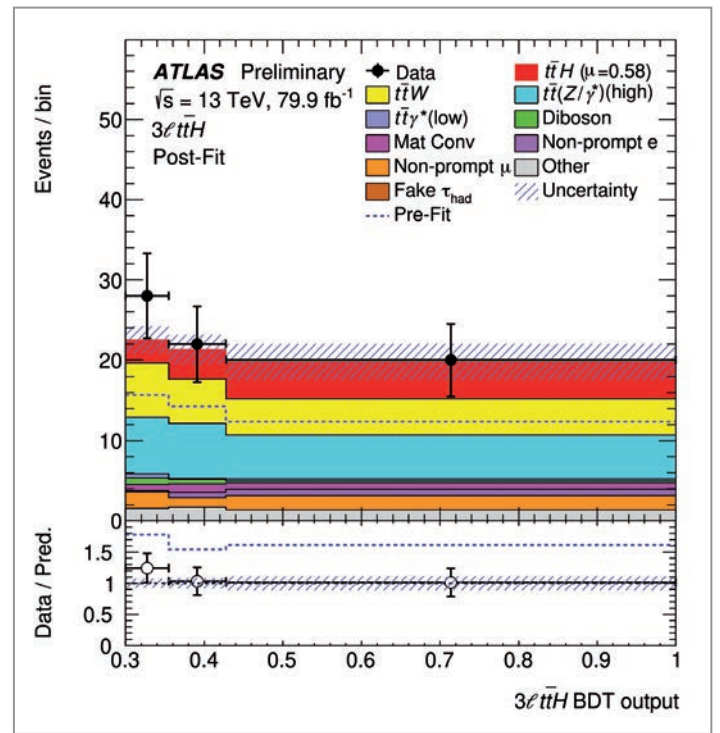


Figure 2

Schematic view of a  $t\bar{t}Z$  candidate event with four jets, three leptons (electrons or muons) and missing momentum ( $E_T^{\text{miss}}$ ) due to the undetected neutrino. In this event, the invariant mass of the muons is consistent with that of the Z boson.



**Figure 3**  
Distribution of the BDT output for events with three leptons (electrons or muons). The data are shown together with the fitted distributions from the  $t\bar{t}H$  signal (red) and the various backgrounds. The background from the  $t\bar{t}Z$  process is shown in light blue [1].



one another. The example diagrams in Fig. 1 illustrate that both processes produce the same detectable particles in the final state, namely three charged leptons and four jets. The neutrinos cannot be detected in the experiment. In the depicted case in which the Higgs boson decays into two  $W$  bosons, the presence of several neutrinos complicates the identification of the  $t\bar{t}H$  events further.

In contrast, the  $Z$  boson can be identified in a relatively simple way by reconstructing the invariant mass of the two leptons of same flavour and opposite charge. A schematic view of a  $t\bar{t}Z$  candidate event, recorded during Run 2 at the CMS experiment, is depicted in Fig. 2.

In 2019, the ATLAS experiment released the latest results from the  $t\bar{t}H$  production analysis [1], and the CMS experiment published a measurement of the  $t\bar{t}Z$  process in multilepton final states [2]. The DESY ATLAS and CMS groups made significant contributions to these results.

### Top-quark-associated Higgs boson production

The DESY ATLAS group searched for events with several muons or electrons in the final state. Such events arise when the Higgs boson decays into a pair of massive  $W$  bosons – such as in the example shown in Fig. 1 – or  $Z$  bosons, or a pair of  $\tau$  leptons, which further decay into muons or electrons (and additional neutrinos).

The main backgrounds to the  $t\bar{t}H$  signal arise not only from  $t\bar{t}Z$  production (as discussed above for the case of three leptons), but also from  $t\bar{t}W$  and diboson production, as well as from top-quark pair production with additional light leptons arising from heavy-flavour hadron decays, jets

wrongly identified as leptons, photon conversions or other backgrounds.

The  $t\bar{t}H$  analysis is performed using six different final states categorised by number and flavour of the charged lepton candidates. Some of the channels are further split into subcategories. The selection criteria are such that each event only contributes to a single channel. The separation of the  $t\bar{t}H$  signal from the background is achieved using a machine learning technique based on boosted decision trees (BDT) and advanced statistical tools. A fit is performed in background and signal regions to extract the  $t\bar{t}H$  cross section. In the fit, the normalisation of the background is determined, exploiting the shape of the discriminant output distribution.

Figure 3 shows the distribution of the BDT output discriminant for events in the three-lepton category. The distribution of the measured number of  $t\bar{t}H$  events is shown as a filled red histogram on top of the backgrounds, as determined from the fit. The background from the  $t\bar{t}Z$  process is indicated in light blue.

The best-fit results for the observed production cross sections in the six channels of the measurement are shown in Fig. 4. Here, the signal strength  $\mu$ , i.e. the measured cross section divided by the expected cross section, is shown separately for each channel. Within uncertainties, the results are consistent with the SM expectation ( $\mu = 1$ ). In combination, the measurements have a  $t\bar{t}H$  signal significance over background from other SM processes of 1.8 standard deviations where 3.1 standard deviations are expected.

The normalisation factors obtained for the  $t\bar{t}W$  background in the phase space selected by this analysis are in the range of

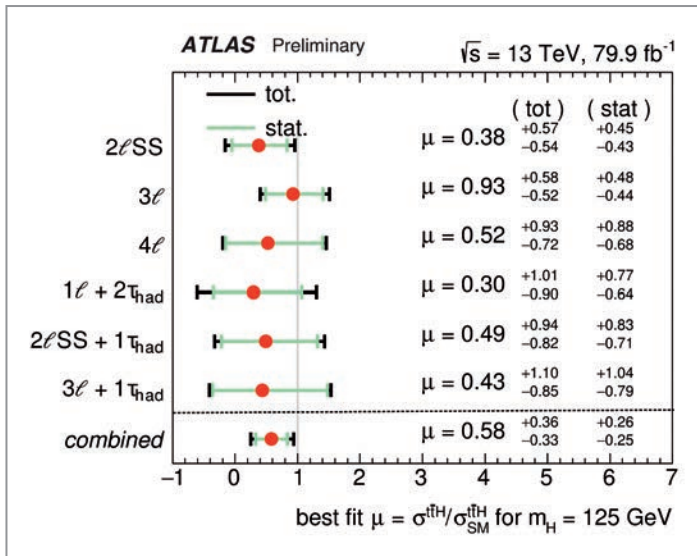


Figure 4 Observed best-fit values of the  $t\bar{t}H$  signal strength  $\mu$  and their uncertainties, separately for each analysis channel and in combination [1]

1.3–1.7 above theoretical predictions. An improved description of the  $t\bar{t}W$  background is needed to reach greater precision in the future.

### First differential measurement of $t\bar{t}Z$ production

For the measurement of  $t\bar{t}Z$  production, the DESY CMS group made use of events with three leptons in the final state. The  $Z$  boson was reconstructed in its decay into two charged muons or electrons of opposite charge. Their invariant mass is required to be consistent with that of the  $Z$  boson. A third lepton as well as additional jets arise from the top-quark decays. The analysis of  $t\bar{t}Z$  events is significantly simpler than that of  $t\bar{t}H$ , as the  $Z$  boson resonance can experimentally be reconstructed very clearly in the decay  $Z \rightarrow \ell\ell$ .

As a result, the number of events above backgrounds is large enough to perform a first differential measurement. Such measurements are of particular interest, as deviations due to anomalous couplings are mostly expected towards large transverse momenta of the  $Z$  boson. Furthermore, in differential measurements, the calculations in perturbative quantum chromodynamics (QCD) of the production process can be tested with precision.

Figure 5 presents the measured differential cross section for  $t\bar{t}Z$  production as a function of the transverse momentum of the  $Z$  boson. The data are compared with theoretical predictions calculated to next-to-leading order (NLO) in QCD. A very recent calculation including next-to-next-to-leading-log (NNLL) contributions is also shown. Within current uncertainties, good agreement is found.

## Conclusions

The LHC Run 2 data have opened a new realm of measurements of top-quark-associated Higgs and  $Z$  boson production, which provide direct probes of the top-quark couplings. The DESY ATLAS and CMS groups are exploring these processes and have produced first promising results. The current results include data recorded before the end of 2017. The analyses of the full Run 2 data are currently under way. In the future, further refined analyses and more LHC data are expected to lead to a precision that has the potential to exclude or uncover even small deviations of the SM predictions from the data.

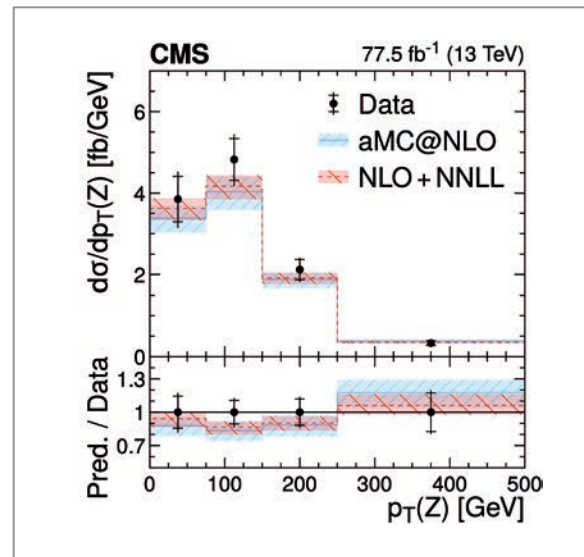


Figure 5 Measured differential  $t\bar{t}Z$  production cross section as a function of the transverse momentum  $p_T(Z)$  of the  $Z$  boson. The data are compared with predictions from the MadGraph5\_aMC@NLO generator and with a prediction to NLO+NNLL accuracy [2].

### Contact:

Kirill Grevtsov, kirill.grevtsov@desy.de  
 Judith Katzy, judith.katzy@desy.de  
 Joscha Knolle, joscha.knolle@desy.de  
 Andreas Meyer, andreas.meyer@desy.de

### References:

- [1] ATLAS Collaboration, <http://cds.cern.ch/record/2693930>
- [2] CMS Collaboration, JHEP 03, 056 (2020)



# Top-quark results constrain QCD

Most precise top-quark mass and first measurement of its running

The top quark allows for stringent tests of the theory of strong interactions, quantum chromodynamics (QCD). For the first time, DESY CMS physicists have measured the production of top-quark pairs as a function of three experimental observables, thereby probing three aspects of QCD simultaneously: the gluon distribution in the proton and two fundamental parameters of QCD, the strong coupling constant and the top-quark mass. Furthermore, a fundamental property of QCD that implies the dependence of the top-quark mass on the energy scale (the so-called “running”) was tested for the first time. Both analyses use data of the CMS experiment collected in proton–proton collisions at the LHC at a centre-of-mass energy of 13 TeV and study the top-quark pair production with events containing two oppositely charged leptons.

## Resolving correlations of QCD parameters

A precise understanding of the proton structure is of key importance for interpreting the LHC data. The proton structure is expressed through universal parton distribution functions (PDFs), which depend on the fraction  $x$  of the proton momentum carried by a parton and on the energy scale  $\mu$  of the process. The production of top quark–antiquark ( $t\bar{t}$ ) pairs at the LHC, dominated by gluon–gluon fusion, provides a direct probe of the gluon distribution  $g(x)$  in the proton at high  $x$ . However, in the predictions for  $t\bar{t}$  production,  $g(x)$  is strongly correlated with the top-quark mass  $m_t$  and the strong coupling  $\alpha_s$ . Both  $m_t$  and  $\alpha_s$  are fundamental parameters of QCD, and it is of key importance to know them with highest precision. The CMS collaboration

has measured for the first time triple-differential cross sections for  $t\bar{t}$  events produced in association with jets [1], the latter providing additional sensitivity to  $\alpha_s$ . This measurement is used to simultaneously extract  $g(x)$ ,  $\alpha_s$  and  $m_t$ , improving the precision of these three aspects of QCD through reduced correlations at high  $x$ , resulting in the most precise measurement of the pole mass of the top quark,  $m_t = 170.5 \pm 0.8$  GeV.

## Watching the top-quark mass run

In QCD,  $\alpha_s$  rapidly decreases at higher energy scales  $\mu$ , an effect referred to as the “running of the coupling”. The same is also true for the quark masses, which can be understood as couplings, for example in connection with the interaction with the Higgs field. The experimental verification of the mass running,  $m_t(\mu)$ , is an essential test of the validity of QCD. Furthermore, at energies probed by the LHC, the effects of physics beyond the Standard Model could lead to modifications of the running. For the first time, the running of the mass of the top quark was investigated [2] by CMS, by measuring the  $t\bar{t}$  cross section at different energy scales and extracting  $m_t(\mu)$ . The results (Fig. 1) are consistent with the running predicted by QCD.

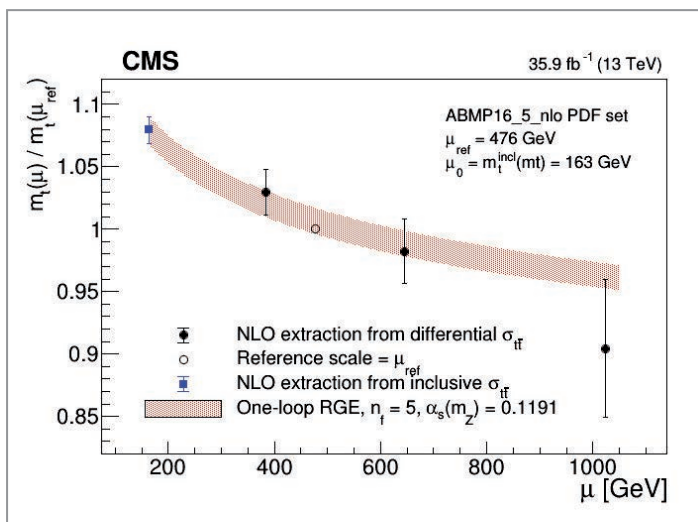


Figure 1 Running of the top quark mass [2] compared to the QCD prediction

### Contact:

Katerina Lipka, katerina.lipka@desy.de  
Olaf Behnke, olaf.behnke@desy.de

### References:

- [1] CMS Collaboration, arXiv:1904.05237
- [2] CMS Collaboration, Phys. Lett. B 803, 135263 (2020)

Physics event generators are an essential tool for LHC physics. All of the LHC scientific results, from precision measurements to searches for new physics, rely on comparisons of the experimental data with Monte Carlo (MC)-simulated events computed using generator software. DESY physicists are preparing improved simulations, which will be essential to fully exploit the ATLAS data from LHC Run 2 and beyond.

### Parton branching approach for Drell–Yan process

The transverse-momentum spectrum of  $Z_0$  bosons receives contributions from the non-perturbative intrinsic transverse momentum of partons inside the colliding hadrons. The transverse momentum from multiple soft parton radiation (described by resummation) and from hard parton radiation (described by hard perturbative matrix element calculations). The description of multiple soft parton radiation is one of the main challenges, and different approaches exist: resummation, parton shower as implemented in MC event generators, and/or the parton branching (PB) approach, which leads to transverse-momentum-dependent (TMD) parton distribution functions (PDFs).

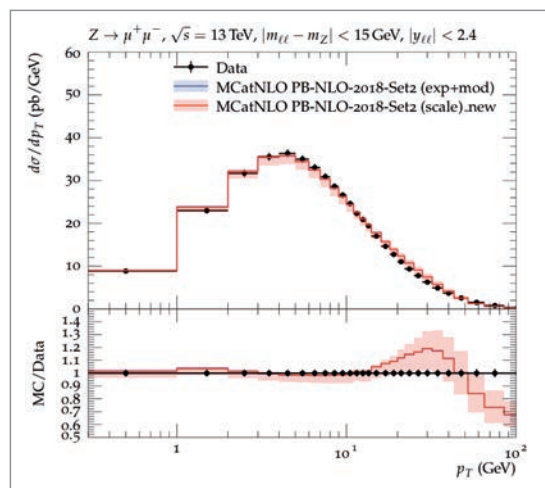
In a recent application of the PB-TMD PDFs, the transverse-momentum spectrum of  $Z_0$  bosons at a centre-of-mass energy of  $\sqrt{s} = 13$  TeV, as measured by CMS [1], could be described very well (Fig. 1). A challenge is the description of the transverse-momentum spectrum of Drell–Yan production at low masses  $m_{DY}$  and at low  $\sqrt{s}$ . Applying a previously used formalism to lower mass and lower  $\sqrt{s}$ , a very good

description of the measurements was observed. The good description is a result of the transverse-momentum spectrum included in the PB-TMD PDFs and a proper kinematic treatment of the transverse momentum in the partonic calculation.

### Event generators for precision measurements

During the LHC Run 2 phase, between 10% and 15% of the ATLAS computing resources were devoted to MC event generation, corresponding to a total of about 70 billion events produced. Yet the limited accuracy of simulated event samples remains a source of major uncertainty in many analyses.

Physicists from the DESY ATLAS group are leading the development and production of new MC event samples. The new samples have better theoretical accuracy, typically merging matrix elements at next-to-leading-order (NLO) accuracy in quantum chromodynamics (QCD) and including the approximate effect of NLO electroweak corrections. Different variations are produced to obtain an accurate estimate of the uncertainties stemming from the modelling of both the perturbative and non-perturbative part of the simulation. Efforts are also ongoing to adapt the ATLAS software framework so as to exploit modern high-performance and heterogeneous computing architectures and increase the efficiency of the CPU-intensive part of event generation.



**Figure 1** Transverse-momentum spectrum of  $Z$  bosons at  $\sqrt{s} = 13$  TeV as measured by CMS, compared to a prediction using NLO and PB-TMD PDFs (with uncertainties)

#### Contact:

Hannes Jung, hannes.jung@desy.de  
 Simone Amoroso, simone.amoroso@desy.de  
 Thorsten Kuhl, thorsten.kuhl@desy.de

#### References:

- [1] CMS Collaboration, JHEP 12, 061 (2019)
- [2] ATLAS Collaboration, ATLAS-PHYS-PUB-2019-017



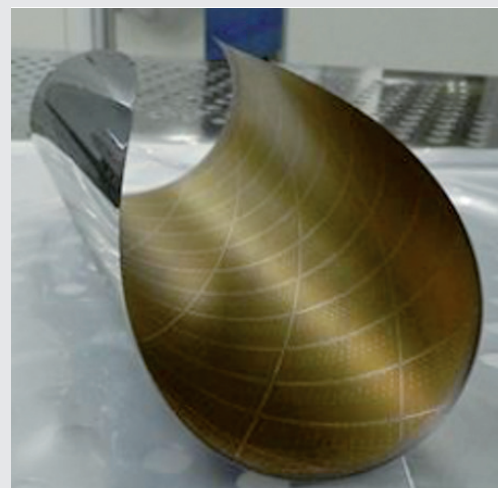
# Next-generation tracking detectors

## Overcoming the limits

DESY's long-time strong connection with the University of Bonn in Germany is now reinforced by a joint professorship between the research centre and the university. The cooperation is geared towards detector development for future tracking detectors, where very thin sensors with extremely fast timing information provide a means of disentangling particle tracks in an environment with hundreds of tracks. Additionally, very high radiation tolerance of silicon detectors might be required. To achieve this, completely new sensor and chip technologies have to be developed and optimised. DESY and the University of Bonn are experts in various areas of the field, and joining efforts will allow them to develop state-of-the-art solutions to these challenges.

The silicon tracking detectors currently under development for the High-Luminosity LHC (HL-LHC) require an unprecedented level of radiation tolerance while being lightweight and highly granular to cope with the large number of simultaneous tracks and the harsh radiation environment. Thinking further beyond to possible next-to-next particle physics experiments, much faster timing information (a few picoseconds) will offer a way to sort out tracks in an environment with extremely high numbers of tracks. At the same time, tracking detectors need to have a very low material budget while offering a precise pointing resolution ( $< 3 \mu\text{m}$ ) to provide optimal tracking performance. In addition, silicon detectors might need to be even more radiation-tolerant than what is currently being developed. To meet these challenges, completely new sensor and chip technologies have to be made available for particle physics. State-of-the-art solutions need to be investigated to develop different and novel technological approaches.

These topics are being addressed by the DESY detector development groups – since 2019 in an even closer



**Figure 1**  
Towards the dream of the perfect tracking detector [2]

cooperation with the University of Bonn, as Ingrid-Maria Gregor, leader of the DESY ATLAS group, took up a professorship for experimental physics at the university in spring. The group around the new joint professorship will exploit newly developed technologies, such as sensor material realised in CMOS technology, for a wider use in particle physics [1]. The potential of these technologies for use in tracking detector is enormous and will be exploited in the field of radiation detection. The smaller transistor size of novel CMOS technologies allows more logic to be provided within each pixel, and thus the next generation will possibly be made of “smart” detectors. Due to the complexity of such novel detectors, simulations are playing an even more important role and will be a strong part of the research.

Further synergies can be realised by developing materials where the combination of different functionalities (electrical, mechanical, thermodynamical) can yield lighter and more compact structures serving the needs of modern detectors.

The research towards highly granular, extremely lightweight tracking detectors with novel technologies is not exclusively geared towards high-energy physics applications. These technologies can be exploited in other fields, such as dosimetry, X-ray diffraction, synchrotron radiation, space science and medical applications, as well as other areas with demanding requirements, e.g. concerning radiation tolerance or material budget.

### Contact:

Ingrid-Maria Gregor, [ingrid.gregor@desy.de](mailto:ingrid.gregor@desy.de)

### References:

[1] <https://doi.org/10.1016/j.nima.2020.163784>

[2] M. Mager, Upgrade of the Alice Vertex Detector, Vertex2020



# Top couplings, directly and precisely

Probing interactions of the top quark in search for new phenomena

In many scenarios beyond the current Standard Model (SM) of particle physics, the heaviest known elementary particles – the top quark, the Higgs boson and the vector bosons  $W$  and  $Z$  – play key roles. It is therefore crucial to acquire a deep and thorough knowledge of the interactions of those particles, most notably the top quark, in the context of the SM and beyond. A Helmholtz Young Investigator Group (YIG) at DESY will exploit the huge sample of proton collisions collected by the CMS detector at the LHC to directly scrutinise the couplings of the top quark, particularly with the  $Z$  boson. The YIG will focus on a coherent set of precision measurements of rare SM processes and innovative searches for new phenomena.

The physics of the top quark, the heaviest known elementary particle, has reached the realm of high precision. However, the interactions of the top quark with other massive particles are not fully explored yet. With the huge data sample delivered by the LHC at an unprecedented centre-of-mass energy, it is now becoming possible to precisely measure the top-quark properties in events with multiple heavy particles in the final state. These processes, considered rare until quite recently, provide a unique opportunity to directly probe the interactions within the heavy sector of the SM.

In particular, the couplings between the top quark and the  $Z$  boson can be accessed in  $Z$ -associated top-quark productions. At the LHC, these events consist of a  $Z$  boson with a single top quark ( $tZq$ ) or a  $t\bar{t}$  pair ( $t\bar{t}Z$ ), where the production

of the top quark is governed by the electroweak and strong interactions, respectively. Aiming at ultimate precision in this area, the YIG at DESY is putting in place a set of coherent measurements where the  $t\bar{t}Z$  and  $tZq$  events are studied together for the first time.

Figure 1 shows the transverse-momentum ( $p_T$ ) distribution of the  $Z$  boson in  $tZq$ -like events [1]. Using a larger data set, it will become possible in the future to measure differential distributions to assess the modelling of the processes in the SM. The YIG will leverage these measurements to set stringent limits on possible effects from physics beyond the SM in the context of effective field theory (EFT). In this framework, the top-quark couplings with the  $W$  and  $Z$  boson are affected by the same operators. The YIG will exploit its prime access to the data to constrain those operators simultaneously in the production and decay of top quarks using state-of-the-art EFT models and advanced analysis techniques.

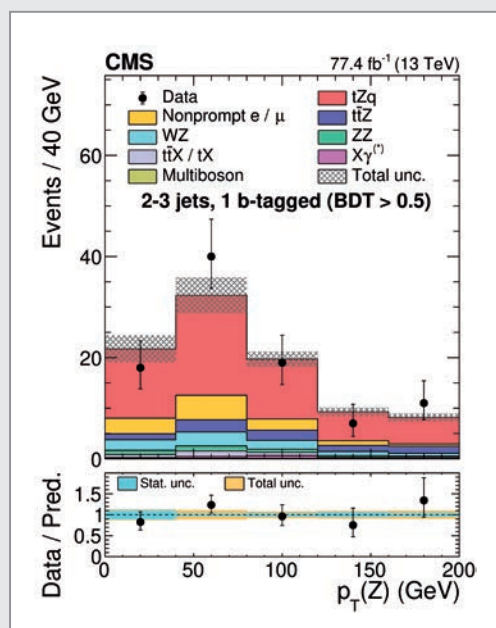


Figure 1  
Transverse-momentum ( $p_T$ ) distribution of the  $Z$  boson in  $tZq$ -like events from data collected by CMS in 2016 and 2017 [1]

## Helmholtz Young Investigator Group

“Ultimate precision measurements and search for new phenomena in processes with top quarks and a  $Z$  boson with the CMS experiment at the LHC”

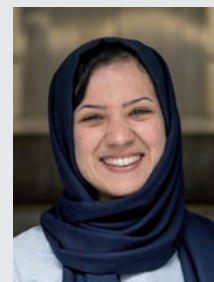


### Contact:

Abideh Jafari, [abideh.jafari@desy.de](mailto:abideh.jafari@desy.de)

### References:

- [1] CMS Collaboration, Phys. Rev. Lett. 122, 132003 (2019)
- [2] [https://hgf.desy.de/ivf/projekte/e259903/index\\_ger.html](https://hgf.desy.de/ivf/projekte/e259903/index_ger.html)





# On top of dark matter

## Scrutinising the Standard Model through Higgs physics with tau leptons

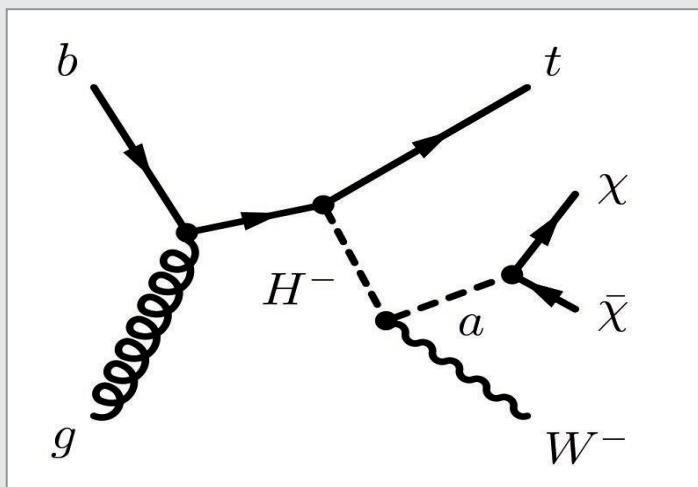
The existence of an unknown, invisible component of the matter in our universe, known as dark matter, is by now well established by cosmological measurements – yet its nature and interaction properties are still unknown. A Helmholtz Young Investigator Group (YIG) at DESY uses data from the ATLAS experiment at the LHC to investigate the particularly interesting possibility that dark-matter interactions are mediated by new scalar particles that extend the Higgs sector.

Uncovering the identity of dark matter (DM) is one of the central and grand challenges of this century for both fundamental physics and astronomy. In the high-energy proton–proton collisions at the LHC, particles that were present in the early universe can be recreated and studied in detail. The YIG focuses on the possibility that interactions between ordinary matter and DM are mediated by new scalar particles extending the Higgs sector [1].

These models were studied in the context of collider searches in a previous ATLAS publication led by members of the DESY ATLAS group and the YIG [2]. In these models, the Higgs boson partners act like a portal to a new dark sector, to which DM particles belong. Like the Higgs boson, these new mediators interact strongest with the heaviest particles and are therefore characterised by enhanced interactions to


heavy-flavour quarks (top and bottom quarks). Among all signatures that these models can produce in the collisions detected by the ATLAS experiment, the YIG has focused so far on the associated production of DM particles with a single top quark [3]. This signature, schematically depicted in Fig. 1, is resonantly enhanced in extended-Higgs DM models by the production of a heavy charged partner of the Higgs boson, making it an interesting and promising search channel.

An additional important aspect of DM models is whether they can account correctly for the DM relic density in our universe measured by space observatories that study the cosmic microwave background [4]. In general, collider constraints are weak in the parameter space of DM models where the predicted relic density is consistent with astrophysical observations. The new single-top-quark signature investigated by the YIG will allow us to extend the sensitivity towards parameter choices for the model that yield relic density values compatible with the astrophysical measurements.



**Figure 1**  
Schematic representation of a possible production mechanism of dark matter. In the associated production with a single top quark, DM is produced in the decay of a charged Higgs partner ( $H^-$ ) decaying into a  $W^-$  boson and a pseudoscalar DM mediator ( $a$ ).

**Helmholtz Young Investigator Group**  
"On top of Dark Matter"

 **HELMHOLTZ ASSOCIATION**

**Contact:**  
Priscilla Pani, priscilla.pani@desy

**References:**  
[1] M. Bauer et al., JHEP 1705, 138 (2017)  
[2] ATLAS Collaboration, JHEP 05, 142 (2019)  
[3] P. Pani et al., Phys. Dark Univ. 21, 8–15 (2018)  
[4] G. Hinshaw et al., Astrophys. J. Suppl. 208 19, 1200 (2013); Y. Akrami et al., Astron. Astrophys., arXiv: 1807.06205



# Zooming in on supersymmetry

Probing new frontiers

The search for new physics beyond the Standard Model is a key research topic of the ATLAS and CMS experiments at the LHC. Supersymmetry stands out among the plethora of new-physics models, because it provides answers to most of the fundamental open questions. Both the ATLAS and CMS group at DESY contributed to several searches for supersymmetry, tackling extremely challenging scenarios by exploiting novel analysis techniques, such as deep learning. Selected highlights of these results are presented here.

## Introduction

Supersymmetry (SUSY) is a popular extension of the Standard Model (SM), aiming to answer some of the most fundamental open questions in particle physics, such as: What is the nature of dark matter? What stabilises the Higgs boson mass at its measured value? Do the electroweak and strong forces unify at smaller distances? Supersymmetry predicts a new partner for each elementary particle, differing by half a unit of spin. The lightest supersymmetric particle (LSP) may be stable and weakly interacting, providing a viable dark-matter candidate.

The ATLAS and CMS physicists have been scrutinising the vast proton–proton collision data set delivered by the LHC, exploiting the wealth of data to focus on rarer and experimentally more challenging processes.

## Searches for third-generation squarks

The SUSY partner of the heaviest known ordinary particle, the top quark, is thought to play a crucial role in the quantum corrections to the mass of the Higgs boson, which was measured to be 125 GeV.

The hunt for the SUSY partners of the top or bottom quarks proceeded with a number of dedicated searches focusing on several scenarios. Decay chains involving other intermediate SUSY particles were studied by reconstructing the SM bosons that originate from the decays of these SUSY particles [1, 2]. Figure 1 shows the observations of a search aimed at Higgs boson decays to pairs of bottom quarks, which are predicted to occur 58% of the time, as a function of the momentum imbalance from invisible LSPs. The results of this analysis were the first at the LHC to be released within an open-access statistical likelihood format on the HEPData repository [3]. Statistical likelihoods summarise every aspect of a

particular analysis: from detector settings, event selection, expected signal and background processes to uncertainties and theoretical models. They are an important tool for theorists to test new models.

A second search, whose results are shown in Fig. 2, exploited the leptonic decays of Z bosons to pairs of charged leptons instead. Although these decays occur at a much smaller rate (about 10%), they constitute a striking signature that is easily distinguished from the SM background.

Other challenging scenarios, such as multibody decays [4] or displaced decays [5] of the SUSY partner of the top quark, were explored using novel dedicated experimental techniques,

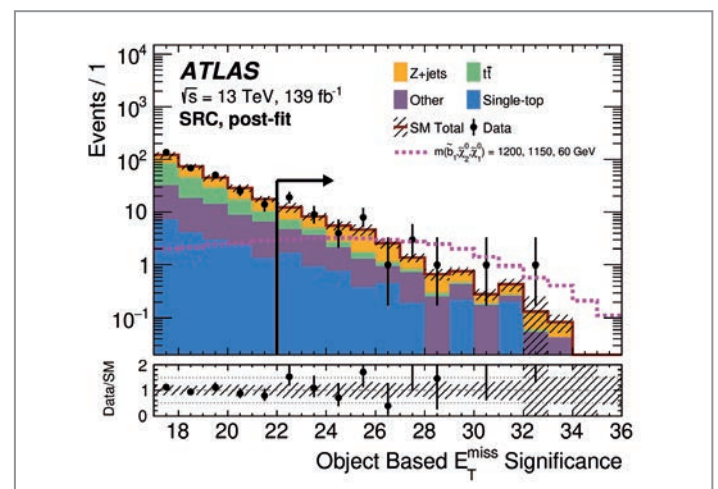


Figure 1

Distribution of the object-based significance discriminant used in the signal selections. The significance of the missing momentum is computed comparing its magnitude to the resolutions of the other measured particles. The signal (pink) is expected to extend to higher values than the SM backgrounds. From [1].



such as machine learning methods or specialised “large-radius” track and vertex reconstruction. All these searches allowed new regions of the phase space to be probed and constrained. In most of the considered scenarios, the SUSY partners were found to be constrained to masses above the TeV range.

## Searches for SUSY partners of the electroweakly interacting particles

While the production rate of the SUSY partners of quarks is higher at a proton–proton collider, it might well be that their masses are too high for them to be produced at the LHC. In that case, the SUSY partners of the electroweakly interacting particles (leptons, gauge bosons and the Higgs boson) could still be abundantly produced at the LHC.

The production of the SUSY partners of the SM bosons was explored with two complementary searches. The first search looked for the hadronic decays of the Higgs boson in the decay of SUSY particles, along with one charged lepton and momentum imbalance [6]. The second search aimed at signatures with two electrons or muons and large momentum imbalance due to the escaping LSPs [7]. Both these analyses exploited the shape of the distributions of several kinematic properties of the events to improve the SM background rejection. The results pushed the minimum mass for various SUSY particles to several hundred GeV. For example, the masses of the SUSY partners of electron and muon were constrained to lie above 700 GeV.

Some models predict the SUSY partner of the tau lepton to be the lightest of the three lepton flavours. Such a scenario is of special interest because, if the SUSY partner of the tau lepton and the LSP are close in mass, they could co-annihilate, leading to the correct dark-matter relic density.

The main production mechanism targeted in this case is the pair production of two SUSY partners of the tau lepton, which will each decay into a tau lepton and the LSP. The production rate is very small compared to the production of other SUSY particles with the same mass. In addition, the events are very difficult to distinguish from SM events that look similar and have several orders of magnitude higher production rates. Therefore, to gain sensitivity, events with different decays of the tau hadrons were combined, and machine learning methods were used to distinguish signal from background events. With data from 2016 and 2017, first sensitivity was gained in the low-mass region for masses below 150 GeV, as shown in Fig. 3.

## Conclusions

The DESY ATLAS and CMS groups will extend their search of new signatures and new areas of parameter space, employing new techniques to turn over every possible stone in the search for supersymmetric phenomena, until a hint of new physics is revealed.

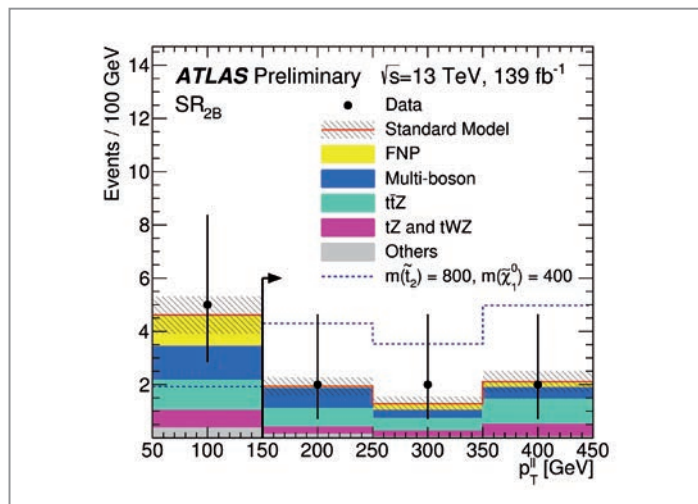


Figure 2

Distribution of the transverse momentum of the Z boson candidate in one of the signal selections. The targeted process predicts more events than the SM backgrounds.

From [2].

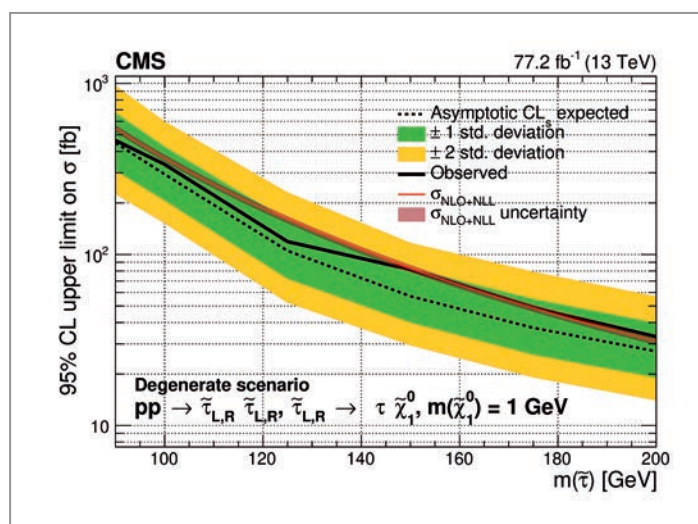


Figure 3

Upper limit on the cross section as a function of the mass of the SUSY partner of the tau lepton. The green and yellow bands indicate the respective regions containing 68% and 95% of the distribution of limits expected under the background-only hypothesis. The solid red line indicates the NLO+NLL prediction for the signal production cross section, and the dashed and solid black line designate the expected and observed upper limit. All masses for which the solid black line is below the red theory line are excluded. From [8].

### Contact:

Federico Meloni, federico.meloni@desy.de  
Isabell Melzer-Pellmann, isabell.melzer@desy.de

### References:

- [1] ATLAS Collaboration, JHEP 12 060 (2019), <https://arxiv.org/abs/1908.03122>
- [2] ATLAS Collaboration, ATLAS-CONF-2019-016
- [3] ATLAS Collaboration, ATL-PHYS-PUB-2019-044
- [4] ATLAS Collaboration, ATLAS-CONF-2019-017
- [5] ATLAS Collaboration, ATLAS-CONF-2019-006
- [6] ATLAS Collaboration, <https://arxiv.org/abs/1909.09226>
- [7] ATLAS Collaboration, <https://arxiv.org/abs/1908.08215>
- [8] CMS Collaboration, <https://arxiv.org/abs/1907.13179>

# A wiggling excitement

Hunting for heavy Higgs bosons at the CMS experiment

The discovery of a Higgs boson in 2012 at the LHC was a huge success for the LHC experiments and an important milestone in understanding the Standard Model of particle physics. At the same time, the discovery raised many questions. Is the new particle indeed the one predicted by the Standard Model? Is it the only elementary particle with vanishing spin? Does it have heavier siblings? Exploring the data recorded in 2016 at the CMS experiment, the DESY CMS group tried to answer such questions by searching for new heavy Higgs bosons decaying into pairs of top quarks.

## Beyond the Standard Model Higgs boson

The Higgs boson with a mass of about 125 GeV is the latest elementary particle discovered at the LHC. Understanding whether it is the only scalar particle or not is one of the most interesting questions in fundamental science today. Searching for new heavy Higgs bosons is particularly exciting, as they could be the missing link between the Standard Model (SM) and dark matter. Since Higgs bosons interact more strongly with particles of higher masses, decay channels involving top quarks – the heaviest particles in the SM – are dominant when the scalars are sufficiently massive. This is particularly true in models that predict suppressed couplings

of the scalars to the  $W$  and  $Z$  bosons, such as two-Higgs doublet models, within the experimentally well-supported constraint that one of the scalars is very similar to the SM Higgs boson.

## What a wiggly ride!

The CMS collaboration reported the results of the search for heavy Higgs bosons decaying into top quark pairs, using  $36 \text{ fb}^{-1}$  of data, in Ref. [1]. The DESY CMS group performed the search in the channel where both top and antitop quark decay leptonically, leading to two charged leptons, two

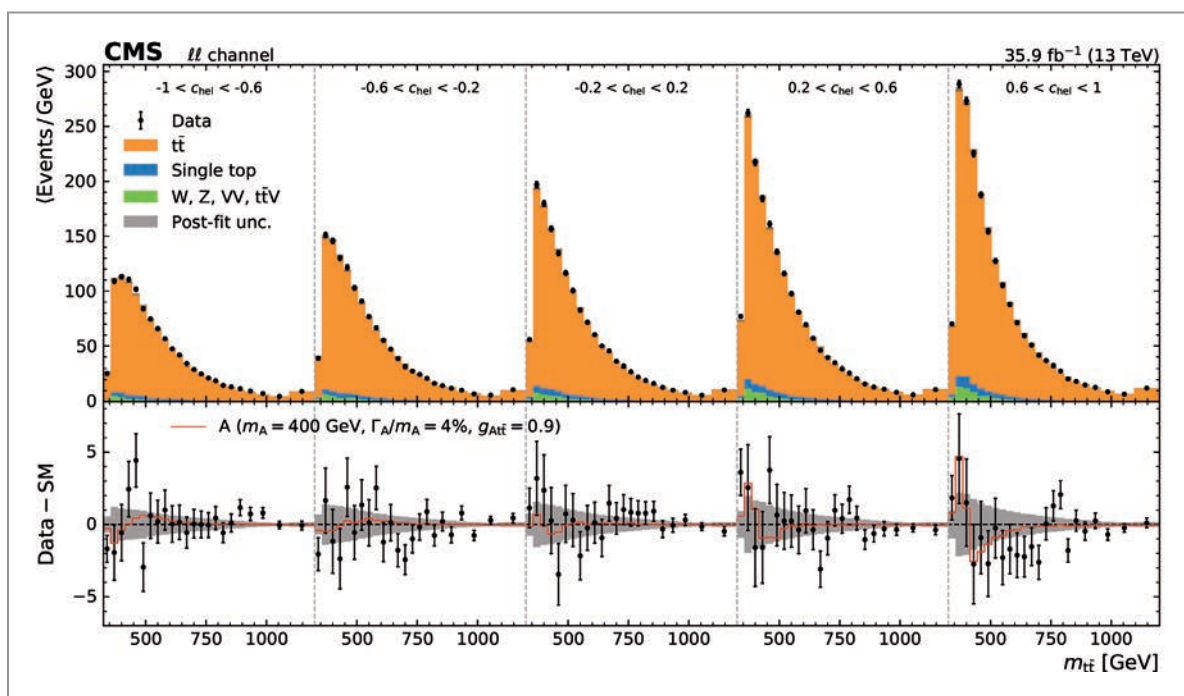


Figure 1

Invariant-mass distribution of the top-quark pair for five different intervals of the  $t\bar{t}$  spin correlation helicity angle. The results for dilepton final states are presented, comparing the number of events as predicted by the SM with the CMS data. The upper row shows the actual distribution of events, while the lower row shows the difference between data and SM prediction. The impact of the presence of a pseudoscalar Higgs boson with a mass of 400 GeV is illustrated by the red histogram.



neutrinos, and two  $b$  quarks in the final state. The search considers pseudoscalar or scalar states, denoted  $A$  and  $H$ , respectively.

The presence of such a heavy  $A$  or  $H$  boson would lead to local distortions in the invariant mass distribution of their decay products, the top-quark pairs. However, due to interference effects with SM top-quark pair production, the presence of an  $A$  or  $H$  boson signal would lead not just to a bump in the invariant  $t\bar{t}$  mass distribution, but to a peak-dip structure. In other words, we were searching for a wiggle. Such a signature is much more challenging to detect than a bump, since the experimental resolution is limited, not only due to the accuracy of the measurement in the detector, but also due to the presence of the undetected neutrinos in the final state. This leads to a smearing of the peak-dip structure in the reconstructed invariant-mass distribution, reducing the detectability of the signal.

To overcome this limitation, we investigated other properties of top-quark pair production. Because the top quark has a very short lifetime, its spin can be explored from the particles it decays to. The SM makes precise predictions for the frequency that the spin of the top quark is aligned or opposite to the spin of the antitop quark. If an exotic  $A$  or  $H$  boson exists, the  $t\bar{t}$  spin correlation will differ significantly from the SM expectation. This difference was investigated using an angular helicity variable that explores the projection of the top and antitop quark spins onto each other. This variable enabled us not only to discriminate between signal and background, but also to explore the differences between the  $A$  or  $H$  signal hypotheses.

In the analysis, both the invariant  $t\bar{t}$  mass distribution and the spin correlation angle were investigated. The search covered  $A$  or  $H$  boson masses between 400 and 750 GeV and a total relative width from 0.5 to 25% relative to the mass. Figure 1 shows the  $t\bar{t}$  mass distribution for five different bins of the angular distribution. The data is compared to the SM prediction (upper row). The difference between the data and the SM prediction is shown in the lower row. For illustration, we added the contribution from the presence of an  $A$  boson at 400 GeV and a relative width of 5% (red histogram).

Constraints were set on the coupling strength between the  $A$  or  $H$  bosons, respectively, and the top quark. Figure 2 shows upper limits on the  $A t\bar{t}$  coupling strength as a function of the  $A$  boson mass for the case of 5% total relative width, combining dilepton and single-lepton final states. The observed constraint is weaker than the expected limit around an  $A$  boson mass of 400 GeV. This corresponds to the deviation observed between the data and the SM prediction in the  $t\bar{t}$  mass distribution, particularly at high values of the helicity angle, that is compatible with a pseudoscalar Higgs boson signal with a mass of 400 GeV (Fig. 1). The local significance of the effect was 3.5 standard deviations. However, accounting for the look-elsewhere effect, the

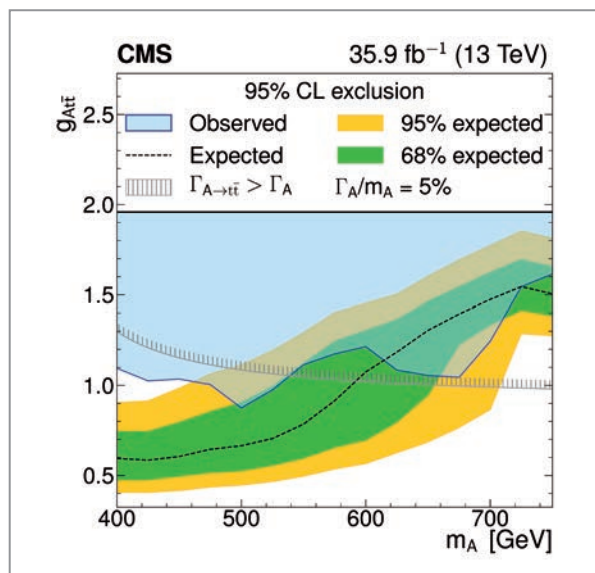


Figure 2

Constraints on the coupling strength between the pseudoscalar boson and the top quark as a function of pseudoscalar mass, assuming a total relative width of 5%. The limit expected in the SM (dashed curve), including uncertainties at the 68% (95%) confidence level indicated by the green (yellow and green) band, are compared to the observed limit in the data (blue shaded area). The unphysical region of phase space deduced from considerations of the total  $A$  boson width was added (grey hatched line).

significance of the signal-like deviation was 1.9 standard deviations. We therefore concluded that the current data set shows agreement with the SM prediction.

## Summary and outlook

In a search for heavy scalar and pseudoscalar Higgs bosons decaying into a pair of top and antitop quarks, evidence for a local excess was observed for the production of a pseudoscalar Higgs boson at a mass of 400 GeV. However, the global analysis agrees with the SM prediction. To find out whether the deviation is a first hint of new physics beyond the SM or not, the full  $137 \text{ fb}^{-1}$  of data taken during LHC Run 2 will be used in a future update of this analysis, and new search strategies will be explored. In addition, improved theoretical predictions for both the background and signal processes, in particular within the mass region of deviation, will be necessary to clarify the origin of this excess, if it remains. The DESY CMS group will continue to be at the forefront to stress-test the compatibility between the data and the SM and to find out if the data indeed hint at new phenomena.

### Contact:

Afiq Anuar, [afiq.anuar@desy.de](mailto:afiq.anuar@desy.de)  
 Alexander Grohsjean, [alexander.grohsjean@desy.de](mailto:alexander.grohsjean@desy.de)  
 Christian Schwanenberger, [christian.schwanenberger@desy.de](mailto:christian.schwanenberger@desy.de)

### References:

[1] CMS Collaboration, “Search for heavy Higgs bosons decaying to a top quark pair in proton-proton collisions at  $\sqrt{s}=13 \text{ TeV}$ ”, arXiv:1908.01115 [hep-ex], accepted by JHEP

# Detector upgrades for the HL-LHC

Faster silicon detectors for brighter data

In preparation for the high-luminosity phase of the LHC (HL-LHC), which is due to start in 2027, the ATLAS and CMS collaborations are working on upgrading their detectors. The DESY ATLAS and CMS groups are strongly involved in the development, design, construction and installation of the new silicon tracking detectors. The year 2019 marked the coming-to-life of the infrastructure: More than 1000 m<sup>3</sup> of cleanroom space at the two DESY sites in Hamburg and Zeuthen were commissioned and filled with nearly all the required infrastructure, including thin-wire bonding machines and several ultrahigh-precision robots.

## New particle detectors for ATLAS and CMS

While CERN is preparing for the high-luminosity upgrade of the LHC, among other things with accelerator construction and underground tunnel boring, DESY is getting ready to build a significant part of the tracking detectors for both the ATLAS and CMS experiment. One of the end-caps for each experiment will be assembled at DESY. After a long period of specification iterations, procurement and finally construction, the cleanrooms became available on the DESY Hamburg and Zeuthen sites and were used to assemble first detector parts (see Fig. 2 for a peek ahead at the first fully loaded electrical detector structure at DESY for the ATLAS upgrade).

## Six strip detector disks for ATLAS

The ATLAS group spans the two DESY sites, with group members at both sites performing detector development, design and construction in close cooperation. The

cleanrooms were set up in the same spirit. They provide humidity- and temperature-controlled clean-air (ISO-6 and ISO-7) areas for the safe assembly of all electronic and mechanical detector components.

The cleanrooms in Zeuthen and Hamburg are used to construct and test silicon strip detector modules for the ATLAS upgrade. The modules are composed of a silicon sensor (~5000 n-in-p channels on ~10 x 10 cm<sup>2</sup> of p-bulk silicon), a readout flex board loaded with amplifier application-specific integrated circuits (ASICs) and a power converter board. The module components are precision-glued, wire-bonded (about 6000 wire bonds per module) and then exposed to stringent quality control tests. These tests include micrometre-precise measurements of geometric tolerances as well as electrical functionality and performance tests. A special focus also lies on thermal cycling and burn-in tests as well as on long-term stability tests. The extremely harsh radiation environment



**Figure 1**  
Cleanroom for ATLAS strip detector module construction at the DESY Zeuthen site



expected at the HL-LHC greatly influenced the module design and choice of materials.

All modules meeting the tight ATLAS specifications are then assembled into detector subcomponents called petals (32 petals will form one of the six end-cap disks). Figure 2 shows the first petal that was fully loaded at DESY. It contains one fully functional electrical module with a production quality silicon sensor (at the narrow end) and five further modules with dummy silicon “sensors” and functional electrical readout structures including front-end ASICs.

The modules were precision-placed on the carbon fibre support core using a robotic gantry – the placement accuracy for this first full run was better than 40  $\mu\text{m}$ , which is expected to further improve with production quality modules. The full assembly will be electrically tested and used as a further demonstration of the system’s robustness. The central readout card at the “ear” of the petal plays a crucial role and is designed and built at DESY. Furthermore, DESY is developing and testing the carbon fibre support structures of the petals. To test the electrical connections on the petal support structure, an automated testing robot has been constructed and is currently being calibrated.

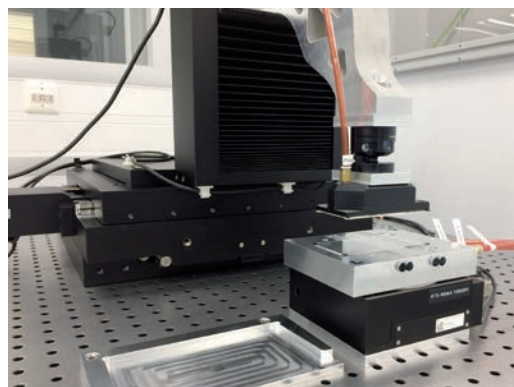
## High-precision assembly of silicon detectors for the CMS tracker

DESY also plays a leading role in the construction of the next tracking detector for the CMS experiment. The CMS group at DESY contributes to several aspects of the outer tracker upgrade, from the assembly of the individual modules that make up the detector to the mechanics of its overall structure. The upgraded CMS outer tracker will be composed of several thousand silicon detector modules, each either 10 x 5  $\text{cm}^2$  or 10 x 10  $\text{cm}^2$  in size and a few millimetres thick (the exact dimensions depend on the type of module). 1250 of these modules will be assembled at DESY.

At the core of each module, two closely spaced silicon sensors will record the passage of charged particles produced in the LHC collisions. This new double-layered module design will allow the signals of the two sensors to be correlated in real time and the reconstruction of charged particles to be performed with unprecedented speed, ultimately improving the physics reach of the entire experiment. At the same time, the new functionality poses stringent requirements on the precision of the module assembly; as an example, for every module, the maximum rotational misalignment between the two sensors must be smaller than 45 millidegrees (or even less, for certain modules). To meet this challenge, the DESY CMS group has developed a new procedure for the automated assembly of the modules (Fig. 3). The chosen method relies on an integrated system based on a programmable motion stage equipped with a high-resolution camera. The camera is used to take images of the sensors’ fiducial markers. By means of a pattern recognition technique, these images are converted into a



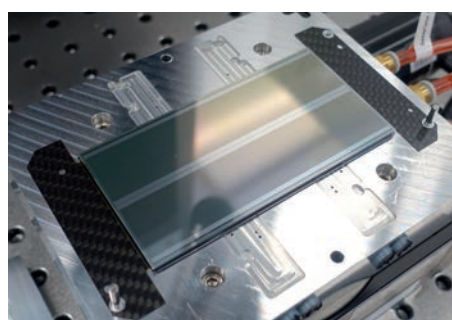
**Figure 2**  
First fully module-loaded detector structure for the ATLAS upgrade at DESY



**Figure 3**  
Automated pickup and positioning system for the CMS detector module assembly

measurement of the sensors’ positions. Based on these measurements, the motion stage can be used to arrange the sensors with high precision with respect to each other and to the other assembly parts.

A special glue application technique was developed to allow at the same time the use of a fast-curing glue, the quick handling of the module and the use of a slow-curing glue, for long-term stability and radiation hardness. The assembly procedure was developed and validated by building several glass-based prototypes able to meet the specifications of the CMS outer tracker modules in terms of both assembly time and mechanical precision. After this, the same procedure was successfully applied to assemble the first pixel sensor module mechanical prototype with silicon parts (Fig. 4). Next, this module will be equipped with dummy readout hybrids, followed by a bonding exercise to validate the full production process.



**Figure 4**  
First pixel sensor module mechanical prototype assembled at DESY with silicon parts

### Contact:

Ingo Bloch, [ingo.bloch@desy.de](mailto:ingo.bloch@desy.de)  
Sergio Diez Cornell, [sergio.diez.cornell@desy.de](mailto:sergio.diez.cornell@desy.de)  
Marino Missiroli, [marino.missiroli@desy.de](mailto:marino.missiroli@desy.de)  
Guthoff, Moritz, [moritz.guthoff@desy.de](mailto:moritz.guthoff@desy.de)

# (Charge) sharing is caring

New concepts for high-precision sensors at future colliders

Vertex detectors at future linear colliders are required to feature a position resolution of about  $3\ \mu\text{m}$  in combination with a time resolution of down to  $5\ \text{ns}$ , while their thickness is limited to about  $50\ \mu\text{m}$ . This unprecedented combination of requirements is addressed by a new sensor concept developed by the DESY CMS group. The sensor bulk features a non-homogeneous lateral electric field, resulting in a position-dependent charge sharing. Thereby, the spatial resolution of the impact position of ionising particles is greatly improved compared to standard planar sensors.

## Why and how to share charge

The spatial resolution of the impact position of minimum ionising particles (MIP) is usually improved by miniaturising the pixel or strip pitch of a sensor. The pitch describes the distance between two readout entities, and smaller pitches allow for a more precise measurement of the impact position. Additionally, a non-perpendicular incidence of the MIP or a strong magnetic field can render a higher resolution possible. However, these methods fail for sensors with a thickness below about  $100\ \mu\text{m}$ .

If the charge produced by a MIP in the sensor is collected by two readout entities, the impact position can be interpolated more precisely. Following this approach, the DESY CMS group has developed a dedicated charge-sharing mechanism that acts inside the sensor bulk. The enhanced lateral drift (ELAD) sensor concept is realised by local modifications of the electric field in the sensor bulk, yielding a position-dependent charge collection at two electrodes. This approach is also feasible for thin detectors down to  $50\ \mu\text{m}$  thickness.

The design of an ELAD sensor is shown in Fig. 1, left. The buried implants form a p-n-p structure creating a lateral electric field component that influences the path of the charge carriers along their drift to the readout entities. The buried implants are sandwiched between epitaxially grown layers of silicon. Using Monte Carlo simulations, the resolution of ELAD sensors is evaluated as the root mean square of the difference between the true position and the interpolated position. At a pitch of  $55\ \mu\text{m}$ , the ELAD sensor shows an almost three times better position resolution than a standard sensor (Fig. 1, right).

A dedicated production process was developed at Fraunhofer EMFT in Munich, Germany, showing promising

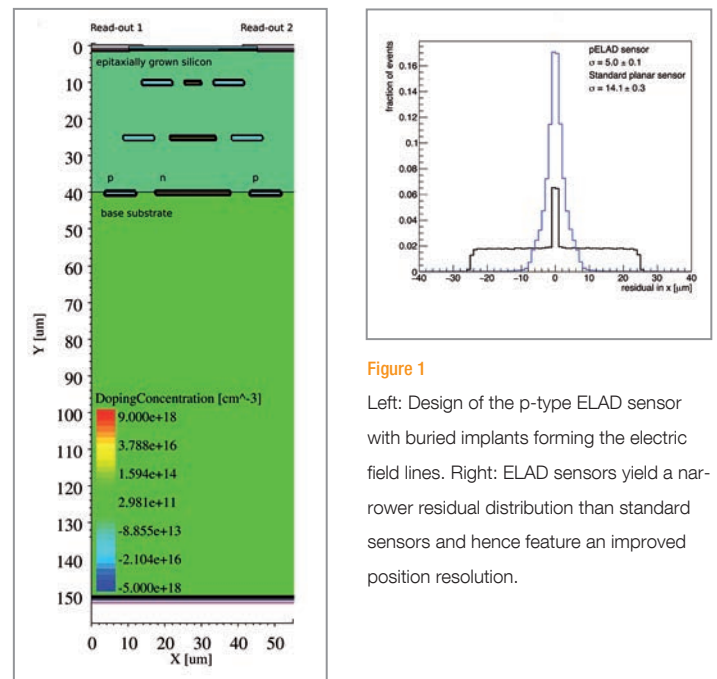


Figure 1

Left: Design of the p-type ELAD sensor with buried implants forming the electric field lines. Right: ELAD sensors yield a narrower residual distribution than standard sensors and hence feature an improved position resolution.

performance. The first ELAD sensor prototypes are currently under production, with results expected in the second half of 2020. Measurements at the DESY II Test Beam Facility will demonstrate the full potential of ELAD sensors.

### Contact:

Doris Eckstein, [doris.eckstein@desy.de](mailto:doris.eckstein@desy.de)  
Hendrik Jansen, [hendrik.jansen@desy.de](mailto:hendrik.jansen@desy.de)  
Anastasiia Velyka, [anastasiia.velyka@desy.de](mailto:anastasiia.velyka@desy.de)

### References:

- [1] H. Jansen, NIM A 831 (1), 242–245 (2016)
- [2] A. Velyka, H. Jansen, JINST 14 (05), C05005 (2019)



# “Weak light sabres” to probe nature

Probing the rarest processes of the Standard Model of particle physics

In the Standard Model (SM) of particle physics, the Higgs field is responsible for the mass of elementary particles. The mechanism of electroweak symmetry breaking (EWSB) explains how the Higgs field gives mass to the  $W$  and  $Z$  vector bosons. Since the discovery of the Higgs boson in 2012, the investigation of EWSB has been a priority at the LHC. One major step towards this goal is the study of the scattering of two vector bosons, known as vector boson scattering (VBS). New milestones were recently reached with the ATLAS collaboration observing all VBS processes involving the  $W$  and  $Z$  bosons. DESY scientists played a major role in these observations.

VBS is one of several electroweak processes that produce a pair of  $W^\pm$  or  $Z$  bosons in association with two jets (narrow cones of hadrons and other particles originating from a quark). In VBS events, these jets are produced preferentially along the proton beams and opposite to each other.

Without the Higgs boson, the rate of occurrence of VBS processes would grow indefinitely with the energy of the collision. According to the SM, EWSB should precisely cancel out this uncontrolled growth. New physics beyond the SM could influence the rate of VBS processes at high energy, which is why precise measurements of these processes are an important objective for the LHC experiments.

The ATLAS collaboration recently observed the production of two jets in association with (a) a pair of  $W$  bosons with the same charge ( $W^\pm W^\pm jj$ ) [1]; (b) a  $W^\pm Z$  pair ( $W^\pm Z jj$ ) [2]; and (c) a  $Z$  boson pair ( $ZZ jj$ ) [3]. Moreover, ATLAS physicists established evidence of the production of two jets in association with a  $Z$  boson and a photon ( $Z \gamma jj$ ) [4]. The observation of the latter would complete the observation of all the VBS processes involving the force carriers of the electromagnetic ( $\gamma$ ) and weak ( $W^\pm$  and  $Z$ ) interactions. These measurements were performed with events where the vector bosons decay into leptons (electron or muon). ATLAS physicists also probed  $VVjj$  production ( $V = W^\pm$  or  $Z$ ) in events where one of the vector bosons decays to leptons and the other to quarks (yielding two additional jets in the event) [5].

To achieve the observation of the very rare  $W^\pm Z jj$  and  $ZZ jj$  processes, the analysers aggregated information from various sources using machine learning (boosted decision trees, BDT, in this instance). Figure 1 shows the BDT score in the signal region, where the production rate was measured.

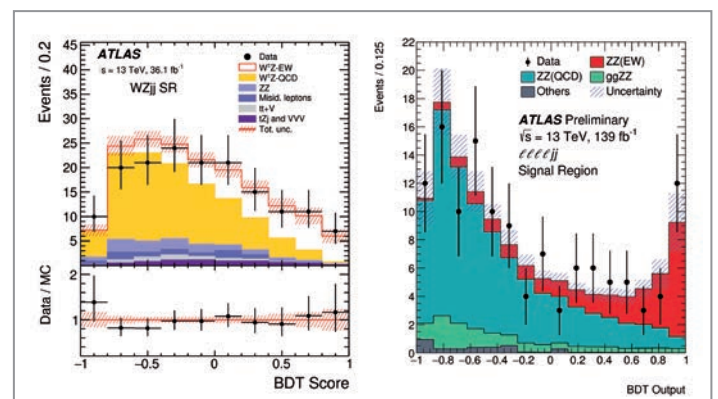


Figure 1

Distribution of events according to the boosted decision tree (BDT) score in the signal regions of the  $W^\pm Z jj$  (left) and  $ZZ jj$  (right) analyses

Several DESY scientists had a leading role in these measurements, and they intend to continue to contribute to the understanding of EWSB. The next steps include precisely measuring the VBS production rates in various regions of phase space and probing the longitudinal polarisation components of the vector bosons, which arise from EWSB.

## Contact:

Karolos Potamianos, karolos.potamianos@desy.de  
James Ferrando, james.ferrando@desy.de

## References:

- [1] ATLAS Collaboration, Phys. Rev. Lett. 123, 161801 (2019)
- [2] ATLAS Collaboration, Phys. Lett. B 793, 469 (2019)
- [3] ATLAS Collaboration, ATLAS-CONF-2019-033
- [4] ATLAS Collaboration, Phys. Lett. B 803, 135341 (2020)
- [5] ATLAS Collaboration, Phys. Rev. D 100, 032007 (2019)

# Dial T for Telescope

A new beam telescope is earning its stripes

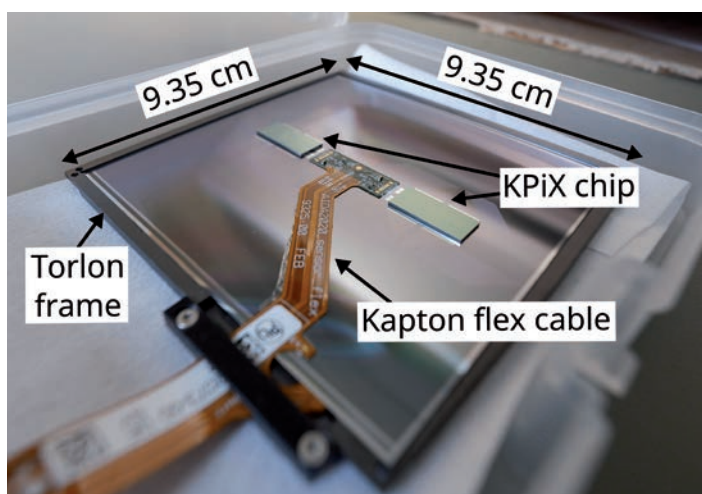
Area T24/1 at the DESY II Test Beam Facility hosts a special infrastructure: a superconducting solenoid for testing large devices under test (DUT) with a diameter of up to 75 cm in a magnetic field of 1 T. To fully assess the performance of a DUT, a precise reference measurement of particle trajectories within this magnet is essential. In close collaboration with SLAC, DESY is developing a beam telescope with three layers of silicon strip sensors before and three behind the DUT. Over the last years, many tests were performed in the laboratory and on site at the test beam. As the results demonstrate, the new telescope is nearing completion and its final commissioning as a user infrastructure is close.

The DESY II Test Beam Facility [1] houses a special setup, mounted on a movable stage, for testing large detector prototypes in a strong magnetic field of up to 1 T. At its heart is a superconducting solenoid magnet with a usable inner diameter of about 85 cm, in which detector prototypes with a diameter of up to 75 cm can be assessed. Many groups, for example from the Belle II experiment, the ATLAS upgrade efforts or the LCTPC and T2K time projection chamber (TPC) developments, have been testing their prototypes using this unique infrastructure.

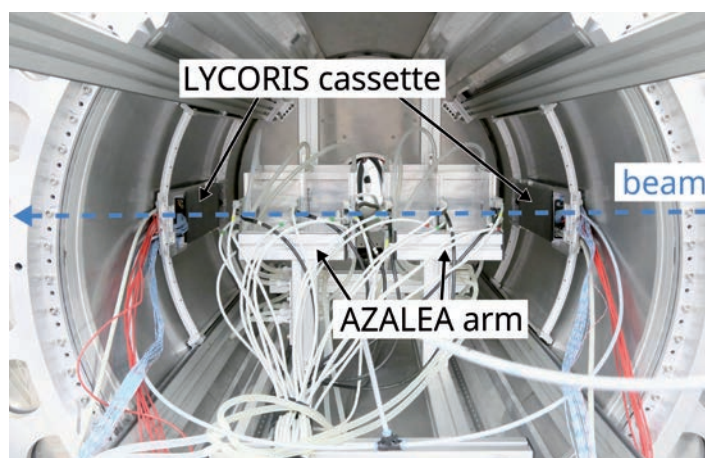
To complete the setup, the installation of a new beam telescope as an external precision reference is in progress. For the prototype tests, the particle trajectories inside the magnet have to be known precisely. Since the trajectories are affected by scattering processes in the wall and coil of the magnet, the telescope has to be installed inside the magnet

right next to the DUT. The challenges are that the available space is limited to only about 3.5 cm, that the telescope is allowed to contribute only little material itself and that it has to provide a point resolution of better than 10  $\mu\text{m}$  in the bending direction of the trajectory in the magnetic field. Since the telescope is to be used as a general infrastructure, it is designed in such a way that it can also be used outside the magnet, providing large-area tracking coverage, for example for calorimeter tests.

Standard sensors as they are currently used in experiments like ATLAS or CMS could not fulfill the stringent requirements listed above. Hence, the new telescope – named LYCORIS – is based on novel hybrid-less silicon strip sensors (Fig. 1). Like the two KPiX [2] application-specific integrated circuits (ASICs) used for their readout, the sensors were originally developed at SLAC for the SiD detector concept. They have



**Figure 1**  
Framed silicon strip sensor with two bump-bonded KPiX readout chips and attached Kapton flex readout cable



**Figure 2**  
Measurement setup inside the 1 T solenoid, including the two LYCORIS cassettes on the left and right side as well as the EUDET-type AZALEA telescope as reference tracker in the centre



strips with a pitch of 25  $\mu\text{m}$ , with every second strip being read out. This results in a hit resolution of about 7  $\mu\text{m}$ . The active area of a sensor plane measures 9.35 x 9.35  $\text{cm}^2$ .

The KPiX is bump-bonded directly to the integrated pitch adapter on the sensor, which connects the strips to the ASICs. The bump bonding was performed at Fraunhofer IZM in Berlin, while the wire bonding of the Kapton flex readout cable to the KPiX was done by the DESY service centre electronics in Hamburg (ZE).

The sensors are mounted in Torlon frames, which are mounted in three layers with two sensors each in cassettes, one of which is installed in front and one behind the DUT. The cassettes are only 3.3 cm thick to fit into the narrow space between the DUT and the magnet wall. The material budget of a fully equipped cassette adds up to only about 1% of a radiation length  $X_0$ . In the mounting structure, the cassettes can be moved along the magnetic field axis and rotated around the DUT.

All components of the mounting system and readout system – including interface and data acquisition boards developed at SLAC – are available. In 2019, extensive tests were performed in the laboratory and at the DESY test beam. Figure 2 shows the two LYCORIS cassettes mounted in the solenoid magnet with the EUDET-type AZALEA telescope [3] installed as reference tracker in the centre.

Figure 3 presents a correlation plot between two of the sensor planes in the test beam. Compared to 2018, the overall noise in the data could be greatly reduced and the correlation is more clearly visible. The studies indicate that the average signal charge is 2.6 fC, while the average noise level is 0.2 fC, which results in a good signal-to-noise ratio of  $S/N = 13$ . This value is expected to be further improved by optimising the sampling of the charge signal.

In addition to the measurements inside the solenoid magnet, tests were performed in another test beam area without magnetic field, where one LYCORIS cassette was mounted between the two arms of the AZALEA reference telescope. The reconstruction of the events was performed using the General Broken Lines (GBL) [4] software package and the alignment using the Millepede II [5] tool. Figure 4 features a reconstructed event from this setup, which clearly shows that the hits on the LYCORIS planes fit well to the tracks reconstructed from AZALEA. Both telescopes were fully synchronised, demonstrating that setups that work together with an EUDET-type telescope can also easily be combined with the LYCORIS system.

From the test measurements, the required point resolution of better than 7  $\mu\text{m}$  for the LYCORIS sensor planes could be confirmed. A first look at the resulting momentum resolution showed that this too agreed with the requirement of about  $5 \times 10^{-6} \text{ MeV}^{-1}$ .

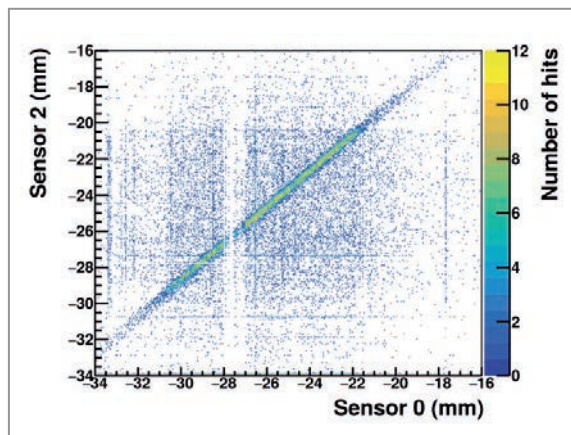


Figure 3

Measured beam position: Correlation between two sensor planes

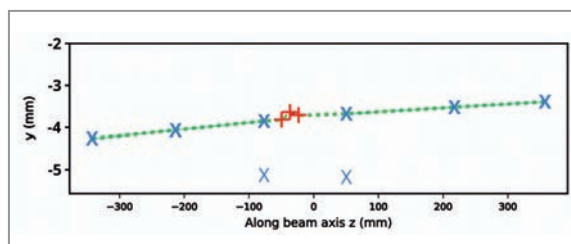


Figure 4

Event display: The hits in the AZALEA telescope are shown as blue crosses and the corresponding triplet tracks as lines. The LYCORIS hits are marked as red pluses and the combined track as a green dotted line.

The tests performed in 2019 clearly confirmed that the LYCORIS telescope meets the required specifications and demonstrated its usability. In 2020, the telescope studies will be continued in more detail. Together with the associated software, the system will be further developed in order to finally transform the setup into a user infrastructure at the DESY II test beam.

This project is pursued in close collaboration by the DESY ATLAS and FLC groups and SLAC. It is strongly supported by the DESY FE and ZE groups as well as by the European Horizon 2020 project AIDA-2020, GA no. 654168.

#### Contact:

Uwe Krämer, [uwe.kraemer@desy.de](mailto:uwe.kraemer@desy.de)  
Mengqing Wu, [mengqing.wu@desy.de](mailto:mengqing.wu@desy.de)

#### References:

- [1] The DESY II test beam facility, NIMA 922, 265–286 (2019), DOI: 10.1016/j.nima.2018.11.133
- [2] KPiX – A 1,024 channel readout ASIC for the ILC, IEEE NSS/MIC (2012), DOI: 10.1109/NSSMIC.2012.6551433
- [3] Performance of the EUDET-type beam telescopes, EPJ Techn. Instrum. 3, 7 (2016), DOI: 10.1140/epjti/s40485-016-0033-2
- [4] General Broken Lines as advanced track fitting method, NIMA 673, 107–110 (2012), DOI: 10.1016/j.nima.2012.01.024
- [5] Software alignment for Tracking Detectors, NIMA 566, 5–13 (2006), DOI: 10.1016/j.nima.2006.05.157

# Science at a Higgs factory

## Shaping the next collider

A new high-energy electron–positron ( $e^+e^-$ ) collider, operating as a Higgs boson factory with a minimum centre-of-mass energy of 250 GeV, could be the next big project in particle physics. In 2019, four such projects were discussed on the way towards the next update of the European Strategy for Particle Physics, which is expected to be published in 2020. DESY has been a key player in laying out the scientific foundations for these discussions, based on careful projections of important measurements and on their interpretation in the context of the Standard Model (SM) of particle physics – and beyond. Particular emphasis was put on evaluating the interplay of beam polarisation and luminosity.

### Higgs factories around the world

Discovered only in 2012 at the LHC, the Higgs boson is the youngest member of the particle family, but maybe the longest sought for. Since its discovery, we have learned a lot about the new kid on the block from the LHC, but still many questions remain: Is the Higgs boson really an elementary particle, the only one without spin, or rather a composite object? Why does it have such a special relation to the top quark, making the latter as heavy as a gold atom? Does the Higgs boson act as a portal to a whole dark sector, explaining the cosmologically observed dark matter?

In order to address these and many other questions, four different  $e^+e^-$  colliders have been proposed: the circular colliders CEPC in China and FCCee at CERN as well as the linear colliders ILC in Japan and CLIC at CERN. Figure 1 shows the instantaneous luminosity of these projects as a function of the collision energy. While the circular colliders offer unrivalled luminosities at energies below 250 GeV, they cannot be upgraded later on to reach higher energies. This energy upgradability and the ability to collide longitudinally polarised beams are unique features of linear colliders.

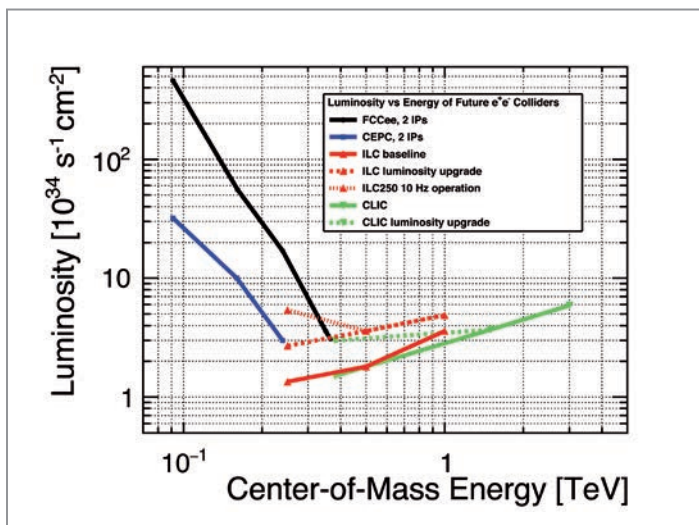


Figure 1 Luminosity as a function of centre-of-mass energy of future  $e^+e^-$  colliders. From [1].

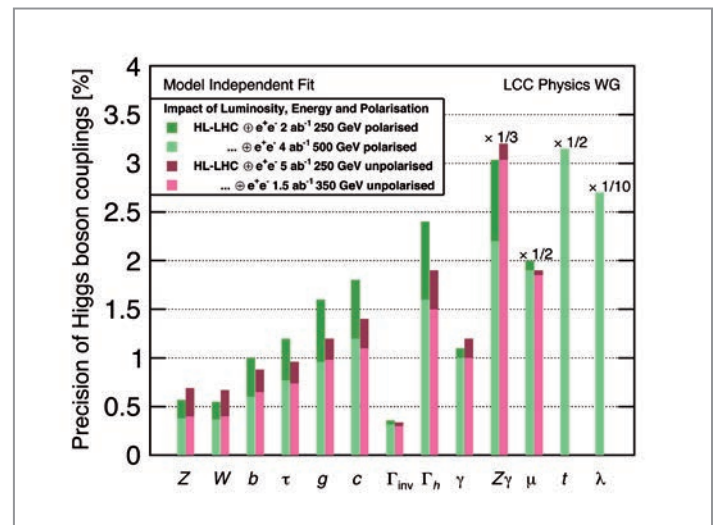
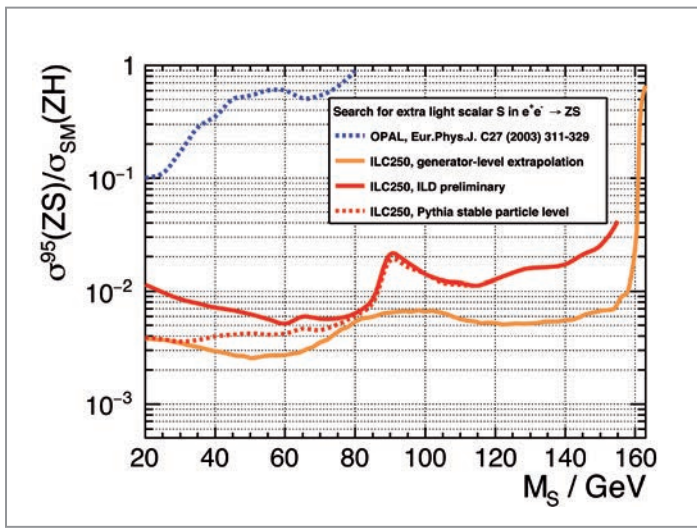


Figure 2 Interplay of luminosity, beam polarisation and energy at future  $e^+e^-$  Higgs factories: At 250 GeV, 2  $ab^{-1}$  of polarised data (green) yield very similar precisions to 5  $ab^{-1}$  of unpolarised data (red). The couplings of the Higgs boson to the top quark and to itself are only accessible at centre-of-mass energies of at least 500 GeV. From [1].





**Figure 3**  
Searches for additional scalar (Higgs) bosons with strongly reduced coupling to the Z boson. Current limit from OPAL (blue) and projections for the ILC at 250 GeV: generator-level extrapolation of the OPAL limit [2] and result of the ILD full detector simulation study [3].

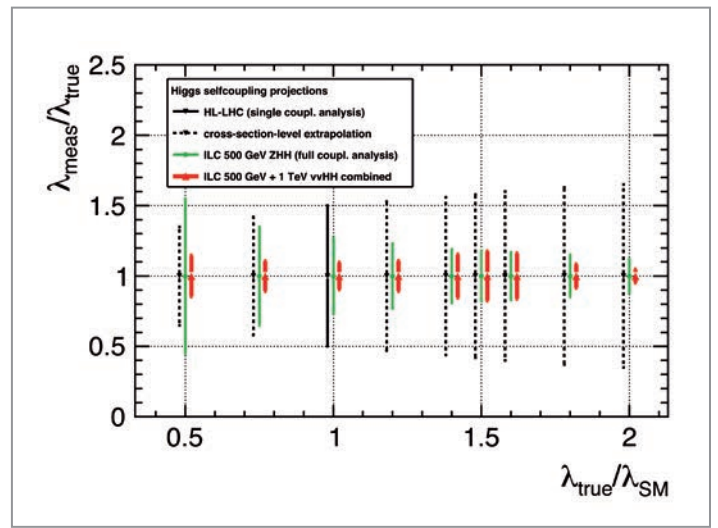
## Luminosity, energy and beam polarisation

While each project has its own strengths, the key scientific question – which DESY scientists have addressed together with their colleagues around the world – is how these complementary properties impact the prospects for a precision profiling of the Higgs boson.

Figure 2 shows the expected precisions on the couplings of the Higgs boson to various SM particles, including itself, on its total width as well as the 95% confidence level sensitivity to Higgs decays into exotic “invisible” particles. The red and green bars correspond to assumptions on the luminosity, beam polarisation and collision energy typical for circular and linear colliders, respectively. For most observables, the higher luminosity at the circular colliders is approximately compensated by the polarised beams at linear colliders. The couplings of the Higgs boson to the top quark and to itself can only be accessed at energies of at least 500 GeV.

## Searching for siblings of the Higgs

Higgs factories will also offer a unique potential to search for siblings of the Higgs bosons, for instance in decays of the Higgs boson itself, or when radiated off heavy quarks, or in direct production together with a Z boson. In the latter case, the search can be performed in such a way that it is agnostic to the – *a priori* unknown – decay modes of the new Higgs boson, or, more generally speaking, the new scalar  $S$ . In  $e^+e^-$  collisions, the full four-momentum of the initial state is known and thus the four-momentum recoiling against the decay products of the Z boson can be calculated. An extra Higgs boson would then show up as a peak in the recoil mass spectrum.



**Figure 4**  
Prospects for the measurement of the Higgs self-coupling depending on its value (normalised to the SM prediction): The black error bars show a cross-section-level extrapolation of the HL-LHC projection, which only exists for the SM case. The green and red bars show the ILC projections at 500 GeV alone and combined with 1 TeV, respectively.

Figure 3 compares the sensitivity of the 250 GeV ILC to the existing exclusion bound from the OPAL experiment at CERN’s former LEP collider, which still provides the most up-to-date constraint. Areas above the curves are excluded. The yellow curve is a theory extrapolation [2] of the OPAL limit to ILC conditions, while the red curve has been obtained in a full, Geant4-based detector simulation study performed at DESY [3]. The dashed curve indicates the potential improvement if more advanced reconstruction algorithms to identify additional photons from initial-state radiation would be developed.

## Learning more at higher energies

If the energy of the Higgs factory could be extended to 500 GeV and 1 TeV, two measurements of di-Higgs production would become accessible, which provide important information on the coupling of the Higgs boson to itself. The behaviour of these two measurements in extensions of the SM, where the value of the self-coupling  $\lambda$  could deviate substantially from the SM prediction, are highly complementary to each other and to the measurement at the High-Luminosity LHC (HL-LHC), as illustrated in Figure 4.

### Contact:

Jenny List, [jenny.list@desy.de](mailto:jenny.list@desy.de)

### References:

- [1] P. Bambade et al., The International Linear Collider: A Global Project, DESY-19-037, arXiv:1903.01629 [hep-ex]
- [2] P. Drechsel et al., Sensitivity of the ILC to light Higgs masses, DESY-17-193, arXiv:1801.09662 [hep-ph]
- [3] Y. Wang et al., Search for Extra Scalars Produced in Association with Muon Pairs at the ILC, arXiv:1902.06118 [hep-ex]

# Machine learning for fast shower simulation

Can artificial intelligence beat detailed physics modelling?

Data analysis in high-energy physics (HEP) relies heavily on the detailed simulation, using Monte Carlo methods, of the detector response to particles created in the physics interactions. These methods are based on the extremely accurate modelling of the relevant physical effects that lead to the electronic signals seen in the detector. The modelling of these effects poses dramatic requirements on the needed CPU resources. Recent advancements in the field of artificial intelligence and machine learning (ML) suggest that it might be possible to create 3D physics signals in the detector that are indistinguishable from the ones created with the detailed physics models – in orders of magnitude shorter computing times. To explore this exciting possibility, the DESY FLC group started a project investigating the use of ML techniques to speed up the simulation of electromagnetic showers in highly granular calorimeters as they are foreseen for most future Higgs factories.

## Introduction

The detailed and accurate simulation of physics interactions in particle detectors using Monte Carlo techniques is an indispensable tool in HEP. This is the case for the whole lifetime of a project, starting from the first conceptual designs for a new detector through the engineering R&D phase to the period of real data taking and analysis. Of particular importance is the exact modelling of the interaction of particles with matter, which results in the electronic signals that are eventually measured in the detector. This modelling is typically done with the Geant4 toolkit, which has been used in HEP for more than two decades and which provides algorithms based on the best knowledge of the underlying physics processes.

While these algorithms are very accurate and provide the required precision, they also demand tremendous computing resources. Roughly 40% of the total CPU time that is needed for the ATLAS and CMS experiments at the LHC is used for this type of Monte Carlo simulation with Geant4. By far the largest fraction of this time is required for the simulation of particles showering in the calorimeters, where the particle energy is measured from the decay products. Speeding up this simulation time significantly – at no loss of physics precision – could dramatically improve the scientific yield, at lower or constant cost.

## Machine learning and generative adversarial networks

The field of artificial intelligence that deals with ML has gained enormous attention in recent years, the prominent examples being autonomously driving cars or computers

beating the world's best Go players. A special subfield of ML deals with generative methods, which are trained to create realistically looking artificial images based on unsupervised learning from a set of suitable example images. This is used for instance to create fashion photos without a real model. The state-of-the-art method for this approach is provided by generative adversarial networks (GANs), in which a generator network and a critic (adversarial) network are trained at the same time. While the generator is trained to create realistic images, the critic is optimised to distinguish these from real images, providing a feedback loop that improves the generation quality (Fig. 1).

## Fast shower simulation with GANs

Some groups have already applied GANs to calorimeter shower simulation [1, 2], showing promising first results. In

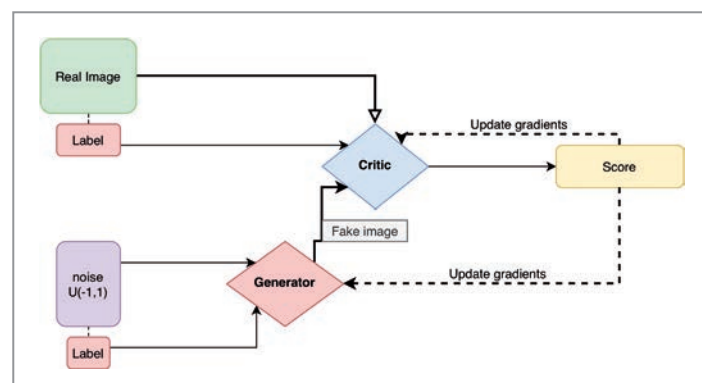
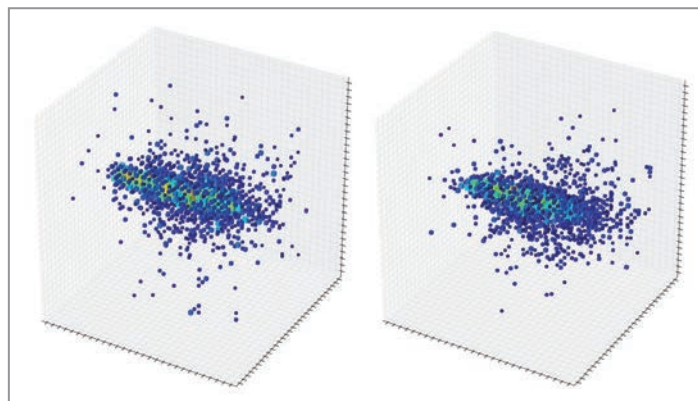


Figure 1  
Schematic view of a generative adversarial network (GAN)



Figure 2

3D images of electromagnetic showers created by a 50 GeV photon in a highly granular Si-W calorimeter with 5 x 5 mm<sup>2</sup> cell sizes.  
Left: Simulated with Geant4.  
Right: Generated with a GAN-like network.



2019, the DESY FLC group started a project together with Universität Hamburg in the context of the cluster of excellence “Quantum Universe” and the Helmholtz Innovation Pool project AMALEA to systematically investigate the suitability of ML methods for fast shower simulation in highly granular calorimeters as they are foreseen for most future Higgs factories. The high granularity of these calorimeters reveals many details of electromagnetic and hadronic showers, posing an additional challenge to the accuracy and quality of the simulation. Several network architectures, such as GAN, WGAN, VAE etc., are being investigated, optimised and compared. Generating 3D images of electromagnetic showers that are indistinguishable to the human eye from those simulated with detailed physics modelling in Geant4 is rather straightforward, as shown in Fig. 2. This is possible with all generative network architectures under study.

## Getting the physics right

To be applicable in real particle physics experiments, however, the generative ML methods have to be able to generate calorimeter showers that are indistinguishable from those simulated with Geant4 (or better, those actually measured in a real detector) to the trained physicist. For this to be the case, effectively all conceivable underlying distributions of physical and topological quantities have to be described correctly.

Starting out with a simple example, we simulated 2D images of 50 GeV photons that hit the calorimeter at 90° incident angle, where the energies of the 30 layers in the calorimeter under study were integrated. After training a GAN-like network to generate such 2D shower images, we first compared basic physics distributions of high relevance, such as the radial shower profile, hit occupancies or visible energy. In this scenario, the network behaved very well and the generated images showed almost identical physics distributions compared to those used for the training (Fig. 3).

The next step was to generalise the networks to generate 3D images of showers with random given particle energy. This turned out to be a much harder problem. On the one hand, the training times grew considerably, despite the use of the most modern GPUs available, and on the other hand, it was not yet possible to generate showers that sufficiently reproduced all relevant physics distributions with the accuracy we aimed for.

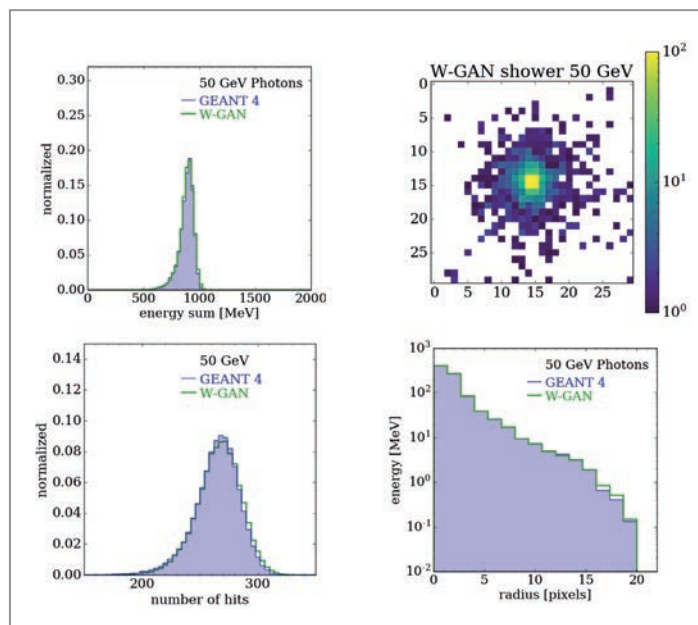


Figure 3

Comparison of various physics distributions of 2D shower images generated with a WGAN to those from realistic physics simulations with Geant4. The network was trained to generate 50 GeV photons only [3].

Artificial intelligence is a very active field of current research in the international HEP community, and we will continue to investigate the exciting possibilities of generative ML techniques for fast shower simulation. The coming years will show whether artificial intelligence will be able to beat the tried and tested, detailed simulations based on extensive physics knowledge of the interaction of particles with matter.

## Contact:

Frank Gaede, frank.gaede@desy.de

## References:

- [1] M. Paganini, L. de Oliveira, B. Nachman, “CaloGAN: Simulating 3D High Energy Particle Showers in Multi-Layer Electromagnetic Calorimeters with Generative Adversarial Networks”, Phys. Rev. D. 97, 014021 (2018)
- [2] M. Erdmann, J. Glombitza, T. Quast, “Precise Simulation of Electromagnetic Calorimeter Showers Using a Wasserstein Generative Adversarial Network”, Computing and Software for Big Science 3, 4 (2019)
- [3] E. Buhmann, S. Diefenbacher, E. Eren, F. Gaede, G. Kasieczka, A. Korol, K. Krüger, “Generative Models for High Granularity Calorimeters”, talk given at ML4Jets 2020

# Belle II Phase 3 has begun

Successful demonstration of nanobeam concept at SuperKEKB

After successful installation of the Belle II vertex detector in the fall of 2018, with major participation of DESY, the first data-taking period of the experiment with all detector systems in place (Phase 3) started in spring 2019 at the SuperKEKB collider at KEK in Japan. An important step on the way to achieving the ambitious design luminosity was the demonstration that the nanobeam concept of beams colliding with a large Piwinski angle worked. The telltale signature is the longitudinal size of the beam spot, which was measured under DESY leadership. DESY also played a key role in proving the great potential of the pixel vertex detector for precision physics by measuring the transverse size of the beam spot. The operation of the SuperKEKB accelerator remained a challenge, however, as beam backgrounds were still very high in many Belle II subdetectors and several unexpected beam losses not only led to quenches of the final focus system, but also caused damage to collimators and parts of the pixel vertex detector. Despite these problems, Belle II collected an integrated luminosity of  $10 \text{ fb}^{-1}$  in the 2019 run period.

## Belle II operation in 2019 and challenges

In 2018, the Belle II detector recorded the first electron-positron collisions at the new SuperKEKB collider. The Belle II vertex detector (VXD), consisting of the four-layer silicon strip vertex detector (SVD) and the two-layer pixel vertex detector (PXD), was installed in autumn 2018. Due to yield issues during the last step of the production (gluing of two modules to form a ladder), only two of the 12 ladders of the outer PXD layer could be installed, while all eight ladders of the innermost layer were completed. In parallel to data taking at KEK, efforts are ongoing within the PXD community to fully replace the detector in the next long shutdown foreseen for 2021/22.

Background in the Belle II subdetectors was still a major concern for beam operation in 2019. In particular, the high current in the central drift chamber and the high photomultiplier tube rates of the time-of-propagation detector limited the achievable beam currents. Another factor limiting the peak luminosity was the vertical emittance blow-up that was observed when trying to collide beams with increased bunch currents. To better understand these and other accelerator-related issues, priority was given to machine studies during the later part of the run after the summer break.

While the present base background level does not yet pose a significant problem for VXD operation, extrapolations to the machine design parameters show that the overall background has to be reduced by at least a factor of 5 to maintain high performance and guarantee safe and long-term operation.

During the spring run, several beam losses occurred in both rings of the accelerator, leading to severe quenches of the

superconducting final focus system and causing damage to collimator heads and to some PXD modules located only 14 mm away from the beamline. In total, 2% of the PXD channels remained inefficient after these accidents. After correcting for this loss, the overall PXD efficiency was well above 98%.

Meanwhile, several measures have been taken to reduce the risk and impact of future beam losses, such as improvements of the beam abort and collimator system on the accelerator side and the implementation of a faster emergency ramp-

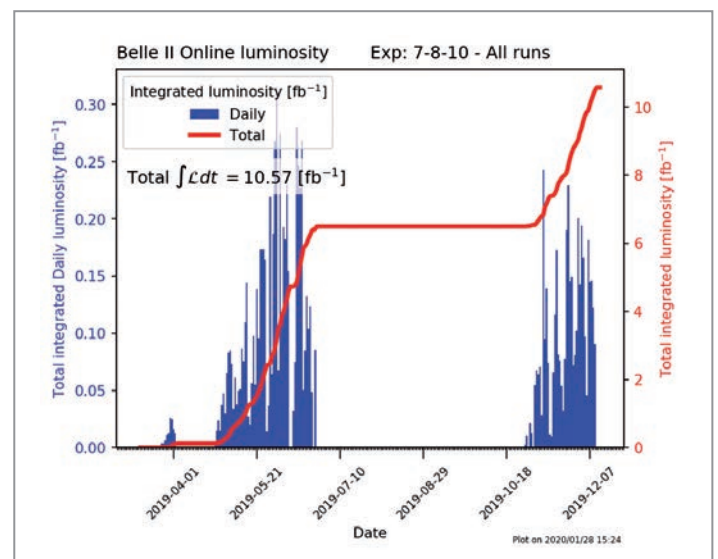


Figure 1

Integrated Belle II luminosity in 2019. The gap in April was due to a fire in the linear accelerator building.



down of the PXD power supplies on the Belle II side. However, since the root cause of these losses is not yet fully understood, such events still represent a significant threat for future operation. Despite all these operational difficulties, Belle II was able to accumulate a total luminosity of more than  $10 \text{ fb}^{-1}$  in 2019, as shown in Fig. 1.

## Verification of nanobeam scheme and VXD performance

The main improvement in instantaneous luminosity of SuperKEKB compared to its predecessor KEKB is expected to come from applying the nanobeam scheme. In this scheme, low-emittance beams are strongly focused in the vertical direction and collide under a large horizontal crossing angle to overcome the otherwise unavoidable dilution from the so-called hourglass effect. The relevant quantity here is a large Piwinski angle  $\Psi \gg 1$  (named after the former DESY accelerator physicist Anton Piwinski), which is the ratio of the longitudinal length of the colliding bunches ( $\sigma_z \sim 6 \text{ mm}$  in the case of SuperKEKB) and the effective length of the overlap region of the two beams  $\sigma_z^{\text{eff}}$  (see insert in Fig. 2, top).

In the 2019 run period, the vertical beta function at the interaction point  $\beta_y^*$  was reduced in steps from  $\beta_y^* = 8 \text{ mm}$  down to  $1 \text{ mm}$ . Comparing this with the DESY measurement of  $\sigma_z^{\text{eff}} \approx 0.35 \text{ mm}$  shown in Fig. 2 (top) proves that the nanobeam condition  $\sigma_z^{\text{eff}} < \beta_y^*$  was indeed satisfied. Under these conditions, a peak recorded luminosity of  $1.14 \times 10^{34} \text{ cm}^{-2}\text{s}^{-1}$  could be achieved, which is slightly larger than the original KEKB design value. For comparison, the ambitious SuperKEKB design goal is  $80 \times 10^{34} \text{ cm}^{-2}\text{s}^{-1}$ .

Another very important quantity is the transverse impact parameter resolution, which plays a decisive role for many key measurements that will be performed at Belle II, such as time-dependent CP violation analyses. One of the consequences of the nanobeam scheme is a very small aspect ratio of the beam spot ellipse in the transverse plane. For  $\beta_y^* = 1 \text{ mm}$ , the vertical size of the beam spot is already more than an order of magnitude smaller than the resolution of the VXD, so the width of the distribution of the “distance of closest approach” to the beam spot  $d_0$ , measured with horizontal tracks, provides a direct measure of the intrinsic VXD resolution.

Figure 2 (bottom) shows the width of this distribution as a function of the emission angle  $\phi_0$  of the tracks. The small discrepancy between the measured intrinsic VXD resolution of  $14.2 \mu\text{m}$  (at  $\phi_0 \approx 0$  or  $\pi$ ) and the Monte Carlo prediction of  $12.5 \mu\text{m}$  is most likely due to too optimistic assumptions on the single-hit resolution in the SVD simulation. By unfolding the measured intrinsic resolution, the horizontal beam spot size can also be extracted; it is in very good agreement with expectations based on the machine optics parameters used in this run. These results also indicate a rather advanced understanding of the detector alignment, which is based on Millepede II [1].

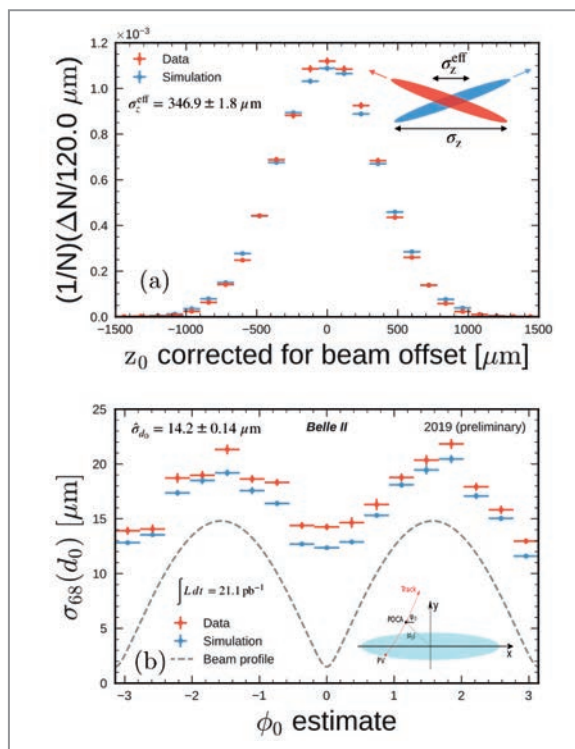


Figure 2

Early Belle II Phase 3 measurements of beam spot properties using the VXD

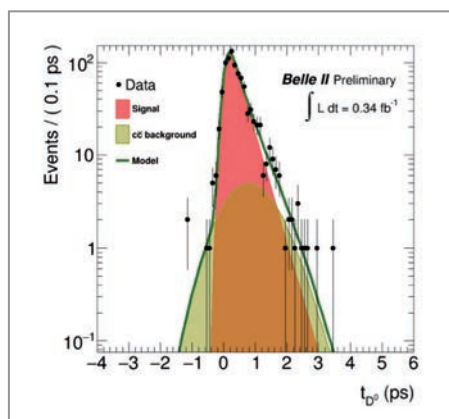


Figure 3

Fit to the reconstructed proper time of the  $D^0$  meson for the decay  $D^* \rightarrow D^0 \pi^+$ ,  $D^0 \rightarrow K^+ \pi^-$

A physics-related variable that was used to demonstrate the very good performance of the VXD already in the early Phase 3 run is the lifetime of the  $D^0$  meson, which relies on the precise measurement of secondary vertices. Figure 3 shows the first preliminary Belle II measurement of this quantity. Within errors, the experimental result of  $\tau = 370 \pm 40 \text{ fs}$  is in good agreement with the Particle Data Group (PDG) value  $\tau_{\text{PDG}} = 410.1 \pm 1.5 \text{ fs}$ .

### Contact:

Alexandre Glazov, alexandre.glazov@desy.de  
Cyrille Praz, cyrille.praz@desy  
Carsten Niebuhr, carsten.niebuhr@desy.de

### References:

[1] Millepede II, V. Blobel, C. Kleinwort,  
<http://www.desy.de/~kleinwrt/MP2/doc/html/index.html>

# Searching for dark matter in Japan

## First results and plans for dark-sector searches with Belle II

A new player in the worldwide efforts to find dark matter has entered the arena: While many experiments have been focusing on rather heavy dark-matter candidates, the Belle II experiment at the SuperKEKB collider in Japan is particularly well suited to search for light candidates in the MeV to GeV range. The DESY Belle II group contributed to the first Belle II physics paper, in which the international collaboration was able to set first limits on invisible decays of a new  $Z'$  boson. In parallel, the DESY Belle II group and the DESY theory group have been working together to design new searches for long-lived particles that appear in various dark-matter models.

### Search for invisible $Z'$ decays

Several open questions in particle physics, including the flavour anomalies in  $b \rightarrow s\mu^+\mu^-$  decays and the anomalous magnetic moment of the muon ( $g - 2)_\mu$ , can potentially be explained by the so-called  $L_\mu - L_\tau$  model. It can mediate interactions to dark matter (DM) if the new particles are charged under  $L_\mu - L_\tau$ . The  $Z'$  couples to the Standard Model (SM) only through the second and third generation of leptons with coupling constant  $g'$ , but not to electrons or electron neutrinos.

The Belle II collaboration has used its small first data set collected in 2018 – corresponding to only 0.001% of the final Belle II luminosity – to search for  $Z'$  production through radiation off a final-state muon (Fig. 1, left) with a subsequent decay into invisible particles.

The DESY Belle II group was involved in the analyses and played a leading role in the performance studies of tracking, particle identification and photon reconstruction in the first data. No significant excess in the dimuon recoil mass was observed (Fig. 2), which allowed Belle II to set world-leading limits for invisible  $Z'$  decays excluding  $g' > 5 \times 10^{-2}$ . The Belle II collaboration also searched for lepton-flavour-

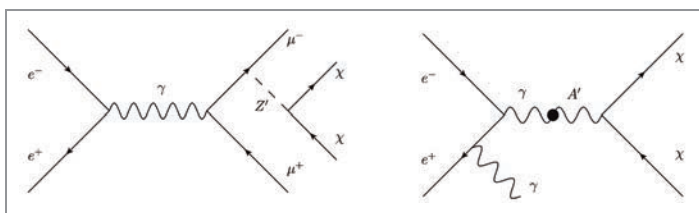
violating  $Z'$  decays into electrons and muons and placed limits on the cross section for this process.

With the full Belle II data set and improved detector understanding, the collaboration plans to improve the coupling limits by almost two orders of magnitude in the future.

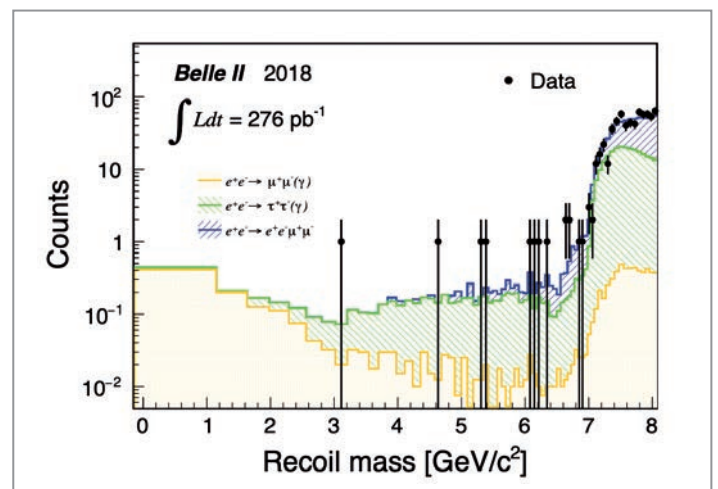
### Search for invisible dark-photon decays

A significant number of experiments have recently published limits for dark photon ( $A'$ ) searches where the  $A'$  decays visibly into charged lepton pairs.

However, if the  $A'$  is not the lightest dark-sector particle, it will dominantly decay into light dark matter  $\chi$  via  $A' \rightarrow \chi\chi$ .

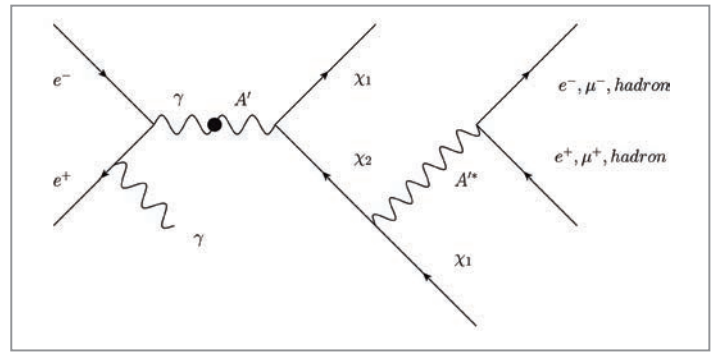


**Figure 1**  
Feynman diagrams for  $Z'$  production with decay  $Z' \rightarrow$  invisible (left) and for dark-photon  $A'$  production with decay  $A' \rightarrow$  invisible (right)



**Figure 2**  
Recoil mass spectrum of the muon pair sample. Simulated samples (histograms) are rescaled for luminosity and corrected for efficiency. From [1].





**Figure 3**  
Feynman diagram for dark-photon  $A'$  production with  $A'$  decay into inelastic dark matter

At Belle II, dark photons are searched for in association with an energetic initial-state photon (Fig. 1, right). Since the interaction probability of dark matter with the detector is negligible, the experimental signature of such a decay will be a single mono-energetic photon, giving rise to the name „single-photon search“ for this analysis. The DESY Belle II group is leading the preparation for this intensity frontier golden-mode dark-matter search [2].

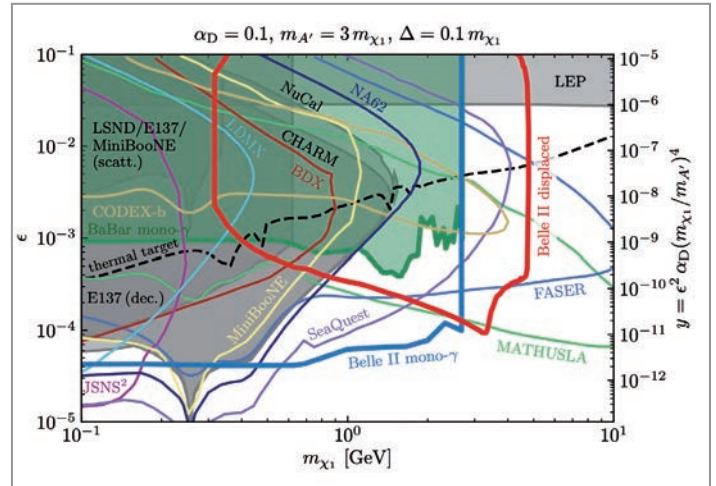
The experimentally clean environment at an electron–positron collider and the very hermetic calorimeter of the Belle II experiment promise world-leading sensitivity for GeV dark photons. SM backgrounds from  $e^+e^- \rightarrow \gamma\gamma$  and  $e^+e^- \rightarrow e^+e^-\gamma$ , where all particles but a single photon escape the detector undetected, are reduced significantly by exploiting the known initial state in  $e^+e^-$  collisions and by using the outer muon system as additional photon veto. The irreducible SM background  $e^+e^- \rightarrow \nu\nu\gamma$  is negligible at Belle II collision energies. First results are expected in 2020 with a data set of about  $100 \text{ fb}^{-1}$ .

## Search for long-lived particles

While searches like the aforementioned single-photon search are well established in the Belle I physics programme, many dark-matter models generically predict invisible and displaced signatures at Belle II, consisting of a single photon accompanied by missing energy and a displaced pair of electrons, muons or hadrons. Such events will be missed by the currently implemented search programme at Belle II because of inefficient trigger algorithms.

An example for such a final state appears in models of inelastic DM (iDM) (Fig. 3), in which a mass splitting  $\Delta$  between two dark-sector states  $\chi_1$  and  $\chi_2$  ensures that existing constraints from the cosmic microwave background and from direct detection experiments are evaded. The heavier state  $\chi_2$  can have a decay length comparable to the typical size of particle physics experiments.

The DESY Belle II group and the DESY theory group have worked together to study the sensitivity of Belle II for this model in detail [3]. Within the study, the most sensitive detector regions and selections that suppress the relevant backgrounds to a negligible level have been identified. For small mass splittings, the large lifetime of the heavier DM



**Figure 4**  
Comparison of the expected Belle II ( $50 \text{ ab}^{-1}$ ) sensitivity for inelastic dark matter with various other proposed experiments. Most experiments shown in the figure are still in early stages of development and not yet funded. From [3].

particle results in decays outside of Belle II, which makes the single-photon search sensitive to this parameter space. However, for heavy DM particles or large mass splitting, only dedicated displaced vertex triggers allow for probing a large and complementary parameter space. The DESY Belle II group contributes to implementing such trigger algorithms for future Belle II runs.

This particular DM model and long-lived particles in general have recently gained a lot of attention in the context of the CERN “Physics Beyond Colliders (PBC)” study [4]. Figure 4 shows a sensitivity comparison of various proposed PBC projects and Belle II for iDM. The rather small boost of the final-state particles, the very large expected data set and the powerful detector make Belle II competitive with dedicated lifetime frontier experiments.

### Contact:

Torben Ferber, torben.ferber@desy.de

### References:

- [1] Belle II Collaboration, Phys. Rev. Lett. 124, 141801 (2020)
- [2] Altmannshofer et al., PTEP 12 (2019), arXiv:1808.10567
- [3] Duerr et al., JHEP 02, 039 (2020), arXiv:1911.03176
- [4] <https://pbc.web.cern.ch/>

# Any light dark matter searches

Stepping closer to first data

**Converting dark matter into light:** This ambitious goal became more realistic in 2019. At DESY, different experiments in different phases aim at doing so with both galactic dark matter and dark matter generated in the sun and in the tunnel of the former HERA collider.

## The light frontier of particle physics

Open questions related to particle physics beyond the Standard Model (SM) might be solved by the existence of very lightweight, weakly interacting slim particles (WISPs, e.g. [1]). Such new constituents of nature could also well explain the dark matter in our universe and some puzzling observations concerning the evolution of stars and the propagation of light in interstellar and intergalactic space. They might even be related to the phenomenon of dark energy.

The best-known archetypal of these WISPs is the quantum chromodynamics (QCD) axion. It was predicted more than 40 years ago to explain the conservation of CP symmetry in QCD, showing up for example in the missing electric dipole moment of the neutron. The axion and other WISPs are pseudo Nambu–Goldstone bosons related to global symmetry breakings at energies many orders of magnitude above the reach of any realistic future collider experiment. Thus, a discovery of WISPs would give insight into particle physics at extremely high energies.

However, it is just this relation that complicates the detection of WISPs a lot. In general, the interaction of WISPs with SM constituents is suppressed by the high energy scale at which the WISP-related symmetry breaking takes place. Only very feeble interactions are expected. Therefore, many experiments worldwide focus on WISP–photon interactions:

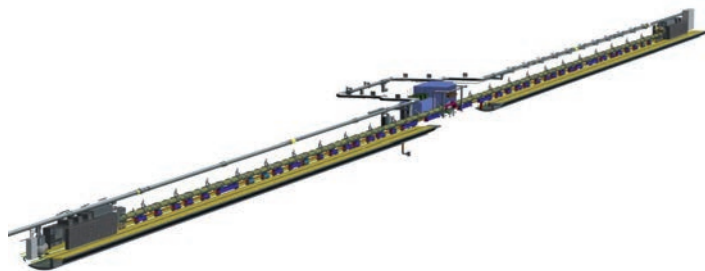


Figure 1

Model of the roughly 280 m long ALPS II installation in the HERA tunnel. Three cleanrooms for the optics installations are arranged along two strings of 12 superconducting dipole magnets each.

Technologies exist to detect extremely weak photon fluxes from X-rays to microwaves, and experiments can well be shielded from ambient “background” light. Hence, very lightweight dark-matter candidates can often best be searched for by probing their interaction with light.

## Three approaches at DESY

Across the world, an increasing community is developing and constructing new experiments to search for WISPs. DESY plays a visible role in this context by focusing on larger-scale installations, which strongly benefit from existing infrastructures at the DESY site in Hamburg. Three experimental approaches are being followed: pure laboratory experiments, the helioscope approach and a haloscope experiment.

### ALPS II

In the straight tunnel section of DESY’s former HERA collider around the HERA hall North, the “light shining through the wall” experiment ALPS II (see previous editions of this annual report) is under construction. In a first part of the experiment, axion-like particles and other WISPs might be generated by light shining into a strong magnetic dipole field. A light-tight barrier, easily crossed by any WISP, shields a second compartment, where WISPs might convert back to photons again in a strong magnetic dipole field. ALPS II will look for axion-like particles and other WISPs in a model-independent fashion by (hopefully) generating and detecting these elusive particles.

To reach a sensitivity for axion-like particles as indicated by astrophysics phenomena, a complex optical system with high-finesse, mode-matched optical resonators will be built around the magnet strings. Here, ALPS II strongly relies on technologies developed for the gravitational-wave interferometers GEO600 and LIGO.

The successful straightening of the superconducting HERA dipole magnets and the fruitful optics developments in 2018 and 2019 allowed the length of the whole experiment to be



increased from 20 to 24 magnets (Fig. 1), thereby fully using the HERA straight section. The installation work in the tunnel culminated in a “first magnet fest” in October 2019 (see cover page). Everything is on track to finalise the setup in late 2020.

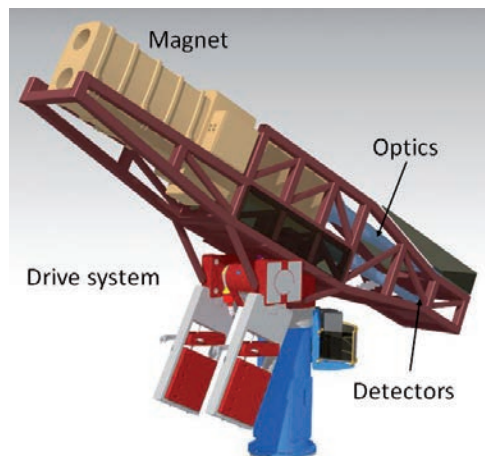
## IAXO

The International Axion Observatory (IAXO) will search for WISPs emitted by the sun. In a dedicated magnet, such particles would convert to X-ray photons. It is the only known approach to look for QCD axions up to eV masses and motivated by a rich physics field [2]. It might also allow the coupling of axions to electrons to be probed in addition to the axion–photon interaction. IAXO will combine a large movable toroidal magnet tracking the sun, grazing-incident X-ray optics similar to the ones used in satellites and extremely low-background X-ray detectors. The realisation of IAXO will also depend on the outcome of the ongoing update process of the European Strategy for Particle Physics.

BabylAXO, the prototype for IAXO, will not only allow tests of crucial technologies, but also reach unprecedented sensitivities in WISP searches. R&D activities are essentially concluded, so that BabylAXO is ready for construction (Fig. 2). The project was successfully reviewed by the DESY Physics Research Committee (PRC) in May 2019. It is hoped that international funding discussions on BabylAXO will be concluded in early summer 2020. The experiment will be located in the HERA hall South. It will reuse the drive system of the dismantled mid-sized telescope (MST) for the CTA gamma-ray observatory in Berlin, thereby fully profiting from DESY’s unique expertise and infrastructure.

## MADMAX

The Magnetized Disk and Mirror Axion eXperiment (MADMAX) targets galactic dark-matter axions [3]. These ambient WISPs would convert to very feeble microwave radiation inside a strong magnetic dipole field. The experiment cannot only demonstrate the existence of axions or other WISPs – a positive detection would directly shed light on the nature of the dark matter in our universe. Within the worldwide community, MADMAX is the only experiment that mainly focuses on cosmological scenarios in which the axion-related symmetry breaking occurs after an early inflation phase.

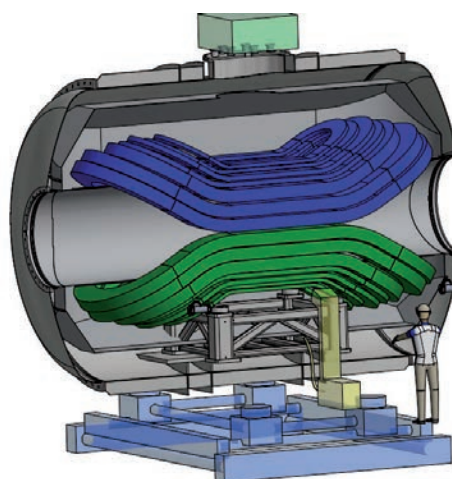


**Figure 2**  
Conceptual design of BabylAXO (summer 2019). Solar axions will be converted to X-rays inside the magnet.

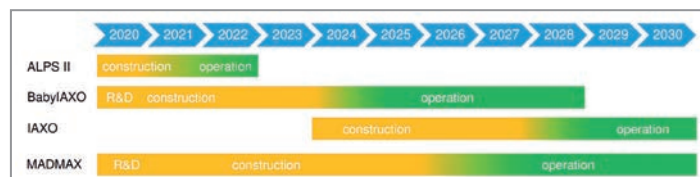
The experiment requires the development of a unique large-volume superconducting 9 T dipole magnet (Fig. 3), a new “booster” system (a high-precision microwave resonating structure of up to 80 dielectric disks of 1.25 m diameter) and new detection techniques for extremely low-flux microwave measurements. The first R&D phase was successfully concluded and evaluated in-depth by the DESY PRC in November 2019. The physics case for MADMAX was greatly acknowledged, and the R&D results were appreciated with strong encouragement for the next steps. MADMAX is planned to be installed in the iron yoke of the former H1 experiment in the HERA hall North.

## Summary

The DESY strategy to complement its experimental particle physics engagement at remote collider projects by local activities is becoming reality. Three international projects in different stages have made DESY very visible already today in the international communities and beyond. First results on WISP searches are expected from ALPS II in 2021. Figure 4 shows a rough timeline for the experimental activities.



**Figure 3**  
Conceptual design of the 200 t heavy dipole magnet for MADMAX, which will have an aperture of 1.35 m and provide a field of 8.9 T



**Figure 4**  
Timelines for experimental WISP searches at DESY. Note that BabylAXO, IAXO and MADMAX are not fully funded yet.

## Contact:

Axel Lindner, axel.lindner@desy.de

## References:

- [1] Several Problems in Particle Physics and Cosmology Solved in One SMASH, *Front. Astron. Space Sci.* 6, 55 (2019)
- [2] Physics potential of the International Axion Observatory (IAXO), *JCAP* 190, 047 (2019)
- [3] A new experimental approach to probe QCD axion dark matter in the mass range above 40  $\mu\text{eV}$ , *Eur. Phys. J. C* 79 3, 186 (2019)

# Theoretical particle physics

The DESY theory group covers a broad range of topics – from particle phenomenology and lattice gauge theory to cosmology and string theory. This scientific breadth is a unique asset of the group and of DESY, as it provides a setting for many fruitful interactions.

In particle phenomenology, results from the Large Hadron Collider (LHC) at CERN are at the centre of current activities. These include for example the application of machine learning tools in event generators (p. 56) and new results for heavy-quark form factors (p. 54). Particle phenomenology activities at DESY are strongly connected to efforts in both lattice gauge theory and cosmology. In 2019, these efforts led to an improved understanding of the strong forces in lattice simulations (p. 62). Moreover, theoretical efforts in cosmology yielded much progress in our understanding of dark and visible matter. Recent developments underline the aspect that visible and dark matter might be tightly linked and produced by very similar mechanisms (p. 60).

The last core activity of the group is string theory. The ultimate goal of these studies is to improve our understanding of the theories relevant for particle phenomenology, in particular theories at strong coupling. One promising avenue to better understand quantum field theory are self-similar quantum systems that often obey a conformal symmetry (p. 58).





ISD

AISD

$$G_3^- = \alpha' \omega + A^0$$

$$G_3^+ = \alpha \omega + \beta$$

(3,0)

$$e^{i q \int B_2}$$

$$= \sum_i M_i$$

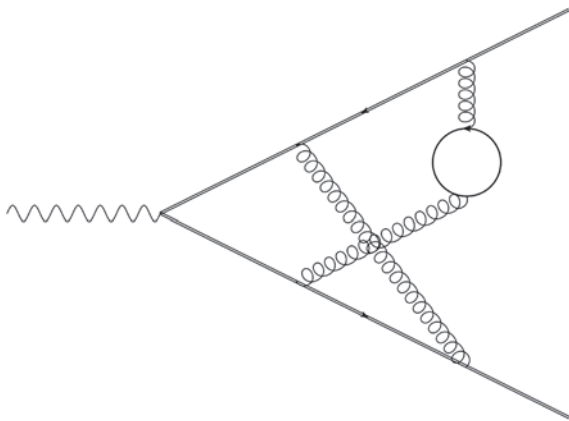
> Heavy-quark form factors by guessing	54
> Learning amplitudes for faster event generation	56
> Self-similar quantum systems	58
> Matters that matter	60
> Lattice field theory	62

# Heavy-quark form factors by guessing

An attempt to reconstruct the full result from a finite number of terms in the corresponding power

The particle physics theory group at DESY in Zeuthen has long been performing precision calculations for current and future colliders. Among the many interesting and important results obtained, we report here on a novel approach to calculate the three-loop quantum chromodynamics (QCD) corrections to the heavy-quark form factors. Our aim was to obtain the final result, i.e. the sum of many individual pieces, without having to calculate all the building blocks separately. To this end, we first calculated many terms in the corresponding power series and, in the final step, reconstructed the full analytic solution.

Together with our international collaborators, we looked at the problem of the three-loop corrections to the heavy-quark form factor, i.e. the decay amplitude of a virtual photon into a pair of massive quarks, such as a bottom- or top-quark pair. An example of typical Feynman diagrams contributing to this process is shown in Fig. 1. This process is of particular importance at current and future colliders to investigate the nature of the Higgs boson and the top quark.



**Figure 1**  
Example of a Feynman diagram contributing to the process. The double line denotes the heavy quark. The internal quark can be either massive or massless.

The conventional approach to obtain the analytic solution for problems of this kind requires the calculation of complicated integrals resulting in special functions in intermediate steps, which in many cases are much more complicated than the final result once everything has been combined together.

Following the spirit that the sum is in general simpler than its parts, we skipped the calculation of the integrals at immediate steps and focused solely on the final result.

Since expansions in a kinematic variable are much less complex than the full expressions, we started by calculating many terms of a power series expansion around a suitable point. Using techniques related to differential equations, this expansion could be obtained once the initial conditions had been provided.

From these expansions, it is possible to deduce (guess) the recurrence obeyed by the corresponding expansion coefficients. To obtain the recurrences for all the different contributions, we needed up to 8000 terms in the expansion. This was of course only possible by making extensive use of advanced computer algebra. The next step, solving the recurrence, was only partially successful, since new mathematical functions appeared that still have to be studied in more detail. In the cases where we were able to solve the recurrence, the subsequent summation of the corresponding power series was also successful and resulted in expressions containing harmonic polylogarithms and their extensions.

The following example illustrates the procedure how to recover the full solution from a finite number of terms.

We start with the sequence for  $C_i$  in  $\sum C_i y^i$

$$C_i = \left\{ \begin{array}{l} -2, 0, -\frac{1}{6}, -\frac{1}{6}, -\frac{3}{20}, -\frac{2}{15}, -\frac{5}{42}, -\frac{3}{28}, \\ -\frac{7}{72}, -\frac{4}{45}, -\frac{9}{110}, -\frac{5}{66}, -\frac{11}{156}, -\frac{6}{91}, \\ -\frac{13}{210}, -\frac{7}{120}, -\frac{15}{272}, -\frac{8}{153}, -\frac{17}{342}, \\ -\frac{9}{190}, -\frac{19}{420}, \dots \end{array} \right\}$$



Next, we guess the recurrence

$$n^2 C_n - (n-1)(n+2)C_{n+1} = 0$$

and find a solution for the recurrence

$$C_n = \frac{1-n}{n(n+1)}$$

which in this case is valid starting from  $n = 1$ .

Finally, performing the sum over  $n = \{1, \dots, \infty\}$  and adding the constant term  $C_0$  yields

$$-2 + \sum_{n=1}^{\infty} \frac{1-n}{n(n+1)} y^n = -\frac{(y-2) \log(1-y)}{y}$$

Following the approach outlined above, we were able to calculate a fully analytic solution for many parts of the problem. For the cases where we could not obtain a solution for the recurrence, we are left with expansions with at least 8000 terms. However, as the recurrence itself exists, many more terms could be calculated in short time if necessary. In the worst case, we are left with a recurrence of order 55, i.e. we need the 55 previous coefficients to calculate the next term in the expansion.

Figures 2 and 3 illustrate the convergence of the series expansions we obtained for the three-loop contributions to the electric form factor with one closed massive quark loop. Figure 2 shows the behaviour in the Euclidean region where the expansion was performed around  $x = 1$ . Note that, for  $x$  tending to zero, we encountered a logarithmic singularity. Figure 3 presents our results for the region below threshold

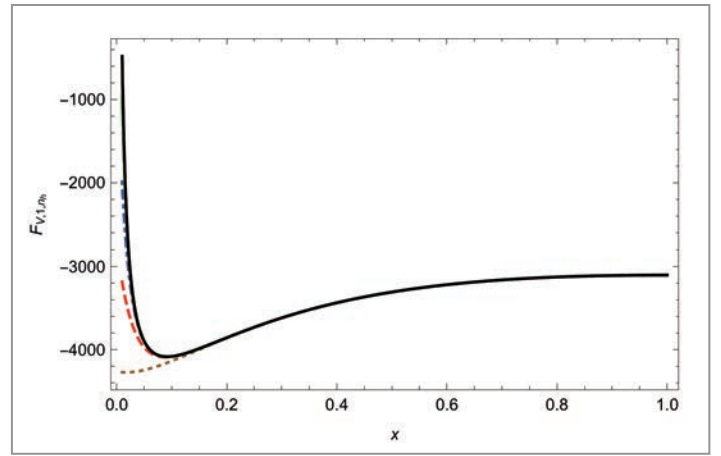


Figure 2

Result for the electric form factor in the Euclidean region for  $n = 20, 50, 100, 200, 500$  terms, shown in brown, red, blue, green and black, respectively

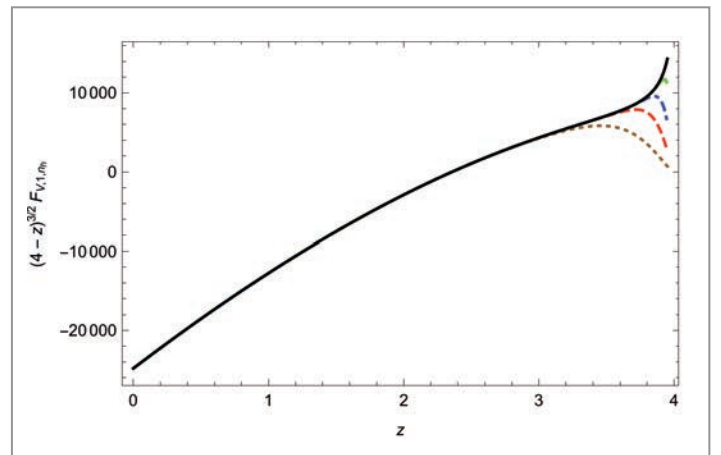


Figure 3

Result for the electric form factor in the region below threshold for  $n = 20, 50, 100, 200, 500$  terms, shown in brown, red, blue, green and black, respectively

where the expansion was performed around  $z = 0$ . We again found a singularity at  $z = 4$ , this time of the square-root type. Both figures show the corresponding approximations with 20, 50, 100, 200 and 500 terms. As can be seen from the figures, we achieved very good convergence already using only a fraction of the available data.

The recurrences that remain unsolved lead to new, more complicated mathematical objects that need to be studied in more detail. We will further investigate this problem in the future.

#### Contact:

Peter Marquard, peter.marquard@desy.de

#### References:

- [1] J. Blümlein, P. Marquard, N. Rana and C. Schneider, Nucl. Phys. B 949 114751 (2019)
- [2] J. Blümlein, P. Marquard and C. Schneider, PoS RADCOR2019 078 (2019)

# Learning amplitudes for faster event generation

Speeding up higher-order Monte Carlo event generation for LHC phenomenology using machine learning techniques

Measurements at the LHC are becoming more precise. This is perhaps especially so in cases involving electroweak particles in the final state, where uncertainties due to quantum chromodynamics (QCD) are reduced. These precise experimental measurements are useful for two related purposes: to better understand the Standard Model (SM) itself and to constrain or, hopefully, discover new physics beyond it (BSM). To do this, however, precise predictions for the SM contribution are required. While many SM processes are now known to next-to-next-to-leading-order (NNLO) accuracy, generating enough Monte Carlo events at this accuracy is very time-consuming. A new idea to solve this problem was proposed at DESY. It aims to tackle a time-consuming part of the computation by approximating the squared matrix elements using machine learning techniques and in particular gradient-boosting machines.

Thanks to big efforts in experimental and theoretical high-energy physics, the LHC has evolved from an energy frontier machine to a precision frontier machine. Such an evolution is necessary given the planned increase in integrated luminosity at fixed energy, since putative new resonances can typically be discovered as soon as they are energetically accessible, with little integrated luminosity. This was the case with the discovery of the Higgs boson in 2012 – it was discovered with only  $10 \text{ fb}^{-1}$  of data! While the LHC is certainly still capable of discovering new resonances, which could be weakly coupled or appear in regions of the phase space where the backgrounds are peaked or overwhelming, the CERN collider is becoming quite useful in precision studies where the BSM signal is non-resonant and small compared with the SM background.

Interpreting precision measurements at the LHC, however, requires precision predictions of SM processes. And while the last decade saw an accelerated increase in theoretical computations at NNLO, their use in phenomenological studies has been lagging, presumably due, in part, to the lack of fast Monte Carlo event generators at this order. Event generation at NNLO is slow because of the need to evaluate numerically expensive functions and the need for quadruple precision arithmetic in some regions of phase space, among other reasons.

A possible solution to speed up event generation is to approximate the functions of interest – the squared matrix elements, say, in an attempt to reduce the numerical cost of evaluating the exact function.

This solution is particularly amenable to machine learning techniques and especially deep neural networks (DNNs),

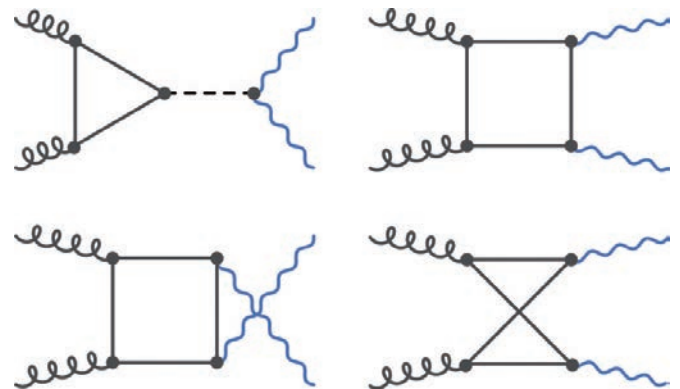


Figure 1

Feynman diagrams that contribute to Z boson pair production via gluon-gluon fusion

since there exists a proof (the universal approximation theorem) that DNNs can approximate any function arbitrarily well. In practice, however, it turns out that another technique is better suited for functions with a few variables that require accurate and fast approximation: gradient-boosting machines (GBMs). This will be our tool of choice.

As a proof of concept, we studied the process  $gg \rightarrow ZZ$ , which is loop-induced at LO (Fig. 1). This was motivated in part because it belongs to a class of processes of phenomenological interest at the LHC collectively referred to as di-boson processes. In particular,  $gg \rightarrow ZZ$  contributes to the bulk of the NNLO correction to  $pp \rightarrow ZZ$ . Furthermore, for di-boson processes, NNLO corrections are phenomenologically relevant (see for example Ref. [1]).

We found that GBMs can achieve prediction times 1000 times faster than the time required by traditional tools, while the



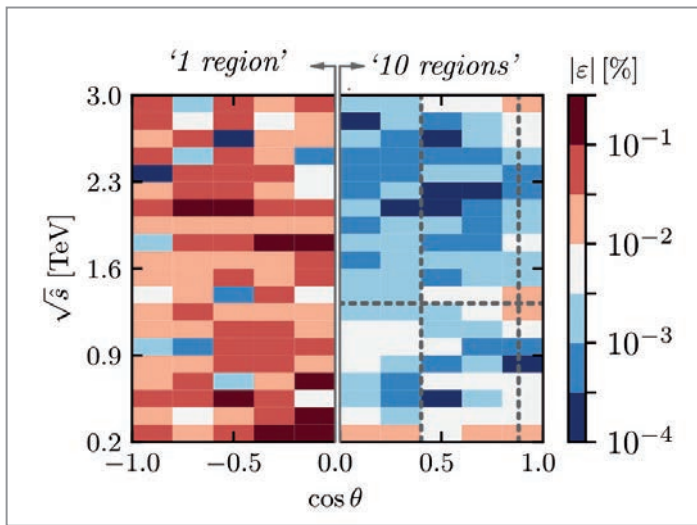
predicted values for single- and double-differential distributions had errors below 0.1%. This was achieved with training times of less than 7 min on a single CPU core and with a disk size for the trained models of a few Mb.

For unpolarised gluons, the fully differential partonic cross section only depends on two phase space coordinates, the partonic centre-of-mass energy (or, equivalently, the di-Z invariant mass  $m_{ZZ}$ ) and the polar angle of the Z boson (equivalently, the transverse momentum  $p_T$  of the Z boson). Furthermore, the polar angle distribution is symmetric under  $\cos(\theta) \rightarrow -\cos(\theta)$ .

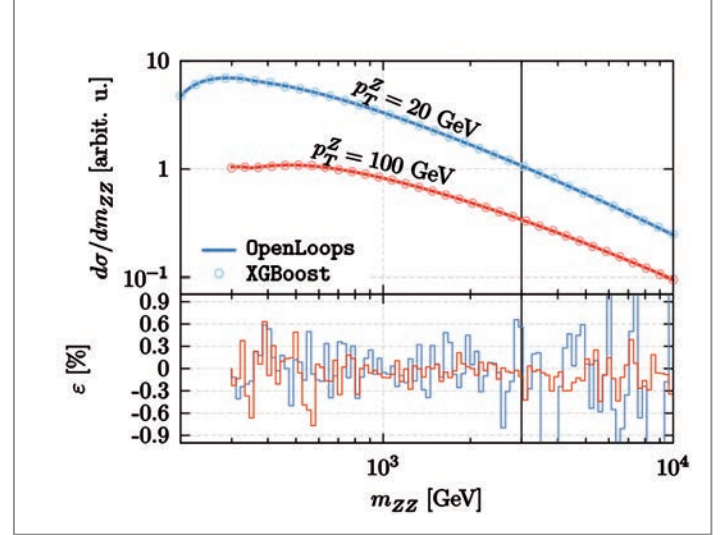
As mentioned earlier, our tool of choice was the GBM, and we used the XGBoost implementation [2]. For more details about the other algorithms we considered and the hyper-parameter tuning in XGBoost, see Ref. [3]. Once the final hyper-parameters were chosen, we compared the performance of one model trained on the entire phase space against 10 models trained on contiguous, disjoint partitions of it. These partitions are delineated by dashed grey lines in the right panel of Fig. 2. Such partitioning, which was done manually in this case, can be automated with VEGAS, for example. As can be seen from Fig. 2, the partitioning improved the relative error of the prediction by orders of magnitude. The relative error is defined as

$$\varepsilon = \frac{\langle |\mathcal{M}|^2 \rangle_{\text{OpenLoops}} - \langle |\mathcal{M}|^2 \rangle_{\text{XGBoost}}}{\langle |\mathcal{M}|^2 \rangle_{\text{OpenLoops}}}. \quad (1)$$

The exact matrix elements were evaluated and timed using OpenLoops 2 [4].



**Figure 2** Absolute value of the relative error between the approximate and exact squared matrix elements. The left panel shows the result for one model trained on the full phase space. The right panel shows the results from 10 separate models trained on contiguous, disjoint partitions.



**Figure 3** Single-differential cross section and relative error for fixed values of the transverse momentum of the Z boson. Top panel: Exact (solid curves) and approximate (open circles) differential distributions. Bottom panel: Relative error as defined in Eq. (1) for the two  $p_T$  values.

Figure 3 shows the single-differential distribution with respect to the di-Z invariant mass. The top panel presents the exact distribution obtained with OpenLoops, while the open circles indicate the results obtained with our model – partitioned only at  $m_{ZZ} = 3$  TeV and with no partitioning on  $\cos(\theta)$ . The bottom panel shows the relative error as defined in Eq. (1), in 100 log-uniform bins. The relative error is less than 1% even with such fine binning. The approximation errors are nicely distributed around zero, meaning that integrating reduces the relative error in a given bin.

In summary, the machine learning approach to approximating squared matrix elements that are time-consuming to calculate performed extremely well – specifically, with approximation errors on the order of  $10^{-3}$  and a 1000-fold increase in the prediction speed per phase space point with respect to evaluating the exact function. With this success at hand, we will continue on this path, with the ultimate goal of speeding up event generation at NNLO. In particular, a next step will be to approximate the two-loop term involving interference of virtual with Born contributions.

#### Contact:

Fady Bishara, fady.bishara@desy.de

#### References:

- [1] ATLAS Collaboration, Eur. Phys. J. C79 no.10, 884 (2019)
- [2] T. Chen, C. Guestrin, arXiv:1603.02754
- [3] F. Bishara and M. Montull, arXiv:1912.11055
- [4] F. Buccioli et al., Eur. Phys. J. C79 no.10, 866 (2019)

# Self-similar quantum systems

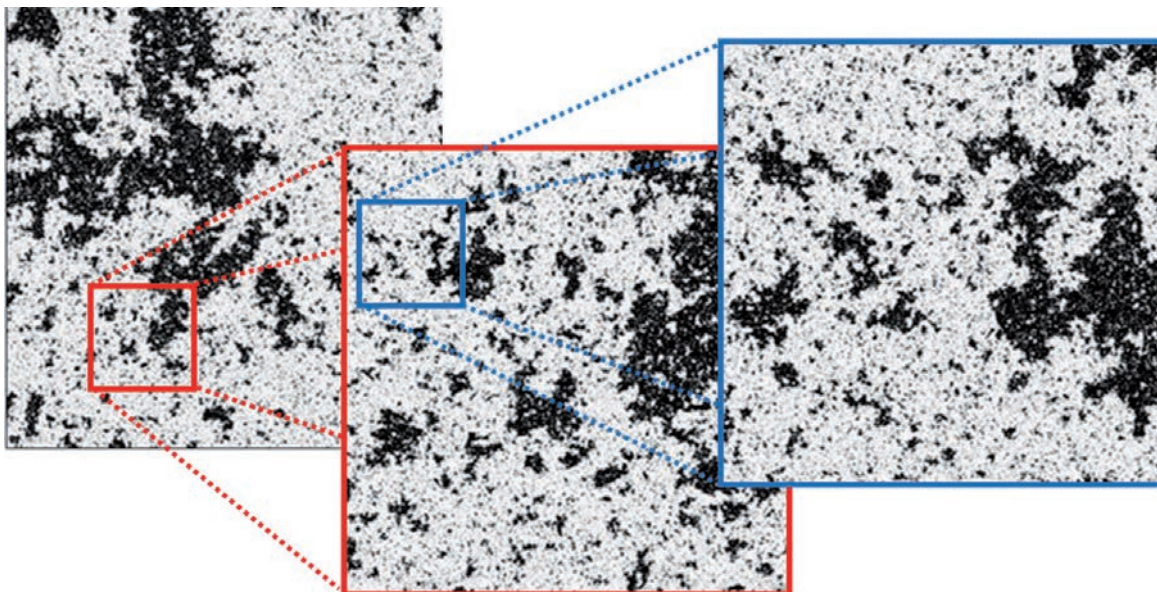
Novel analytical tools from mathematics and particle physics

Many objects in nature are self-similar: The whole object looks exactly or approximately the same as its parts. Such behaviour is not limited to the macroscopic world, but can also appear in microscopic systems that are described by the laws of quantum mechanics. So-called conformal quantum field theories provide the most relevant class of self-similar quantum systems. By combining the latest mathematical developments with methods from particle physics, theorists at DESY have advanced analytical tools for the study of conformal field theories. These are beginning to uncover new views on dynamics deep in the quantum regime.

The study of self-similar quantum systems has a long history. There exist many 1+1-dimensional conformal quantum systems that have been solved exactly, thanks to an additional enhancement of their symmetry, and they were used to describe a wide range of phenomena in quantum wires or critical spin chains. For higher spatial dimension, things become significantly more difficult. In 2+1-dimensional quantum systems, the critical Ising model and some of its close relatives are key examples that are used to measure theoretical progress, and indeed modern tools from quantum field theory have recently allowed the calculation of critical exponents with record precision [1]. In 3+1 (and higher) dimensions, most of the known examples of conformal field theories possess supersymmetry. String theory in fact

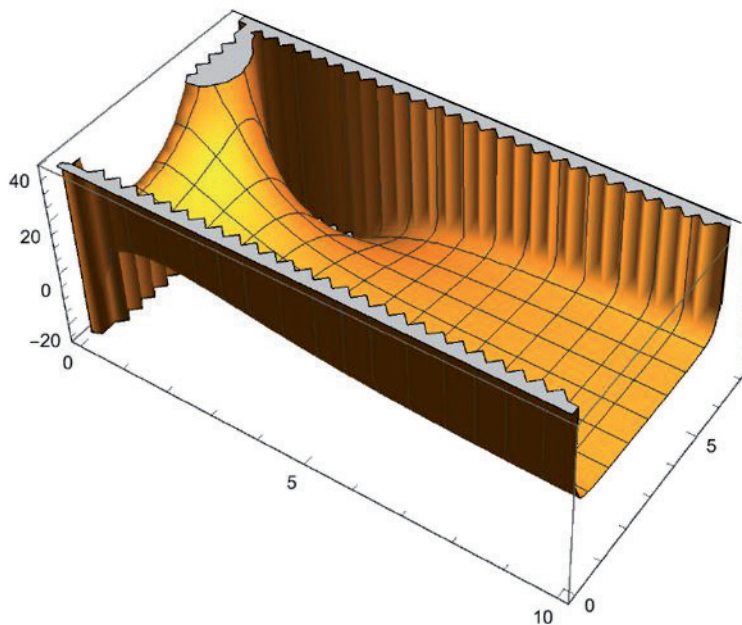
predicts the existence of a very large class of such theories, many of which are not accessible with existing techniques from perturbative quantum field theory.

The analysis of such self-similar quantum systems requires entirely new analytical tools. For systems with translational symmetry, one can employ the powerful toolbox of Fourier analysis, which mathematicians and physicists started to develop more than 200 years ago. It allows all quantities to be decomposed into basis plane waves  $\psi_k(x) = \exp(ikx)$ , which possess very special properties under translations: Under a shift of  $x$  by some constant, plane waves are just multiplied by a phase. For systems with conformal symmetry, physicists and mathematicians are striving to develop a



**Figure 1**  
Fluctuations in the critical Ising model have the same statistical properties on all scales.





**Figure 2**

Conformal Fourier analysis is based on a multidimensional exactly solvable generalisation of the one-dimensional Schrödinger problem for the Pöschl–Teller potential.

similar conformal Fourier theory that would allow the decomposition of all physical quantities into a basis of so-called conformal partial waves. Progress is significant and related to many different branches of modern mathematics and particle physics.

It has been known for almost 50 years that conformal partial waves possess certain integral representations that resemble the type of integrals particle physicists encounter when studying Feynman graph expansions, e.g. in the Standard Model. More recently, this similarity was interpreted in the context of the celebrated gauge/gravity duality, which relates conformal quantum field theories in  $d$  dimensions with certain gravitational models in  $d+1$  dimensions. Perturbative expansions in these  $d+1$ -dimensional models were pioneered by Edward Witten, and they are based on a diagrammatic expansion that is quite similar to Feynman diagrams. Conformal partial waves turn out to be determined by so-called geodesic Witten diagrams, and in this sense, they are indeed close relatives of Feynman integrals.

While this insight does not in itself make conformal partial waves any more accessible – after all, physicists are also struggling to compute Feynman integrals – it suggests that the strategies developed by particle physicists who are dealing with Feynman integrals may carry over to the study of conformal partial waves. One of these successful strategies is to characterise Feynman integrals through a set of differential equations that they satisfy and then to extract the properties of the integral from features of these differential equations. This strategy indeed carries over to (geodesic) Witten diagrams and hence to conformal blocks, as demonstrated

by Francis Dolan and Hugh Osborn a decade ago. Over the last few years, researchers at DESY and Universität Hamburg have made leading contributions to the study of such differential equations and thereby to the understanding of conformal partial waves.

In particular, they uncovered and derived [2] an intriguing relation with differential equations that have been studied by mathematicians throughout the last few decades in an attempt to extend the theory of ordinary hypergeometric functions, which were first studied systematically by Carl Friedrich Gauss more than 200 years ago. These take the form of multidimensional generalisations of the Schrödinger problem for the famous Pöschl–Teller potential, an insight that enabled many new results on conformal partial waves. Among them is the first systematic study of conformal partial waves for generic fields in superconformal quantum field theories, which is particularly relevant in the context of four-dimensional models [3]. In addition, the scientists from DESY and Universität Hamburg also advanced conformal Fourier analysis for correlation functions involving higher-dimensional defects and studied applications in particular to certain line defects on the three-dimensional critical Ising model [4].

#### Contact:

Volker Schomerus, volker.schomerus@desy.de

#### References:

- [1] S. El-Showk et al., Phys. Rev. D 86, 025022 (2012)
- [2] I. Burić, V. Schomerus and M. Isachenkov, arXiv:1910.08099 [hep-th]
- [3] I. Burić, V. Schomerus and E. Sobko, JHEP 2001, 159 (2020)
- [4] P. Liendo, Y. Linke and V. Schomerus, arXiv:1903.05222 [hep-th]

# Matters that matter

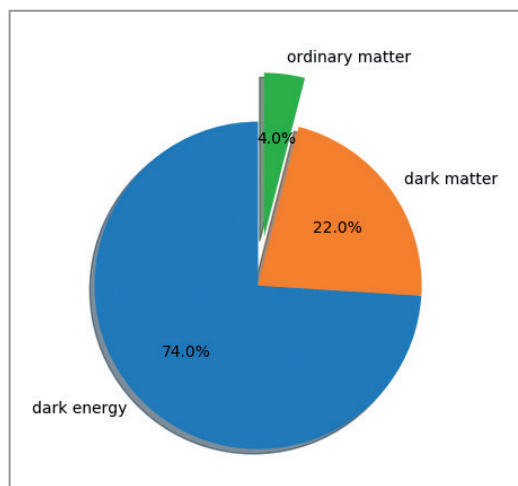
## Unravelling the origin of visible and dark matter

One of the biggest puzzles in cosmology is the origin of matter. Two kinds of matter are abundant in the universe: The first is visible matter, which forms planets and stars or fills the universe as a gas. The second is dark matter, which can so far only be traced through its gravitational pull, for example in the dynamics of galaxies or the expansion of the universe. Since these two kinds of matter have a similar abundance, it seems likely that they arise from the same mechanism. Gravitational wave observations and collider experiments can potentially shed some light on this question.

### Matter puzzles of the universe

While ordinary matter and radiation can be observed in the universe through their interactions with Standard Model particles such as photons and electrons, the existence of dark matter and dark energy can so far only be deduced through their gravitational effects. Dark matter changes the dynamics of galactic halos and also has an impact on the expansion rate of the universe. Likewise, the abundance of dark energy (or more specifically the existence of a so-called cosmological constant) can be deduced from its effect on the expansion of the universe. Hence, any phenomenon that is sensitive to the expansion of the universe will provide knowledge on the energy content of the universe.

Prime examples are the cosmic microwave background (which consists of freely travelling photons produced a few hundred thousand years after the big bang) or big bang nucleosynthesis (which predicts the abundance of light elements like helium produced minutes after the big bang).



**Figure 1**  
Cosmic pie chart depicting the energy content of the universe

Such observations ultimately lead to our current understanding of the energy content of the universe (Fig. 1).

These results immediately beg several questions: What is dark energy? What is dark matter made of? Dark energy can only be tested gravitationally through its impact on the expansion of the universe. However, dark matter could be a so-far undiscovered particle species that just interacts relatively weakly with Standard Model particles.

One prominent scenario for dark-matter generation is the WIMP paradigm, where WIMP stands for weakly interacting massive particle. The basic observation here is that a neutral particle with a mass of electroweak scale, which annihilates into Standard Model particles with a cross section of electroweak size, would roughly predict the right abundance of dark matter. Such a dark-matter candidate can be searched for in laboratory experiments, since the annihilation rate is related to the production rate of dark matter at colliders (such as the LHC) and to scattering cross sections in direct detection experiments (such as XENON). So far, all tests of WIMP dark matter have been negative, but the search for WIMPs continues, and it is still considered a very plausible dark-matter scenario.

### Asymmetric dark matter

Another striking feature of the cosmic pie chart is that the abundance of dark energy, dark matter and baryonic (ordinary) matter are quite similar and not drastically different. In the WIMP paradigm, this fact is unexplained, as dark matter and baryonic matter have completely different origins: The abundance of WIMPs hinges on the annihilation rate of the neutral dark-matter candidate, while baryonic matter must have been produced by a much more elaborate mechanism called baryogenesis.



There are several proposals how baryogenesis could have worked in the early universe, but due to the nature of baryonic matter, they all share certain features. Baryons predict antibaryons that have the same mass but opposite charges, such as protons and antiprotons. So, in order to produce an excess of baryons, baryons and antibaryons must behave differently. This is not so easy to realise in a concrete model, since interactions that allow for changing baryon numbers at will typically also make the proton unstable (the proton is stable in the Standard Model, as there is no lighter baryon it can decay into and baryon number is conserved). In a viable baryogenesis mechanism, even more symmetries of this kind have to be broken, for example charge–parity conjugation. In turn, introducing interactions that break charge–parity conjugation induces electric dipole moments in the Standard Model particles, which are experimentally tightly constrained.

One possibility to avoid this conundrum and also relate the dark-matter abundance to the abundance of visible matter is to postulate baryogenesis in the dark sector. Electric dipole moments are no issue for particles in the dark sector, and heavy neutrinos (which carry lepton number) can communicate a baryon asymmetry in the dark sector to the visible sector. The question is then how such a proposal can be tested.

### Experimental tests of the dark side

One possibility is to test properties of the baryogenesis mechanism that do not rely on particle interactions but on gravity, whose properties are universal in the dark and visible sectors. For example, the baryogenesis mechanism in the dark sector could be electroweak baryogenesis, which relies on a first-order cosmological phase transition. Such a phase transition produces gravitational waves that can be tested in future gravitational wave interferometers (Fig. 2).

Another possibility is to search for the heavy neutrinos that are essential in communicating the asymmetry from the dark sector to the visible sector. Among other things, typical signals at colliders would include exotic decays of the Higgs and Z bosons. Several experiments are under way to test the relevant parameter space.

Since most particles in the dark sector cannot decay into Standard Model particles, in many scenarios the dark sector predicts too much dark matter. This situation is avoided if there is a light particle in the dark sector (for example a dark light neutrino) that would act as a dark radiation component absorbing all the energy in the dark sector. Future probes of the cosmic microwave background will be very sensitive to such a dark radiation component.

Finally, one plausible scenario is that the dark sector mirrors the visible one. In this case, the dark matter would be the dark neutron or dark proton, depending on the details of the model. In such a setup, the ordinary photon would mix with

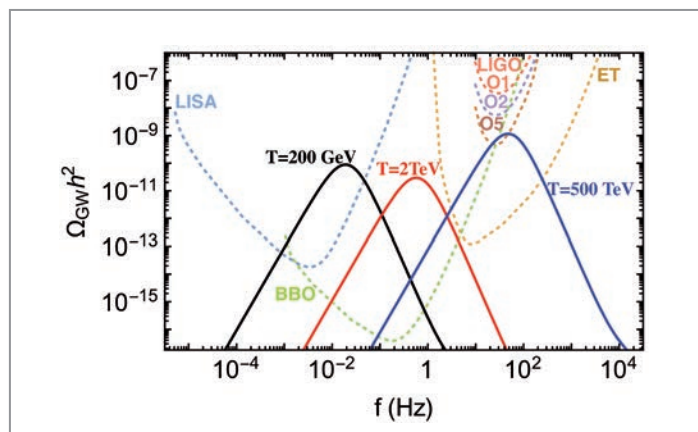


Figure 2

Exemplary gravitational wave spectra from cosmological phase transitions as well as experimental sensitivities

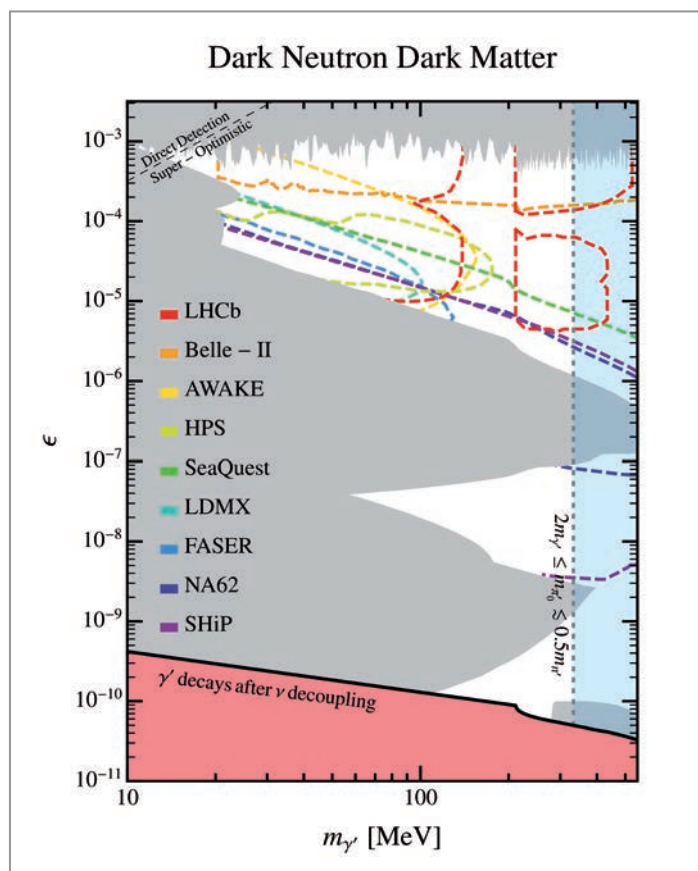


Figure 3

Prospects to test a dark photon. The two axes denote the dark-photon mass and the mixing with the visible photon.

the dark photon. Several experimental probes will constrain such a scenario in the near future (Fig. 3).

#### Contact:

Thomas Konstandin, thomas.konstandin@desy

#### References:

- [1] E. Hall, T. Konstandin, R. McGehee and H. Murayama, arXiv:1911.12342
- [2] E. Hall, T. Konstandin, R. McGehee, H. Murayama and G. Servant, arXiv:1910.08068

# Lattice field theory

## Understanding discretisation effects in lattice QCD

The Elementary Particles group at the John von Neumann Institute for Computing (NIC) at DESY in Zeuthen performs research in the area of non-perturbative quantum field theories. Here, we discuss a newly developed analytical description of discretisation effects in lattice quantum chromodynamics (QCD). Following the original idea of Kurt Symanzik of analysing discretisation effects, a perturbative calculation is performed to quantify the corrections to the leading-order effects in the lattice spacing. Understanding these corrections improves the control over the continuum limit of lattice QCD.

### Introduction

A particular focus of the activities of the NIC group lies in the quantitative understanding of the strong interaction between quarks and gluons, described theoretically by QCD. In order to evaluate QCD, it is formulated on a four-dimensional space–time grid, which then provides a full non-perturbative regularisation of the theory. In addition, by moving to Euclidean time and using Richard Feynman’s path integral formulation, numerical methods of statistical mechanics can be employed, such as Monte Carlo simulations.

Using such lattice simulations, many physical quantities can be computed, which then serve as input for on-going and planned experiments all over the world. The group is very active in developing improved simulation algorithms, designing new conceptual ideas and applying alternative approaches, such as tensor networks, to achieve more and more precise results and perform simulations in regions of parameter space that are not accessible to standard methods.

In collaboration with a number of international partners, the NIC group has worked on many topics, among them the review of existing and the development of new methods to compute the strong coupling constant; the exploration of lattice calculations of parton distribution functions; improved methods to reduce statistical errors in the Monte Carlo

simulations used; applications of tensor network methods for topological effects and real-time evolutions of a quantum field theory; calculations of hadronic contributions to the muon anomalous magnetic moment; the non-perturbative investigation of conformal field theories; and first attempts to perform quantum simulations of simple field theories. In the following, we will describe in more detail one activity of the group, carried out together with the particle theory group at DESY in Zeuthen, which aims to analytically describe discretisation effects in lattice QCD. This is important in order to control the continuum limit.

### The continuum limit: scaling violations and the Symanzik effective field theory

Our Monte Carlo or tensor network methods are based on a discretisation of space–time as a first, essential step. In the standard Monte Carlo method, this is the discretisation of three-dimensional space and of time in one common lattice with one and the same spacing  $a$  along all four axes. The graph on the left side of Fig. 1 shows a two-dimensional plane. The force carriers of QCD, the gluons, are associated to the connections of the lattice points. They are represented by the black springs. The quarks are located at the lattice points (green balls). As far as we know, nature has a continuous space–time. We therefore have to understand how our results depend on the spacing  $a$  and how the limit  $a \rightarrow 0$  is reached.



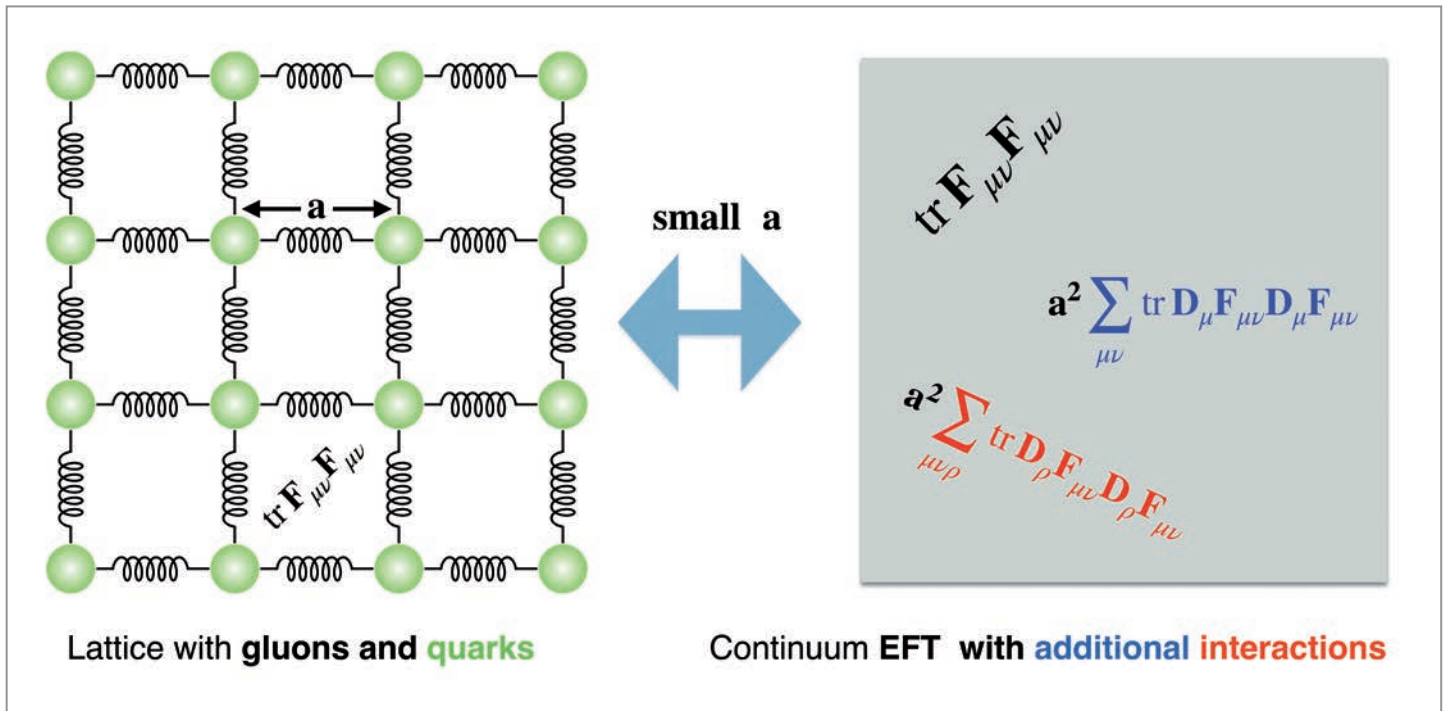


Figure 1  
Sketch of the equivalence of lattice simulations with continuum dynamics

The basic theory was postulated by Kurt Symanzik during his work in the early 1980s. Accordingly, the theory is known as Symanzik effective field theory or SymEFT. It starts from a consideration of the discretisation of a classical field theory, as it is for example relevant for the prediction of particle trajectories in accelerators. In a sufficiently symmetric discretisation, the corrections to the continuum are proportional to the square of the spacing  $a$ . The same holds true for the classical field theory, chromodynamics, which describes classical quarks and gluons.

However, the quantum nature of the theory of strong interactions is absolutely essential. We thus only speak of QCD. The behaviour at small grid spacing is complicated by the non-linear nature of QCD. However, Symanzik suggested that it can be understood using a continuum quantum field theory with additional interactions multiplied by two powers of the lattice spacing and additional couplings. The couplings originating from the gluons are the coloured terms in the EFT part of the graph (Fig. 1, right). Symanzik predicted that the divergences of the quantum field theory lead to modifications of the power behaviour caused by effects varying logarithmically in the spacing. For the first time, many years after Symanzik's original work, we have performed a systematic analysis of these effects, and we now know the power of the logarithms. We started with a few simplified versions of QCD, but the behaviour of the effects for full QCD will also soon be known.

The key to these computations is the so-called anomalous dimension matrix of the interaction terms. Since we are interested in small spacings, perturbation theory in the coupling can be applied. This is analogous to scaling violations in deep-inelastic scattering or in the QCD structure functions, which can be computed at high energies or equivalently small distances.

The outcome of the analysis is very reassuring: The logarithmic effects are small. They actually accelerate the convergence to the continuum somewhat. The result can be used to reduce the systematic uncertainty in the analysis of future Monte Carlo computations.

#### Contact:

Karl Jansen, karl.jansen@desy  
 Peter Marquard, peter.marquard@desy  
 Stefan Schäfer, stefan.schaefer@desy  
 Hubert Simma, hubert.simma@desy  
 Rainer Sommer, rainer.sommer@desy

#### References:

- [1] K. Symanzik, Nucl. Phys. B226, 187-227 (1983)
- [2] N. Husung, P. Marquard and R. Sommer, arXiv:1912.08498
- [3] S. Aoki et al., Eur. Phys. J C80, no.2, 113 (2020)
- [4] M.C. Banuls et al., arXiv:1911.00003
- [5] C. Alexandrou et al., Phys. Rev. D 99, 114504 (2019)



# Projects and infrastructure

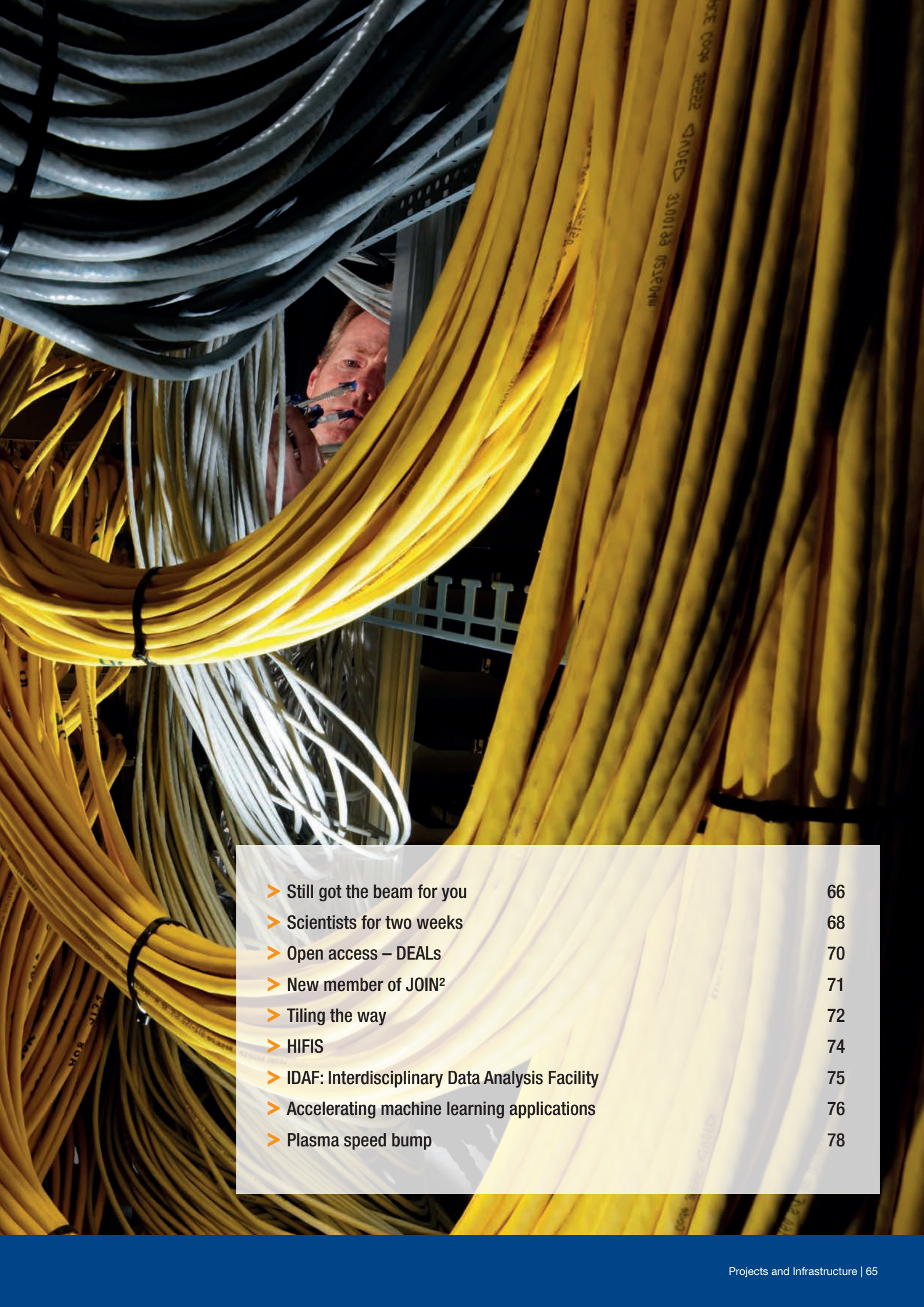
The experimental and theoretical research activities at DESY would not be possible without the contributions and support from numerous groups and people. One important service offered by DESY is its Test Beam Facility at the DESY II synchrotron. Scientists from all over the world are using the facility to subject newly developed detector components, e.g. for the International Linear Collider (ILC) or the LHC upgrades, to tests with electron or positron beams (p. 66). The group also successfully hosted the 2019 Beamline for Schools competition (p. 68).

Just as essential are the DESY electronics groups, which design and manufacture important components for particle physics detectors. One activity here is the calorimeter of the CMS experiment, which will be upgraded for the high-luminosity phase of the LHC (p. 72). Meanwhile, the FLASHForward project (p. 78) aims at developing a complete new accelerator technology: plasma wakefield acceleration.

Computing too is a crucial ingredient. The DESY IT group is constantly striving to improve its services for all users and needs, for example uniting the capabilities of the Helmholtz community (p. 74). These efforts led to the plan to unify access for all users and combine the provided services in an interdisciplinary scientific computing centre (p. 75). Machine learning is also a hot topic in the DESY IT group (p. 76).

Meanwhile, the DESY library group is transforming the publishing landscape towards open access (p. 70) and collaborating with other institutes to unify publication processes (p. 71).





➤ Still got the beam for you	66
➤ Scientists for two weeks	68
➤ Open access – DEALs	70
➤ New member of JOIN <sup>2</sup>	71
➤ Tiling the way	72
➤ HIFIS	74
➤ IDAF: Interdisciplinary Data Analysis Facility	75
➤ Accelerating machine learning applications	76
➤ Plasma speed bump	78



# Still got the beam for you

DESY II Test Beam Facility looks back at record year 2019

DESY operates the DESY II Test Beam Facility for R&D projects from the global detector community. In 2019, the facility started running again in February 2019 and – excluding a short, one-week summer shutdown – delivered beam reliably to a record number of 702 users until Christmas 2019. The main reason for the extensive use of the facility in 2019 was the beginning of a two-year shutdown of the CERN accelerator complex. The facility also hosted the 2019 edition of the Beamline for Schools competition in close collaboration with CERN. The world-class infrastructures at DESY, such as the EUDET-type pixel beam telescopes or the large-bore magnets, also continued to be in strong demand. At the same time, planning for future upgrades intensified, with further significant upgrades and extensions to be rolled out to users in 2020.

## The DESY II Test Beam Facility

The DESY II Test Beam Facility uses the DESY II synchrotron for beam generation by means of micrometre-thin carbon fibre targets placed in the primary electron beam. It offers three beamlines located in Hall 2 on the DESY campus in Hamburg. The beamlines can be individually controlled by the user groups and provide electron or positron beams in the energy range from 1 to 6 GeV. The ease of use and excellent infrastructure make it a very popular facility within the global user community. The test beam team constantly adds improvements to the beamlines and strives to keep the facility a world-class venue for detector R&D.

Two major contributions from the EU-funded AIDA-2020 project were successfully concluded in 2019: the development of a large-area silicon strip telescope and the design

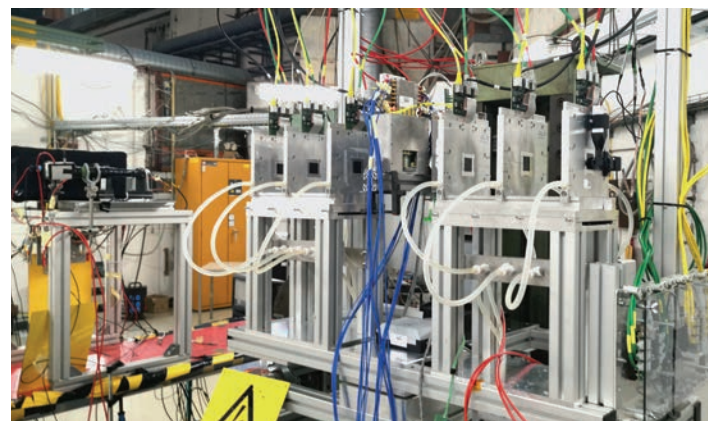


Figure 1

The TOTEM setup installed at the DESY II Test Beam Facility, with the diamond sensors inside the EUDET-type beam telescope on the right and the quartic bars and the nT2 plastic scintillators on the left

and test of the EUDAQ2 common data acquisition (DAQ) framework, which allows different detectors to run using a joint DAQ framework.

## Highlights from 2019

During the winter shutdown 2018/19, the test beam team was busy as usual with general maintenance and preparations to get the facility ready again for the 2019 run. The most important aspect was the replacement of the interlock system with a modern state-of-the-art system, which is also used at PETRA III and the European XFEL. The entire dismantling and the installation of the new system happened in a period of less than five weeks and were completed on time and budget. Since then, the system has been operating smoothly, and it proved to be a clear improvement particularly in terms of user friendliness. As the CERN test beams entered a two-year shutdown, a third EUDET-type beam telescope, AZALEA, was moved from CERN to DESY and installed in Beamline 24 to meet the expected demand for slots with a telescope available.

In 2019, the test beam facility was operated for 40 weeks, resulting in 120 user weeks over all beamlines, 96% of which were booked. The telescopes were again in high demand, with 74% of the groups requesting their use. Among the user communities, the LHC groups dominated again with 44% of requests, driven in particular by the high-luminosity (HL-LHC) detector upgrades. There were also many first-time users from experiments such as T2K, SHiP, CEPC or TOTEM. In 2019, a total of 702 users from 31 countries used the facility, setting an all-time record. Again, almost 40% of the users came to DESY for the first time. This underlines the key role of the facility as a training ground for the next generation of



detector experts: Around half of the users are students and postdocs. In addition, the educational use of the beamlines is now well established. Three summer students conducted experiments at the test beam with great success, and the facility hosted the 2019 edition of the Beamline for Schools (BL4S) competition in close collaboration with CERN.

### TOTEM

Detectors for both the precision proton spectrometer (PPS) of the CMS experiment and the new T2 (nT2) telescope of the TOTEM experiment at the LHC were tested with electrons with energies of 4 to 6 GeV. The PPS single-crystal diamond timing sensors had been operated in the PPS roman pot stations in the LHC from 2016 to 2018. To determine the precise location and extent of the radiation damage on the diamond sensors, the sensors' performance over the whole fiducial area was mapped using the AZALEA telescope. In addition, the prototype plastic scintillators for the nT2 telescope and the quartic bars were tested (Fig. 1).

### ATLAS HGTD

The expected increase of the particle flux at the HL-LHC will significantly degrade the ATLAS detector performance, especially in the forward detector region. The high-granularity timing detector (HGTD) is a new silicon-based detector expected to provide picosecond timing information in order to reduce the detrimental effect of pile-up and measure the luminosity. An extensive R&D programme is ongoing to determine if thin low-gain avalanche detector (LGAD) sensors provide the required timing resolution in harsh radiation environments.

Four test beam periods were conducted at DESY, where the performance of LGADs at different irradiation levels up to  $3 \times 10^{15} n_{eq}/cm^2$  was assessed (Fig. 2). Non-irradiated modules consisting of the sensor and a readout chip (ALTIROC) were studied as well. These tests were essential input for the technical design report (TDR) of the ATLAS HGTD. Preliminary results already demonstrated that parameters such as the collected charge, the time resolution and the efficiency were close to the requirements. Further test beam periods at DESY are scheduled in 2020 to qualify the new LGAD productions from different vendors and assess the performance of the first prototypes of a full-size assembly of sensor and application-specific integrated circuit (ASIC).

### SHIP

In CERN's Physics Beyond Colliders initiative, the proposed Search for Hidden Particles (SHiP) experiment is being discussed as a flagship project, which will allow searches for feebly interacting, long-lived, neutral particles in the GeV mass range. SHiP would also provide promising sensitivities to search for light dark-matter particles below a few hundred MeV. SHiP is to be hosted in a new beam dump facility at the CERN SPS, and several German groups are playing a leading role in various subdetector projects. A TDR is anticipated for 2020, and preparatory work has already started. In 2019, for example, performance tests of various subdetector prototypes were carried out at the DESY test beam: the

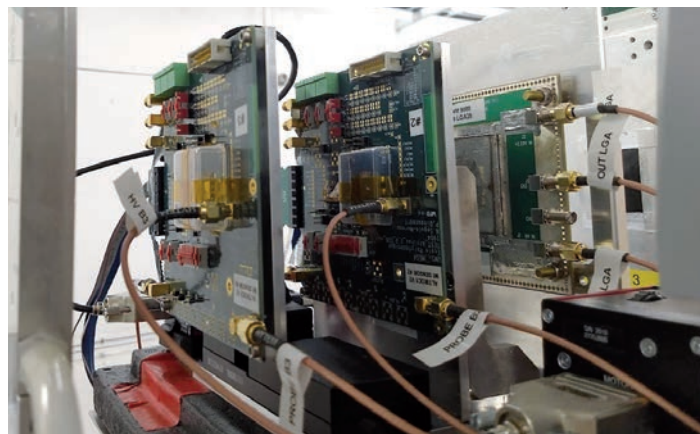


Figure 2

Two sensor-ASIC modules and a reference LGAD module installed between the two arms of the DURANTA beam telescope

electromagnetic split calorimeter, which will be used to reconstruct the mass of axion-like particles decaying into highly energetic photons; the liquid-scintillator-based surround background tagger, which will surround the 50 m long decay volume (Fig. 3); and the scattering and neutrino detector, which will be based on an emulsion scintillating-fibre tracker.

## Outlook for 2020 and beyond

The Christmas shutdown 2019/20 was again a busy time for the facility, in which e.g. the power distribution substations were replaced to meet the latest safety standards. With the shutdown of CERN also in 2020, the test beam time for 2020 at DESY is already fully booked. Starting in 2020, DESY will host the EDIT school, one of the most renowned schools for detectors and instrumentation, and the test beam will be a key asset. The BL4S competition will be back at DESY in 2020, and after a year hiatus, there will again be a teacher education programme, run jointly with the DESY school lab.

## Summary

2019 has been a record year for the DESY II Test Beam Facility, and we are looking forward to a busy year 2020. The facility is continuously being upgraded and improved, and 2020 will see several milestones completed to make it an even better facility for the users. The success of the DESY II Test Beam Facility would not have been possible without the support from many individuals and groups from the DESY particle physics and accelerator divisions. We would like to take this opportunity to thank everybody involved.

### Contact:

testbeam-coor@desy.de  
Ralf Diener, Norbert Meyners, Marcel Stanitzki

### References:

<http://testbeam.desy.de>

# Scientists for two weeks

CERN's Beamline for Schools competition premieres at DESY

In October 2019, 14 high-school students from the USA and the Netherlands swapped their classrooms for a beamline at the DESY II Test Beam Facility. Their new day-to-day routine covered silicon pixel detectors instead of textbooks, beam shutters instead of school bells and data analyses instead of homework. This was made possible by CERN's Beamline for Schools competition, which DESY hosted for the first time in 2019. The two winning teams had proposed their own particle physics experiments and herein prevailed against 176 further participating teams from all around the globe.

## Science competition

In the Beamline for Schools (BL4S) competition, teams of high-school students are asked to phrase their own research questions and design fixed-target experiments to investigate them. The constraints: The experiment has to be devised in such a way that it can be performed at a test beam facility within a bit more than one week of beam time, and it should make use of the detectors and equipment available to the project. The competition is open worldwide and has received contributions by teams from 84 countries over the past six years. In 2019 alone, 178 experiment proposals were handed in, including first-time participations from Fiji, La Réunion and Sudan. The first prize for two winning teams per year is a two-week visit to CERN or, in 2019 and 2020, to DESY to conduct their own proposed experiments guided by scientists.

The competition has been managed by CERN since 2014, where it started as a highlight of CERN's 60th anniversary. Until 2018, the experiments were performed at the PS test beams at CERN. Due to the long shutdown of the CERN accelerator complex, the competition had to evolve: DESY committed to host the winning teams and experiments in 2019 and 2020, with great interest to continue this collaboration in the future.

## Winners of BL4S 2019

Choose two out of 178? A tough decision to make! That's why it took a team of more than 60 experienced scientists – all volunteers from high-energy physics institutes – two months to find the best proposals. As a result, 30 teams were shortlisted for exceptional written proposals and videos and won BL4S T-shirts and a CosmicPi detector for their school. From the shortlist, two teams excelled and won a trip to DESY: the Particle Peers team from Praedinius Gymnasium in Groningen, the Netherlands, and the team DESY Chain from West High School in Salt Lake City, Utah, USA.

## The experiments

Both teams proposed experiments that examined the difference in the behaviour of electrons compared to their anti-particles, the positrons, by looking at different aspects of their interaction with matter.

The Particle Peers designed an experiment to investigate electromagnetic particle showers: an experimental setup resembling a highly granular sampling calorimeter, consisting of the individual silicon pixel detectors of a DESY-based beam telescope interleaved with high-density absorber materials such as tungsten or copper. This compact though heavy setup was designed to give insight into the shape and development of particle showers, enabling the budding scientists to spot a potential difference when using electrons or positrons as initial particles.

The team DESY Chain proposed to correlate the light yield of various scintillating materials with the amount of energy a



Figure 1

Winners of the Beamline for Schools competition 2019 at DESY





**Figure 2**  
Students working on their experimental setup

particle loses when traversing these materials. To this end, the amount of photons created in different scintillators was detected using a photomultiplier tube, while the energies of individual particles were determined by measuring the deflection angle caused by a 1 T magnetic field.

Both experimental setups were prepared by scientists from DESY and CERN, so that the students could concentrate on their research questions and on the operation and analysis of their experiments.

## Everyday life at DESY

The winners were high-school students aged between 16 and 18. For two weeks, they had to adapt their everyday lives to match the ones of experimental particle physicists. A typical day of test beam time included a morning meeting (What is the status of the experiments and the data analysis? What challenges did we encounter? Does the accelerator work reliably? What are the next steps?) and operation of the experiment in shifts. In parallel to data taking, data quality monitoring was performed, as were the first steps of data analysis. As befits scientists, safety briefings and the presentation of preliminary results were also part of the agenda.

## The next steps

To make the impact of BL4S more sustainable, the support scientists stay in touch with the winners of the competition after they have left the institute to guide them through the analysis of the data they acquired. Both winning teams of BL4S 2019 continued to evaluate the acquired data.

In January 2020, the Particle Peers took their next step towards a scientific career by presenting their preliminary results at the 8th Beam Telescopes and Test Beams Workshop in Tbilisi, Georgia. At the workshop, the students



mingled with 80 scientists from “their” research field, received advice and support for their data analysis and got to know new tools that would help them to gain a better understanding of their data. The team’s declared goal is “to start university with a publication in a journal for experimental physics”. In this, they aim to follow the example of three teams from previous BL4S editions, who published their results in international journals.

## BL4S 2020

The BL4S team is expecting a large number of proposals for the next round of the competition in 2020, which will again be hosted at the DESY II Test Beam Facility. The deadline for the submission of proposals is 31 March 2020, with the winners to be announced in June.

## Acknowledgements

BL4S is an education and outreach project funded by the CERN & Society Foundation and supported by individual donors, foundations and companies. In addition, BL4S at DESY is supported by a large number of local groups. We would like to take this opportunity to thank the volunteers, colleagues and groups involved for their invaluable support.

### Contact:

Paul Schütze, paul.schuetze@desy.de  
 Marcel Stanitzki, marcel.stanitzki@desy.de  
 Barbara Warmbein, barbara.warmbein@desy.de

### Reference:

<https://beamlineforschools.cern>

### Documentary Beamline for Schools 2019:

<https://videos.cern.ch/record/2710166>

# Open access – DEALs

## Transformation of the publishing landscape

In accordance with the 2003 Berlin Declaration on Open Access to Knowledge in the Sciences and Humanities, several initiatives are trying to transform the publishing landscape towards open access. In parallel, an increasing number of funding organisations demand open access as part of open science. Combining all efforts, DESY was able to achieve a 100% open-access rate for journal publications from 2019 – 407 papers in total – in the area “Fundamental Particles and Forces”.

In 2016, the Assembly of Members of the Helmholtz Association adopted a policy stating that all publications from member institutes must be open access from 2025 on. This challenge is being addressed in different ways:

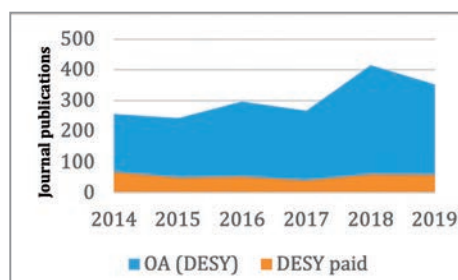
### Golden Road

Papers are made open access by publishing in an original open-access journal. To ensure maximum possible reusability, a CC-BY licence is often granted. The international Sponsoring Consortium for Open Access Publishing in Particle Physics (SCOAP<sup>3</sup>), for which DESY is one of the German national contact points, transformed four leading high-energy physics (HEP) and astroparticle physics journals into such open-access journals. Together with seven other journals, in which only subject-related articles are made open access, the consortium covers about 87% of all SCOAP<sup>3</sup> HEP publications. The average price paid by the consortium for every published article is currently around 1100 €, and the individual fee for all members is calculated by fractional author counting and averaging over previous years (Fig. 1).

Outside of SCOAP<sup>3</sup>, the article processing charge (APC) for publications in original open-access journals is paid centrally by the DESY library, when eligible.

### Green Road

In many cases, the publisher allows authors to make their (journal) publications available to the public without charge, sometimes with embargo periods. In addition, the German law for secondary publication applies. The DESY Publication



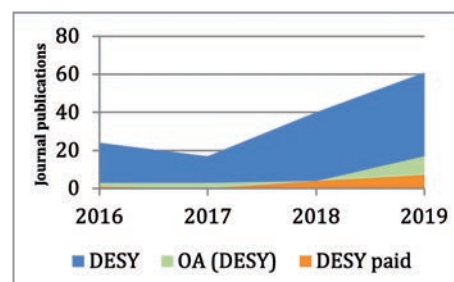
**Figure 1**  
SCOAP<sup>3</sup> publications with at least one DESY author. OA: open access. (Source: INSPIRE)

Database (PubDB) is the recommended way for DESY authors to exercise these rights.

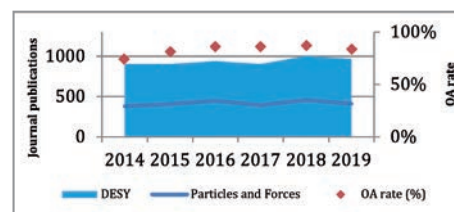
### Hybrid models

In 2019, the national DEAL consortium signed the first contract with Wiley, which allows read access to the complete journal portfolio of this publisher and open-access publishing for submitting corresponding authors of participating institutions (Fig. 2). For each article published under this agreement, Wiley is paid a publish and read (PAR) fee of 2750 €. For publications in Wiley’s original open-access journals, a 20% discount on APCs applies.

Using all available options, DESY was able to achieve an open-access rate for journal publications of over 80% (Fig. 3). It is remarkable that, as of January 2020, all 407 papers published in 2019 in the area “Fundamental Particles and Forces” were available in open access.



**Figure 2**  
Wiley publications with at least one DESY author (Source: PubDB)



**Figure 3**  
DESY publications (Source: PubDB)

### Contact:

Martin Köhler, martin.koehler@desy.de



# New member of JOIN<sup>2</sup>

## Welcome JINR

The Joint Institute for Nuclear Research (JINR) in Dubna, Russia, is a long-standing partner of DESY. In the past, JINR participated in many collaborative experiments including HERMES, HERA-B and H1 at DESY's former HERA collider. In 2019, a new cooperation agreement between DESY and JINR with two key aspects was signed. The first aspect focuses on library and documentation activities in the framework of the JOIN<sup>2</sup> project, an INVENIO-based repository used as central publication system at DESY and its project partners. The second aspect centres on combined efforts on dCache-related computing activities.

In 2005, Forschungszentrum Jülich (FZJ) and DESY teamed up to reuse and jointly improve the custom-built publication database developed and used by FZJ. In 2009, it became obvious that this system, although successfully used by both partners, needed substantial enhancements. After a careful and thorough analysis, both partners decided to go for the open-source system INVENIO built by CERN.

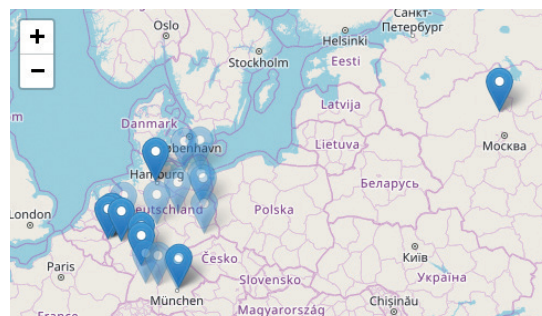
From the very beginning, Helmholtzzentrum für Schwerionenforschung (GSI) showed interest in the project and joined right before its implementation, as did RWTH Aachen University Library (UB RWTH). DESY and GSI also planned to migrate their library systems to INVENIO and, ideally, run them as an integrated system similar to CDS at CERN. In 2012, a first major milestone was reached: At FZJ, the JuSER system went into production. By 2013, all other partners had running instances as well, and Heinz Meier-Leibnitz Zentrum (MLZ) in Garching joined as a new partner. Their system iMPULSE went online in 2014. During this time, the German Cancer Research Centre (DFKZ) joined the project, while the German Centre for Neurodegenerative Diseases (DZNE) already showed first interest as well.

First contact with JINR dates back to the INVENIO user group workshop at FZJ in 2013. JINR is an international intergovernmental organisation with currently 18 member states. The institute carries out experimental and theoretical research in the areas of nuclear physics and condensed-matter physics. Already in the 1990s, DESY became the main partner of JINR among German national scientific centres in terms of the number of cooperation projects.

In 2013, JINR had already been using INVENIO on their document server (JDS, [jds.jinr.ru](http://jds.jinr.ru)) – an open-access institutional repository of articles, preprints and other material intended for information support of scientific research at the institute – for more than four years. There was a mutual interest to reuse the JOIN<sup>2</sup> system in JDS, and after some trials of the functionality of JOIN<sup>2</sup>, JINR decided to become a partner of the project in 2017.



**Figure 1**  
The JDS team at JINR (from left): R. Semenov, T. Zaikina, I. Filozova and G. Shestakova



**Figure 2**  
JOIN<sup>2</sup> partner institutions

Eventually, in March 2019, a memorandum of understanding between JINR and DESY as the representative of JOIN<sup>2</sup> was signed in order to enable JINR to develop and improve the efficiency of the JDS system. The JOIN<sup>2</sup> project will benefit from the experience and expertise of JINR to adapt and further improve the JOIN<sup>2</sup> additions to INVENIO (Fig. 1).

Today, JOIN<sup>2</sup> repositories serve more than 20 000 staff members and more than 5000 local visitors annually on campus at the participating institutes (Fig. 2). They provide more than 300 000 records as well as nearly 90 000 high-quality authority records freely on the Internet. This makes the JOIN<sup>2</sup> project one of the larger INVENIO users worldwide. The project is open for new partners who want to join the collaboration repository infrastructure.

### Contact:

Martin Köhler, [martin.koehler@desy.de](mailto:martin.koehler@desy.de)

# Tiling the way

## New SiPM-based detector modules for the CMS calorimeter upgrade

The CMS calorimeter will be upgraded for the high-luminosity phase of the LHC (HL-LHC). The concept for the highly granular calorimeter end-caps includes detector modules based on scintillating tiles that are read out by silicon photomultipliers (SiPMs) – a technology developed at DESY and originally targeted at an electron–positron detector. In addition to having to meet the required high integration level, the new detector modules will be operated in the LHC radiation environment and at  $-30^{\circ}\text{C}$ . In close cooperation, three DESY groups are developing an adequate detector module and production concept. For the assembly steps – including the automated tile wrapping, the electronics board design as well as the component and tile assembly – the foreseen number of 4000 detector modules for the CMS end-caps has to be taken into account.

### Introduction

DESY has pioneered the development of highly granular calorimeters based on scintillating tiles with SiPM readout. The fine three-dimensional segmentation provides detailed images of particle interactions (showers) in the calorimeter, which are used in particle flow reconstruction algorithms to optimise the energy resolution for jets in collision events.

It was soon realised that high granularity is also key for the efficient suppression of pile-up – i.e. particles from abundant but uninteresting collisions within the same beam crossing – which represents a major challenge for the HL-LHC. The CMS collaboration therefore adopted the SiPM-on-tile technology for the end-cap calorimeter upgrade.

### Electronics setup of detector modules

The very front-end detector modules of the CMS outer calorimeter end-caps [1], the tile boards, have a versatile design. In the CMS barrels, 36 tile boards will be placed next to each other (Fig. 1), following the circular structure of the end-caps around the beampipe. In the radial direction perpendicular to the beampipe, up to five tile boards will also be placed next to each other, resulting in at least five different board sizes from  $15 \times 21 \text{ cm}^2$  to  $42 \times 45 \text{ cm}^2$ . Along with the tile boards, the size of the scintillating tiles also varies every two rows in radial direction, ranging from  $2.3 \times 2.3 \text{ cm}^2$  to  $5.5 \times 5.5 \text{ cm}^2$ .

A typical tile board contains 64 scintillating tiles and SiPMs that are read out by an application-specific, mixed analogue and digital readout ASIC, called HGCROC [2]. The tile boards combine sensitive analogue electronics for signal charges of around 400 fC with fast digital electronics, including the data

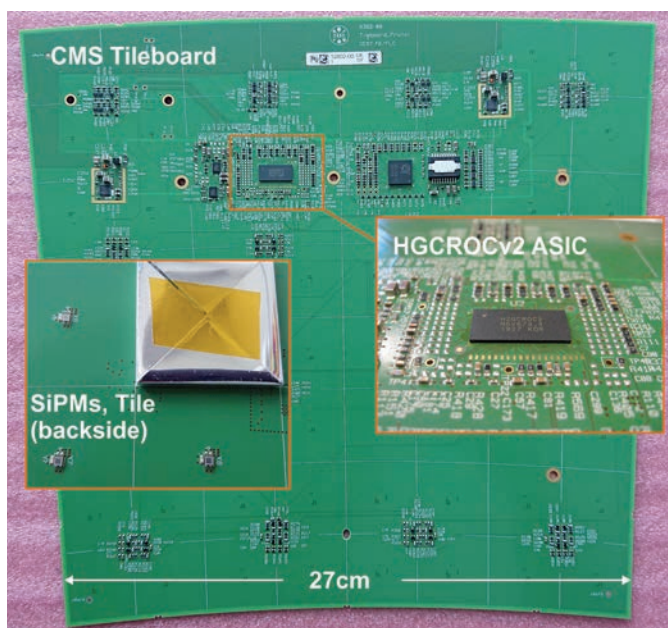


Figure 1  
Prototype of a scintillating-tile detector module (tile board) for the CMS upgrade

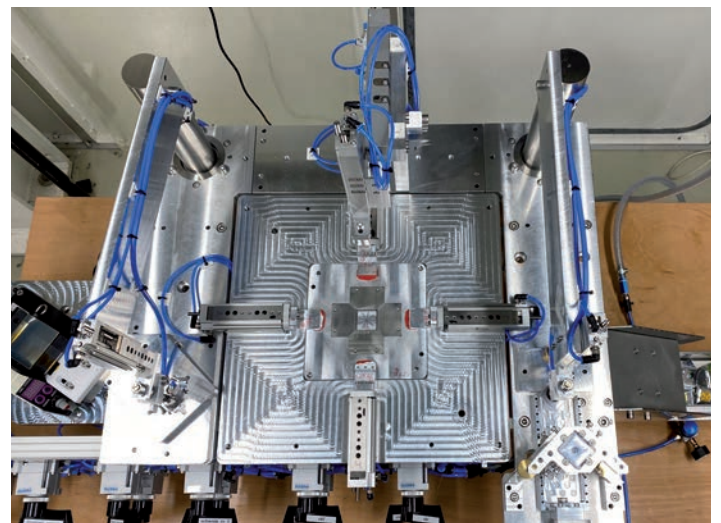


Figure 2  
New facility for the automated wrapping of the scintillating tiles for the detector modules



readout via six 1.28 GBit/s output lines to the data acquisition modules at the barrel end faces. In addition, conflicting requirements have to be fulfilled: On the one hand, the tile boards should be large to cover as much area as possible. On the other hand, very small structures of 100 µm including micro- and buried vias have to be realised inside the printed-circuit board. Finally, all components have to be radiation-hard and will be operated at -30°C.

In total, the CMS barrels will contain around 4000 tile boards. A first prototype was realised in 2019 and is currently being commissioned.

### Automatic scintillating-tile wrapping

Every active detector channel of the detector modules is formed by a scintillating tile and a SiPM. In order to optimise the light yield and reduce the optical crosstalk between the channels, all scintillating tiles will be individually wrapped in a reflecting foil.

In addition to the foreseen number of about 250 000 tiles, the radially growing shape of the detector requires 21 different tile sizes. To accomplish the wrapping in reproducible quality and acceptable time, a tool for automatic wrapping was devised (Fig. 2). The wrapping-tool automation is still in progress. Eventually, a wrapping rate of three to four scintillating tiles per minute is aimed for.

### Detector module assembly

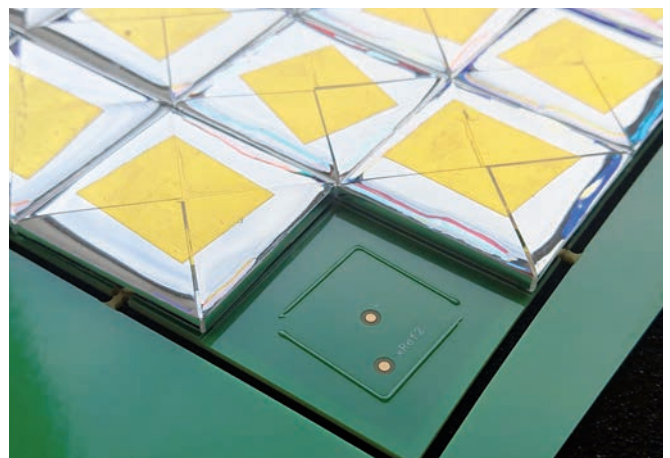
All electrical components on the tile boards are surface-mount devices (SMD) and will be assembled in a standard vapour-phase reflow soldering process (ROHS conformal). For the placement of the SMD components, a new six-head placement automat (Yamaha iPulse) is available at DESY. Most time-consuming is the two-side SMD component assembly, with an expected assembly rate of 20 tile boards per day.

Special care has also been applied to the development of the procedure for placing and gluing the scintillating tiles onto the tile boards. Although an assembly procedure was already developed for this task within the CALICE project [3] using glue print screens, a new technology based on glue dispensing is favoured. The dispensing technique can much better address the variety of 21 different tile sizes in the CMS end-caps, and it is cheaper and more eco-friendly thanks to a significant reduction of the amount of glue required.

For the dispensing process, a new dispensing tool is now available at DESY that can be fixed to the head of the placement automat (Fig. 3). This combination allows the exact definition of how much glue is applied to the tile boards and in which shape. During consecutive assembly of several tile boards, the glue changes its viscosity. In order to guarantee a constant amount of glue applied to the tile boards over time, an automatic glue test is regularly performed, in



**Figure 3**  
New dispensing tool within the SMD placement automat, with the glue cartridge in the foreground



**Figure 4**  
Evaluation of the gluing parameters and assembly technology for the new CMS detector modules (tile boards)

which the viscosity is analysed optically and the dispensing parameters are adjusted accordingly.

The tile-gluing and placement process was evaluated and finalised by practical tests using gluing prototypes (Fig. 4). For a tile board with 64 tiles, the tile assembly took 10 min, including glue dispensing. The stability of the tile gluing was successfully tested in a temperature chamber at -40°C, without any tiles coming off due to thermally induced stress to the gluing. In total, the process proved to be efficient, fast and reliable.

#### Contact:

Otto-Christian Zeides, otto-christian.zeides@desy.de  
Mathias Reinecke, mathias.reinecke@desy.de  
Ole Bach, ole.bach@desy.de  
Felix Sefkow, felix.sefkow@desy.de

#### Reference:

- [1] CERN-LHCC-2017-023; CMS-TDR-019
- [2] OMEGA, <https://portail.polytechnique.edu/omega/en>
- [3] F. Sefkow et al., J. Phys. Conf. Ser. 1162 no.1, 012012 (2019)

The top position of research performed by the centres of the Helmholtz Association is increasingly based on cross-centre and international cooperation as well as on common access to data treasure and services. Likewise, the significance of a sustainable software development for the research process is increasingly recognised. As a newly established IT infrastructure platform, Helmholtz Federated IT Services (HIFIS) aims at uniting the capabilities of the Helmholtz community and promoting science on a broad spectrum, ranging from large-scale and computationally demanding projects to small-scale and focused research works. With its experience in providing high-end IT services to the scientific community, DESY plays the leading role in building this overarching platform. DESY coordinates HIFIS and strongly contributes to two of the three main competence clusters.

### The goal

The newly established HIFIS platform [1] aims at building an outstanding federated infrastructure for the information technology of the Helmholtz Association. DESY has the central and coordinating position within the platform, which involves 11 of the 19 Helmholtz centres distributed over Germany. The goal of HIFIS is to combine the capabilities of all the Helmholtz centres in order to build a secure and easy-to-use collaborative environment with services that are efficiently accessible from anywhere. This ultimately aims at the development of new research activities with a high level of quality, visibility and sustainability.

The HIFIS platform is in line with the Helmholtz Information & Data Science Incubator [2], pursuing the goal of bundling and strengthening the Helmholtz community's activities in the vast spectrum of big-data analytics and computation. The full establishment of HIFIS will improve the foundation for even more elaborate connections to European collaboration communities (Fig. 1A), especially within the context of the European Open Science Cloud (EOSC) [3].

### The way to go

To achieve this, three competence clusters have been installed within the HIFIS collaboration, which are distributed throughout different Helmholtz centres: a cloud services

cluster (federated platform for proven first-class cloud services), a backbone services cluster (high-performance trusted network infrastructure with unified basic services) and a software services cluster (platform, training and support for high-quality, sustainable software development). The portfolio of services to be provided is determined and prioritised based on an extensive study involving all Helmholtz centres.

### Where we are

DESY pioneers the implementation of two of the three competence clusters. The very first one, the backbone services cluster, is responsible for supplying a stable network infrastructure for federated core services to the whole community (Fig. 1B) and prospectively to the scientific world. Depending on the needs of the high-level applications to be implemented, the provided backbone services must account for multiple demands including data protection, transfer speeds, availability, etc. Furthermore, the services must be easy to use for the end user, and the platform should be easy to join for additional service providers, for example introducing new services to the HIFIS service portfolio. Despite being still in the early stages, the most important backbone infrastructures have already been technically implemented, and first preliminary HIFIS services are being established, including DESY services such as dCache [4]. The increasingly available services will be evaluated throughout the Helmholtz community.

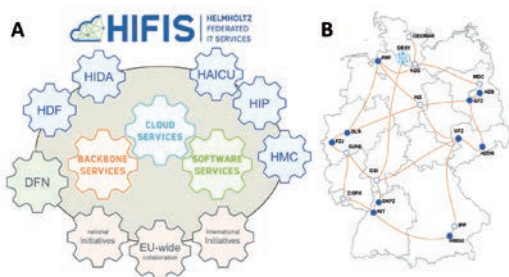


Figure 1

A) Structure of HIFIS and connection to national and international initiatives. B) Backbone connection schematics of Helmholtz centres (HIFIS centres in filled circles).

#### Contact:

Uwe Jandt, [uwe.jandt@desy.de](mailto:uwe.jandt@desy.de) (HIFIS platform coordinator)  
Patrick Fuhrmann, [patrick.fuhrmann@desy.de](mailto:patrick.fuhrmann@desy.de)

#### References:

- [1] [www.hifis.net](http://www.hifis.net)
- [2] [www.helmholtz.de/en/research/information-data-science/helmholtz-incubator/](http://www.helmholtz.de/en/research/information-data-science/helmholtz-incubator/)
- [3] [www.eosc-portal.eu](http://www.eosc-portal.eu)
- [4] [www.dcache.org](http://www.dcache.org)



# IDAF: Interdisciplinary Data Analysis Facility

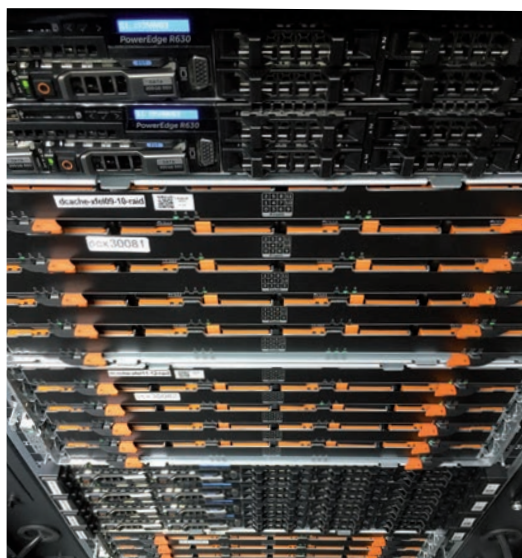
From the Grid, NAF and Maxwell HPC to a combined computing platform

The DESY IT group provides compute and storage resources to all branches of science at DESY, such as high-energy physics, photon science and accelerator research, development and operation. Currently, different communities use different systems: The high-throughput computing resources in the Grid and National Analysis Facility (NAF) are mostly used by high-energy physics, while the Maxwell high-performance computing (HPC) cluster primarily serves photon science and accelerator needs. To link these compute infrastructures together, the Interdisciplinary Data Analysis Facility (IDAF) is currently being designed based on cutting-edge technologies. It will go into operation in the next Helmholtz funding period (PoF IV, 2021–2027).

## Status

Compute resources at DESY are currently available in three systems: The high-throughput Grid cluster is used as a Tier-2 site, among others by the ATLAS, CMS and Belle II collaborations. The NAF serves the German high-energy physics community as a complement to the Grid resources for interactive user analyses. The Maxwell HPC cluster hosts photon science (PETRA III, FLASH and European XFEL) and accelerator research and development activities, as well as parts of accelerator operation with their needs for high-performance computing power.

In addition to these compute systems, DESY IT operates three (main) storage systems: dCache is the main data import/export system for high-energy physics, photon science and accelerator data, including long-term archival on tape. IBM SpectrumScale (GPFS) systems are used for online and offline data store for PETRA III and European XFEL. Further IBM SpectrumScale systems serve as back-end in the NAF for fast and easy-access project storage.



**Figure 1**  
Rack in the computing centre containing IDAF systems

While the clusters are still separated, first measures to enable cross-usage have been taken. The general configurations of Grid and NAF are identical except for scheduling policies, which are currently defined differently for operational reasons. High-energy physics users can use the Maxwell HPC system for GPU work and in an opportunistic way to increase its utilisation.

## New technologies

Users encapsulate and run their applications more and more in containers. This has long been possible in the Maxwell cluster and the Grid and was recently added to the NAF. Interactive access to compute resources via Jupyter was set up for the Maxwell cluster and integrated into the NAF batch scheduling systems, allowing very low-latency access.

## Next steps

Since science at DESY is primarily data-centric, it is important to offer easy, fast, reliable and secure access to data. Currently, not all storage systems are available on all compute resources, sometimes for technical reasons, sometimes for performance and stability reasons. With novel techniques being introduced, the prime requirement is that access to data is offered at a level at least comparable to existing systems. This is a major research topic requiring future work. A tighter integration of container and virtual-machine workloads and infrastructures is on the IDAF roadmap, with the prospect of providing the founding technology to combine the different clusters.

### Contact:

Thomas Hartmann, [thomas.hartmann@desy.de](mailto:thomas.hartmann@desy.de)  
Yves Kemp, [yves.kemp@desy.de](mailto:yves.kemp@desy.de)  
Frank Schlünzen, [frank.schluenzen@desy.de](mailto:frank.schluenzen@desy.de)  
Christian Voss, [christian.voss@desy.de](mailto:christian.voss@desy.de)

# Accelerating machine learning applications

Applications and services at DESY IT for machine learning with focus on photon science

Machine learning (ML) has become a crucial tool in various areas at DESY. Applications range from the tuning of accelerators to the analysis of 3D biomedical data. The successful application of ML requires a substantial knowledge of the methodologies and the availability of powerful compute resources tailored to the task. The DESY IT group has established an expert forum on campus, which ensures the knowledge exchange across different scientific communities. In particular, collaborations with various DESY groups, supported by a significant extension of the Maxwell high-performance computing (HPC) cluster, have successfully tackled imaging problems, thereby greatly improving and accelerating the analysis of biomedical data.

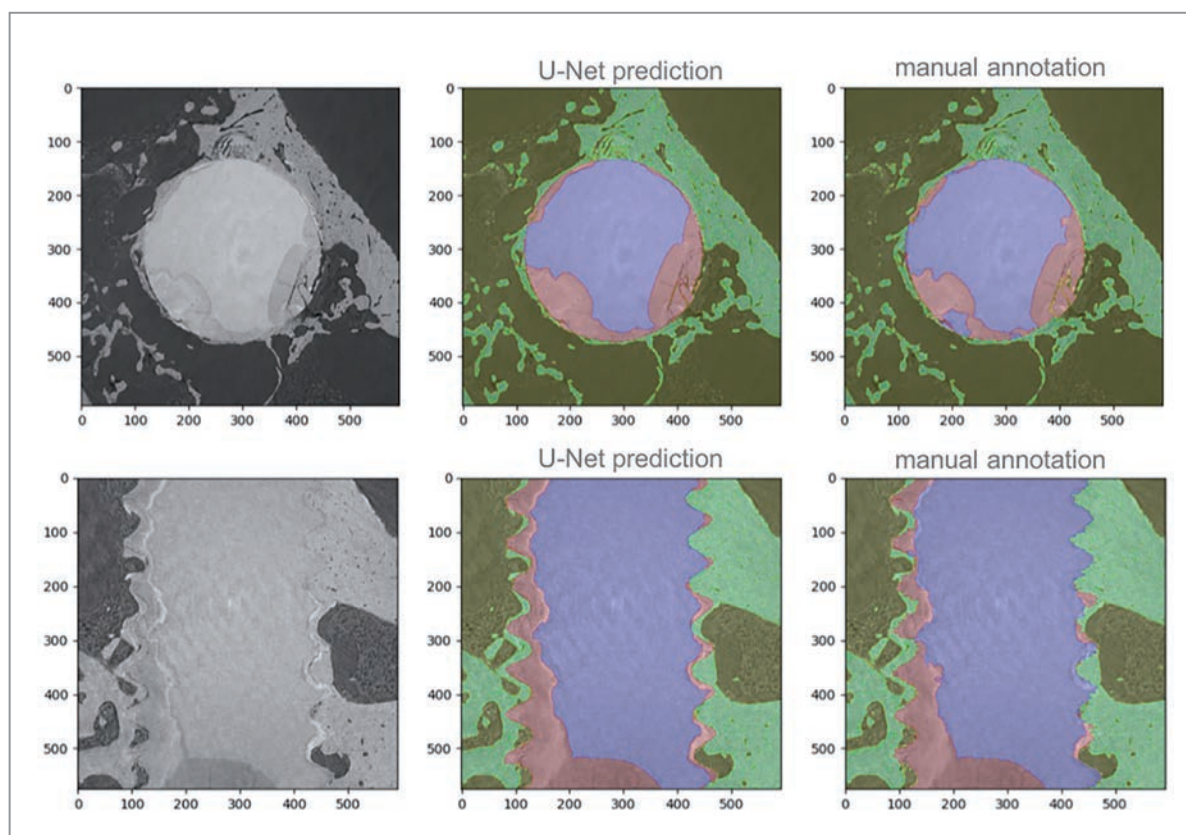
## Applying ML to imaging problems

It is a common notion that data are the oil of the 21<sup>st</sup> century. Like oil, data need quite a bit of processing to become useful. In view of the ever-increasing data rates and volumes originating from experiments at PETRA III or the European XFEL, a high level of automation and, in some cases, a rapid pre-processing become increasingly indispensable.

In imaging experiments in particular, the visualisation and interpretation of 3D data still require a human expert. With

thousands of data sets and millions of images at hand, this tedious and time-consuming task becomes an impossible one. To free scientists from the routine task of visual image inspection, DESY IT has initiated a number of collaborations offering the ML expertise and resources to address this type of challenges.

One example is the segmentation of 3D images obtained by computed tomograms using synchrotron radiation. Our collaborators at Helmholtz-Zentrum Geesthacht (HZG), for



**Figure 1**  
Comparison of the segmentation by the trained U-Net CNN with the semi-manual segmentation. (Blue: residual screw, red: corrosion, green: bone). Although trained on poorly annotated data (incomplete, inconsistent, partially false labels), the U-Net prediction outperforms the semi-manual segmentation (in collaboration with Julian Moosmann, Berit Zeller Plumhoff and Diana Krüger, HZG).



example, are collecting data from biodegradable materials, namely screws inserted into rat bones. These screws degrade over time. To analyse their material-dependent degradation behaviour, it is crucial to identify the areas in the 3D images representing the screw, degraded screw and bone. The precise labelling of one data set by hand usually takes about two to three weeks. To date, a few hundred data sets have already been collected, and the number is still growing.

We have been investigating the applicability of deep-learning methods to automatise this challenging task of labelling, called segmentation. To this end, we have trained a convolutional neural network (CNN), a so-called U-Net, using a small number of these data sets, which had been annotated in a quick and dirty approach by human experts. The application of the trained network yields a more precise segmentation than would be possible with any quick manual approach [1] (Fig. 1). The automatic U-Net segmentation takes about one hour per data set using the DESY Maxwell HPC cluster.

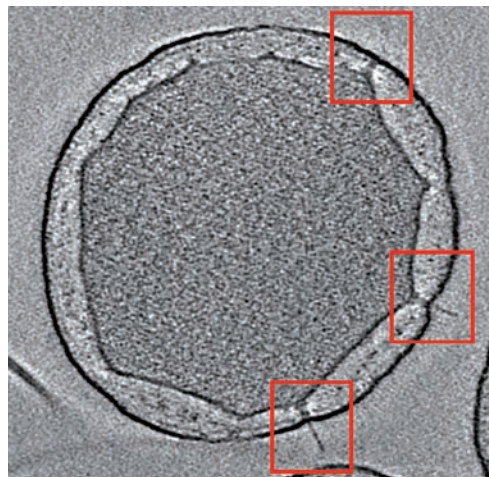
Our partners at the Centre for Structural Systems Biology (CSSB) are using cryo-electron microscopy tomography to take 3D images from entire cells in order to study protein transmembrane complexes. The general idea of the experiment is to identify all instances of the protein complex under investigation in the 3D tomograms and apply subtomogram averaging. In subtomogram averaging, all instances are superimposed and averaged, eventually yielding a 3D structure of the protein complex at far higher resolution than the images initially taken. The first step in this pipeline, however, is the identification of the transmembrane complexes in the images. Identification by hand in thousands of 3D volumes is a very tedious and time-consuming procedure.

This object identification task can also be automatized by developing and training a deep-learning algorithm. To this end, we have applied a patchwise CNN classification algorithm, combined with a U-Net for prior identification of the membrane. The final optimisation of the automatic procedure is still under investigation, but preliminary results obtained using the Maxwell cluster are very promising (Fig. 2).

The third deep-learning project currently under development within DESY IT concerns the utilisation of CNNs for the identification of European XFEL diffraction patterns, in particular from experiments at the SPB/SFX instrument, with the ultimate goal to provide a fast and robust filtering procedure to support data reduction.

## ML forums at DESY

The application of ML is increasingly being investigated in many groups across the DESY campus. Independent of the scientific focus, the methods and tools used for ML-related research are often the same. To connect and train the scientists and software developers across the campus, DESY IT has initiated a very well-visited monthly seminar dedicated to teaching ML methods. DESY IT also hosts an annual round



**Figure 2**  
Slice from a cryo-electron microscopy tomogram. The red boxes indicate instances of transmembrane proteins, identified by CNN for subsequent subtomogram averaging (in collaboration with Thomas Marlovits and Sean Miletic, UKE/CSSB)

table event to discuss recent advances achieved with ML on campus. To allow easy interdisciplinary communication on ML and announce ML-related events, we offer a dedicated ML mailing list.

## Infrastructures for ML and beyond

Simulations and data generated in the context of photon science experiments at PETRA III, FLASH or the European XFEL are ultimately stored on fast cluster file systems. These storage elements are an integral component of the Maxwell cluster, which serves the computational needs of the photon science communities using any of the instruments at DESY.

Most ML-based data processing and analysis require very substantial GPU resources, in particular for training neural networks. With the large increase of ML applications, the demands for GPU compute time has strongly grown as well. To alleviate the greatest need, DESY IT and other groups have hence made major investments to increase the number of machines with state-of-the-art GPUs by a factor of 5 over the last two years.

To ease the use of and access to the GPU resources, DESY IT provides a fairly complete set of ML software packages, which can readily and conveniently be used through the central Jupyter hub on Maxwell (<https://max-jhub.desy.de>).

The importance of the Maxwell cluster for photon science is reflected by the significant number of publications in which the cluster has reportedly played a crucial role for data analysis and simulations [2].

### Contact:

Philipp Heuser, [philipp.heuser@desy.de](mailto:philipp.heuser@desy.de)  
Frank Schlünzen, [frank.schluenzen@desy.de](mailto:frank.schluenzen@desy.de)

### Reference:

- [1] Julian Moosmann et al., Proc. SPIE 11113, Developments in X-Ray Tomography XII, 1111318 (2019)
- [2] <https://confluence.desy.de/display/IS/Publications>

# Plasma speed bump

## FLASHForward demonstrates first electron beam formation

Plasma wakefield accelerator research has seen great interest in recent years due to the prospect of achieving accelerating gradients that exceed the GV/m threshold [1]. The FLASHForward project [2] – an extension to the FLASH facility at DESY – is designed to exploit the free-electron laser (FEL)-quality electron beams provided by the FLASH front end in order to explore wakefield acceleration in a highly stable environment. One aim of the project is to study the trapping and acceleration of an additional electron bunch formed directly from the plasma background. Here, we report on the first observation of internal injection at FLASHForward, a critical milestone on the path to high-quality beam generation from plasma.

### First milestones on the way to high-brightness beams from plasma

High-brightness particle beams are ever in demand. For example, for collider applications, high-quality beams can be tightly focused at the interaction point, with their small foci resulting in a high luminosity and therefore multiple events per bunch crossing. In the context of FELs, lasing places a number of requirements on the properties of the electron beam, including high charge and short bunch lengths. In both examples, producing high-quality beams with these qualities typically requires precision machines, which involve significant construction costs. Thus, reducing the size and scale of these machines may facilitate the construction of university-scale FELs, the likes of which have been previously limited to large facilities and national laboratories. Alternatively, plasma-based devices may provide an upgrade pathway for conventional accelerators with extremely compact modules that can boost the brightness and/or energy of the beams.

The frequently cited GV/m-scale accelerating gradients produced by plasma accelerators are formed when a beam is incident into a plasma. The driving beam may either be an

intense laser pulse or a particle beam. In its most extreme, this driving beam expels all electrons from the central region, resulting in a bubble or blowout that is devoid of plasma electrons. To harness these gradients, a secondary or witness electron beam must be placed behind the driving beam in order to be accelerated by the resulting wakefield. The witness beam may either be sourced from a conventional accelerator and externally injected into the wake, or formed from within the plasma target, or internally injected. These methods have the potential to produce beams with the desired short bunch lengths and low emittances suitable for applications in which high brightness is desired [3, 4].

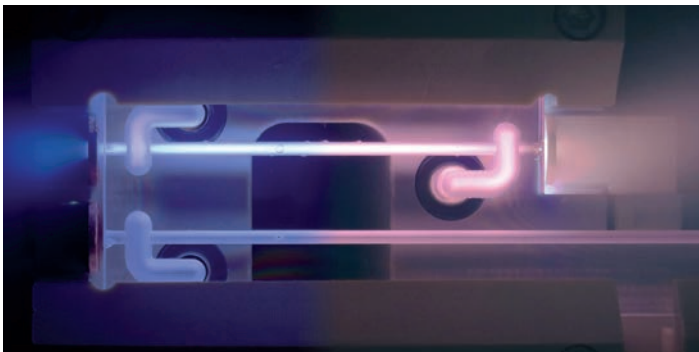
### Trapping of plasma electrons

To produce high-quality beams and be able to precisely tune their properties for high-brightness applications, even more precise control over the injection mechanism is required. Multiple methods have been proposed in order to achieve this, many of which rely on a controlled release of atomic electrons directly into the wake [3, 4].

One additional method is known as density down-ramp (DDR) injection, which can be achieved using a so-called plasma speed bump – a small region of increased plasma density. This region has three distinct features: an up-ramp, a flat-top plateau and a down-ramp. The wakefield period scales inversely with the square root of the plasma density:

$$\lambda_p \sim n_e^{-\frac{1}{2}}$$

Hence, the presence of such features will have a strong influence on the wakefield. On the up-ramp, the wake period will decrease in size and remain that size until it reaches the down-ramp. As it traverses the down-ramp, its length will increase and the electrons, which previously formed the boundary of the bubble, will now have trajectories that may bring them into the accelerating region, where they can be trapped and accelerated.



**Figure 1**  
Composite image of the short plasma cell (top) used in the experiment on top of the first section of the long capillary. The composite illustrates plasma light from the ionisation of argon (left) and helium (right), the two gas species utilised in the experiment.



In more stringent terms, the down-ramp reduces the phase velocity of the plasma wake, which allows the electrons – moving at close to the speed of light – to propagate forward into the accelerating region, resulting in a plasma speed bump. The shape and gradient of these down-ramps are therefore critical to the injection process [3], and hence control over the shape is an essential aspect of the experiment. Laser ionisation by a laser pulse that propagates perpendicularly to the driving electron beam provides a straightforward and flexible path towards this goal. The shape and intensity of the focus will have a direct impact on the profile of the down-ramp and provide a measure of control over the injected bunches.

### Three-beam temporal and spatial overlap

In November 2019, the FLASHForward team performed an experimental campaign that aimed to demonstrate the internal injection of plasma electrons into a beam-driven wake. This required the overlapping of three beams – the longitudinal ionisation laser, the transverse ionisation/injection laser and the electron bunch driver – in both space and time inside a capillary plasma source (Fig. 1). The beams were spatially overlapped using a diagnostic screen placed upstream of the capillary. Temporal overlap required a level of precision orders of magnitude finer than the exposure time of most cameras, thus necessitating the use of a novel plasma-based method [6].

An electron beam arriving after the laser would find a pre-ionised plasma in which it would drive a wakefield and lose energy. This energy deposition was observed via a CCD camera in the form of an increased light output from the plasma, which was absent when the electron beam was either absent or arrived before the laser pulse. This “plasma glow” was used to achieve temporal overlap on a picosecond time scale.

### Active beam control

Once overlap in both space and time was achieved, all three beams were aligned through the short capillary. Injected beams were observed for the first time, accelerated to a mean energy of 45 MeV over 30 mm of plasma – corresponding to a mean accelerating gradient of 1.5 GV/m – with an average charge of 28 pC. An example of one of the first bunches experimentally observed can be seen in Fig. 2. The origin of these beams was investigated and confirmed by progressively blocking and unblocking the laser arm used to produce the down-ramp. Figure 3 shows the result of this simple check, with beams only present on the spectrometer when the injection laser was unblocked.

Significant jitter effects were seen during the experimental campaign; understanding and resolving their origin is critical to refining the injection and acceleration process. In 2020, the FLASHForward team will extend these results by investigating and ultimately mitigating the sources of jitter and instability. In addition, by transitioning from the “short” to the “long” plasma capillary, facilitating a total 175 mm of acceleration

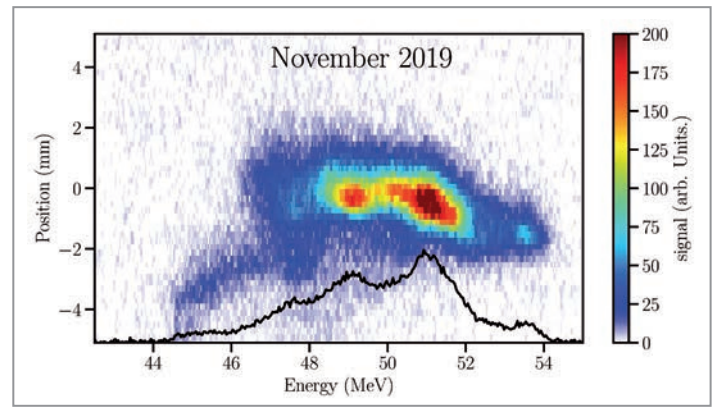


Figure 2

Energy spectrum of one of the first internally injected bunches at FLASHForward

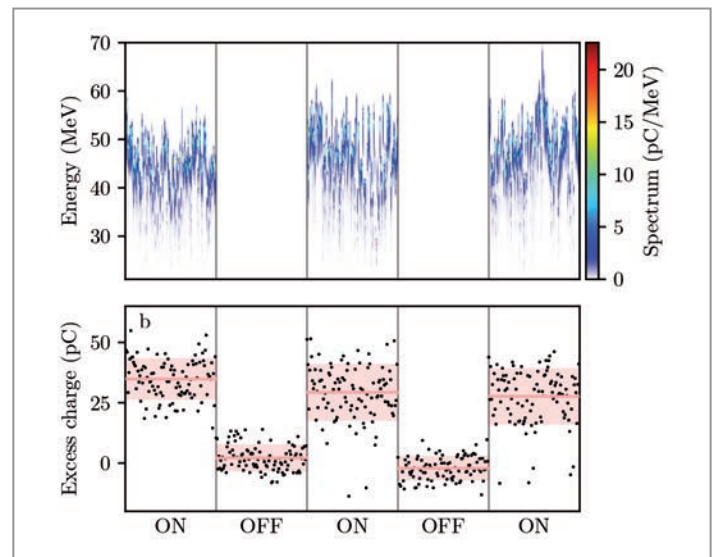


Figure 3

Energy spectra (top) and excess charge (bottom) as measured in the beamline during a scan in which the injection laser arm was progressively switched on and off

length, the team expects the beams to reach significantly higher energies in the upcoming studies. These beams will then be transported to recently commissioned diagnostics located further downstream in the FLASHForward beamline. For example, the new prototype X-band transverse deflection structure (Polarix) offers the potential to characterise these beams in 6D phase space.

The future of high-brightness beams at FLASHForward looks bright indeed!

#### Contact:

Bridget Sheeran, [bridget.sheeran@desy.de](mailto:bridget.sheeran@desy.de)

#### Reference:

- [1] T. Tajima and J. M. Dawson, *Phys. Rev. Lett.*, 43 (4), 267–270 (1979)
- [2] R. D’Arcy et al., *Philos. Trans. R. Soc. A Math. Phys. Eng. Sci.* 377, 20180392 (2019)
- [3] A. Martinez de la Ossa et al., *Phys. Rev. Accel. Beams* 20, 091301 (2017)
- [4] B. Hidding et al., *Phys. Rev. Lett.*, 108:035001 (2012)
- [5] A. Martinez de la Ossa et al., *Phys. Plasmas* 22, 093107 (2015)
- [6] P. Scherkl et al., *arXiv preprint arXiv:1908.09263*.





ANNUAL  
REVIEW  
OF  
NUCLEAR  
SCIENCE



VOL. 12  
1962

ANNUAL  
REVIEW  
OF  
NUCLEAR  
SCIENCE



VOL. 13  
1963

ANNUAL  
REVIEW  
OF  
NUCLEAR  
SCIENCE



VOL. 14  
1964

ANNUAL  
REVIEW  
OF  
NUCLEAR  
SCIENCE



VOL. 15  
1965

K

K

K

K

Ann  
14

Ann  
15





## References

> Committees	82
> Memberships	86
> Publications	88

# Committees

## DESY Foundation Council

### Representatives of the Federal Republic of Germany

**T. Stolzenberg**

(Federal Foreign Office)

RD'in **Dr. A. Fischer**

(Federal Ministry of Education and Research)

MinR Dr. **V. Dietz** (Chair)

(Federal Ministry of Education and Research)

### Representatives of the Free and Hanseatic City of Hamburg

LRD Dr. **R. Greve** (Deputy Chair)

(Ministry of Education and Research)

**N. Abend**

(Ministry of Education and Research)

### Representatives of the Federal State of Brandenburg

**H. Roth**

(Ministry of Finance)

MR **C. Feller**

(Ministry of Science, Research and Culture)

### Representatives from science and industry

Prof. Dr. **A. Brückner**

(Leibniz-Institut für Katalyse e.V.)

Prof. Dr. **D. Lenzen**

(President of Universität Hamburg)

Dr. **M. Kraas**

(Olympus Surgical Technologies)

Dr. **G. Mecke**

(AIRBUS)

### Guests

Dr. **R. Abela**

(Chair of the DESY Scientific Council)

Prof. Dr. **R. Röhlsberger**

(Chair of the DESY Scientific Committee)

Prof. Dr. **O. Wiestler**

(President of the Hermann von Helmholtz Association)

**A.-C. Jauch**

(DESY Equal Opportunity Officer)

**C. Joithe**

(Chair of DESY Works Council)

## DESY Board of Directors

Prof. Dr. **H. Dosch**

(Chairman of the DESY Board of Directors)

**C. Haringa**

(Administrative Division)

Dr. **W. Leemans**

(Accelerator Division)

Prof. Dr. **J. Mnich**

(Particle Physics Division)

Prof. Dr. **E. Weckert**

(Photon Science Division)

Prof. Dr. **C. Stegmann**

(Astroparticle Physics Division)



## DESY Scientific Council

Dr. **R. Abela**  
PSI (CH)

Prof. Dr. **O. Botner**  
Uppsala University (SE)

Prof. Dr. **W. Barletta**  
MIT (USA)

Prof. Dr. **K. Hämäläinen**  
University of Helsinki (FIN)

Prof. Dr. **J. Hill**  
BNL (USA)

Prof. Dr. **Y.-K. Kim**  
University of Chicago (USA)

Prof. Dr. **T. Lohse**  
Humboldt University Berlin (DE)

Prof. Dr. **J. McEnery**  
NASA (USA)

Prof. Dr. **L. Merminga**  
Fermilab (USA)

Dr. **B. Murphy**  
Christian-Albrechts-University Kiel (DE)

Prof. Dr. **L. Rivkin**  
PSI (CH)

Prof. **B. Roldán Cuenya**  
Fritz Haber Institute (DE)

Prof. Dr. **T. Salditt**  
University of Göttingen (DE)

Prof. Dr. **J. Ullrich**  
Physikalisch-Technische Bundesanstalt (DE)

Prof. **C. Wahlström**  
Lund University (SE)

Prof. Dr. **N. Wermes**  
University of Bonn (DE)

and the chairpersons of

**DESY APC:**  
Dr. **C. Weinheimer**, University of Münster (DE)

**DESY MAC:**  
Dr. **O. Bruening**, CERN (CH)

**DESY PRC:**  
Prof. Dr. **P. Burrows**, University of Oxford (UK)

**DESY PSC:**  
Dr. **Ch. David**, PSI (CH)

**DESY Scientific Committee:**  
Prof. Dr. **R. Röhlsberger**, DESY

**European XFEL:**  
Prof. Dr. **R. Feidenhans'l**, European XFEL (DE)

## DESY Scientific Committee

Elected members from

FH Hamburg:

**K. Büßer** (DESY/FLC)  
**M. Diehl** (DESY/T)  
**V. Gülzow** (DESY/IT)  
**I.M. Gregor** (DESY/ATLAS)  
**S. Heim** (DESY/ATLAS)  
**H. Jansen** (DESY/CMS)  
**I. Melzer-Pellmann** (DESY/CMS)  
**A. Mußgiller** (DESY/CMS)  
**C. Niebuhr** (DESY/Belle)  
**A. Ringwald** (DESY/ALPS)  
**T. Schörner-Sadenius** (DESY/CMS)  
**P. van der Reest** (DESY/IT)

FS Division:

**S. Bari** (DESY/FS-SCS)  
**A. Burkhardt** (DESY/FS-PE)  
**R. Döhrmann** (DESY/FS-PE)  
**H. Graafsma** (DESY/FS-DS)  
**T. Laarmann** (DESY/FS-PS)  
**N. Müller** (DESY/FSR)  
**E. Plönjes-Palm** (DESY/FS-FL)  
**R. Röhlberger** (DESY/FS-PS)  
**H. Schulte-Schrepping** (DESY/FS-BT)  
**O. Seeck** (DESY/FS-PE)  
**M. Tischer** (DESY/FS-US)  
**R. Treusch** (DESY/FS-FL)

M Division:

**N. Baboi** (DESY/MDI)  
**M. Bieler** (DESY/MBB)  
**U. Dorda** (DESY/MPY)

**H.-J. Eckold** (DESY/MKK)  
**K. Honkavaara** (DESY/MPY)  
**R. Kammering** (DESY/MCS)  
**G. Kube** (DESY/MDI)  
**L. Lilje** (DESY/MVS)  
**S. Schreiber** (DESY/MFL)  
**M. Schmitz** (DESY/MIN)  
**N. Walker** (DESY/MPY)

V Division:

**S. Haid** (DESY/VQ)  
**I. Mahns** (DESY/ITT)  
**C. Porthun** (DESY/D4)

Zeuthen Campus:

**M. Ackermann** (DESY/Z\_ICE)  
**I. Bloch** (DESY/Z\_DLAB)  
**J. Knapp** (DESY/Z\_GA)  
**S. Ohm** (DESY/Z\_HESS)  
**W. Winter** (DESY/AP\_THAT)

Delegates from partner institutes  
and committees:

**S. Fiedler** (EMBL)  
**J. Haller** (U Hamburg)  
**J. Dietrich** (HU Berlin)  
**S. Köster** (KfS)  
**D. Lott** (HZG)  
**S. Molodtsov** (European XFEL)  
**N.N.** (KAT)  
**N.N.** (KET)  
**N.N.** (KfB)  
**N.N.** (U Hamburg)

Leading Scientists:

**R. Aßmann** (DESY/MPY)  
**T. Behnke** (DESY/FLC)  
**K. Borras** (DESY/CMS)  
**R. Brinkmann** (DESY/MPY)  
**F. Calegari** (DESY/FS-CFEL)  
**H. Chapman** (DESY/FS-CFEL)  
**B. Foster** (DESY/FLA)  
**E. Gallo** (DESY/CMS)  
**C. Grojean** (DESY/T)  
**G. Grübel** (DESY/FS-CSX)  
**B. Heinemann** (DESY/ATLAS)  
**Ç. İşsever** (DESY/ATLAS)  
**F. Kärtner** (DESY/FS-CFEL)  
**M. Kasemann** (DESY/CMS)  
**M. Kowalski** (DESY/Z\_ICE)  
**K. Mönig** (DESY/ATLAS)  
**K. Peters** (DESY/ATLAS)  
**M. Pohl** (DESY/Z\_THAT)  
**K. Rossnagel** (DESY/FS-SXQM)  
**N. Rohringer** (DESY/FS-TUX)  
**R. Santra** (DESY/FS-CFEL)  
**M. Schnell-Küpper** (DESY/FS-SMP)  
**V. Schomerus** (DESY/T)  
**C. Schroer** (DESY/FS-PETRA)  
**C. Schwanenberger** (DESY/CMS)  
**G. Servant** (DESY/T)  
**A. Stierle** (DESY/FS-NL)  
**K. Tackmann** (DESY/ATLAS)  
**S. Techert** (DESY/FS-SCS)  
**G. Weiglein** (DESY/T)  
**H. Weise** (DESY/MPY)  
**W. Wurth** (DESY/FS-FLASH)  
**H. Yan** (DESY/Z\_THAT)



## Physics Research Committee (PRC)

Prof. Dr. **P. Burrows** (U Oxford, UK, Chair)  
Prof. Dr. **A. Boehnlein** (JLab, USA)  
Prof. Dr. **L. Covi** (U Göttingen, DE)  
Prof. Dr. **L. Feld** (RWTH Aachen, DE)  
Prof. Dr. **J. Fuster Verdú** (IFIC Valencia, SP)  
Prof. Dr. **N. Glover** (IPPP Durham, UK)  
Prof. Dr. **U. Husemann** (KIT, DE)  
Prof. Dr. **Y. Semertzidis** (KAIST Seoul, KR)

Ex-officio members in MAC and PRC:

Prof. Dr. **H. Dosch** (DESY)  
Dr. **W. Leemans** (DESY)  
Prof. Dr. **J. Mnich** (DESY)  
Prof. Dr. **C. Stegmann** (DESY)  
Prof. Dr. **E. Weckert** (DESY)

## German Committee for Particle Physics (KET)

**S. Bethke** (MPP München)  
**M. Beneke** (TU München)  
**V. Büscher** (U Mainz)  
**A. Caldwell** (MPP München)  
**K. Desch** (U Bonn)  
**F. Ellinghaus** (U Wuppertal)  
**M. Elsing** (CERN)  
**E. Garutti** (U Hamburg)  
**T. Hebbeker** (RWTH Aachen)  
**M. Kobel** (TU Dresden)  
**J. List** (DESY)  
**J. Mnich** (DESY)  
**P. Schleper** (U Hamburg)  
**U. Uwer** (U Heidelberg, Chair)  
**G. Weiglein** (DESY)

# Memberships

**Accelerator Advisory Committee AAC Fermilab**  
Hans Weise

**Accelerator Research and Innovation for European Science and Society (ARIES)**  
Ralph Aßmann (Deputy Chair)

**ACHIP Consortium Advisory Board, Moore Foundation**  
Reinhard Brinkmann

**ACOT – Advisory Committee of TRIUMF**  
Volker Gülzow

**AIDA-2020**  
Katja Krüger, Felix Sefkow

**Akademie der Wissenschaften Hamburg**  
Wilfried Buchmüller

**arXiv Scientific Advisory Board**  
Martin Köhler

**ATLAS Collaboration Board**  
Klaus Mönig

**ATLAS Tracker Upgrade Management Board**  
Ingrid Gregor

**Auswahlkommission der Carl-Zeiss-Stiftung**  
Joachim Mnich (Chair)

**BELLE II Scrutiny Committee**  
Karsten Büßer (Chair)

**BNL Programme Advisory Committee, Machine Advisory Committee**  
Ralph Aßmann

**CALICE Steering Board**  
Felix Sefkow

**CERN Scientific Policy Committee**  
Reinhard Brinkmann

**CMS Collaboration Board**  
Kerstin Borras  
Matthias Kasemann (Chair)

**CMS Management Board**  
Kerstin Borras

**CMS Tracker Institution Board**  
Günter Eckerlin

**Deutsches Forschungsnetz DFN Verwaltungsrat**  
Joachim Mnich

**DPG Beirat Fachverband Teilchenphysik**  
Ties Behnke

**DPG National Prize Committee**  
Georg Weiglein

**DPG Wissenschaftlicher Beirat des Physikzentrums**  
Georg Weiglein

**DPHEP International Steering Committee**  
Volker Gülzow

**ERC Panel Member**  
Georg Weiglein

**EuPRAXIA**  
Jens Osterhoff (Chair of WP9), Ralph Aßmann (CB Member), Reinhard Brinkmann (CB Member)

**European Committee for Future Accelerators (ECFA)**  
Joachim Mnich

**European Particle Physics Communication Network**  
Thomas Zoufal

**European Strategy Group (ESG)**  
Joachim Mnich

**Future Circular Collider (FCC) Collaboration Board**  
Ralph Aßmann

**Galileo Galilei Institute (INFN) Scientific Committee**  
Christophe Grojean

**Gauß Allianz**  
Volker Gülzow

**German Executive Outreach Group (GELOG)**  
Matthias Kasemann, Thomas Naumann,  
Barbara Warmbein, Thomas Zoufal

**GridKa Overview Board**  
Volker Gülzow

**Hamilton Mathematics Institute, Trinity College Dublin, Advisory Board**  
Volker Schomerus

**Helmholtz Arbeitskreis Bibliotheks- und Informationsmanagement**  
Martin Köhler

**Helmholtz Programme Matter and Technologies**  
Ties Behnke (Spokesperson)

**Helmholtz Research Topic Elementary Particle Physics**  
Joachim Mnich (Spokesperson)



**Helmholtz Alliance "Physics at the Terascale"**  
Ties Behnke (Scientific Coordinator)

**IESC Scientific Committee**  
Géraldine Servant

**INFN/LNF Scientific Committee**  
Ralph Aßmann

**INSPIRE directorate**  
Kirsten Sachs

**Interactions Collaboration Board**  
Christian Mrotzek

**International Committee for Future Accelerators (ICFA)**  
Brian Foster, Joachim Mnich

**International Large Detector**  
Ties Behnke (Spokesperson)

**IT-Koordinierungsausschuss (KoDa)**  
Volker Gülzow (Chair)

**Jefferson Lab Programme Advisory Committee**  
Markus Diehl

**John Adams Institute Advisory Board**  
Reinhard Brinkmann (Chair)

**John von Neumann Institute for Computing (NIC)**  
Joachim Mnich (Director)

**Joint Institute for Nuclear Research JINR, Programme Advisory Committee for Particle Physics**  
Joachim Mnich

**Joint Institute for Nuclear Research JINR, Scientific Council**  
Joachim Mnich

**Komitee für Beschleunigerphysik**  
Ralph Aßmann (Deputy Chair), Jens Osterhoff

**Komitee für Elementarteilchenphysik (KET)**  
Kerstin Borras, Jenny List, Joachim Mnich, Georg Weiglein

**LCC Physics and Detector Executive Board**  
Ties Behnke, Karsten Büber, Frank Gaede (Chair), Jenny List

**LHC Computing Resources Review Board**  
Volker Gülzow

**LHC Computing Resources Scrutiny Group**  
Frank Gaede

**LHC Resources Review Board**  
Manfred Fleischer

**LHC Experiments Committee**  
Katja Krüger

**Linear Collider Board (LCB)**  
Joachim Mnich

**Long-Baseline Neutrino Committee Fermilab**  
Ties Behnke

**NIC Scientific Council**  
Stefan Schäfer

**NIKHEF Scientific Advisory Committee (SAC)**  
Joachim Mnich

**NRC-ACOT Advisory Committee on TRIUMF**  
Hans Weise

**PAC Center for Frontiers in Nuclear Science**  
Markus Diehl (Chair)

**Particle Data Group**  
Brian Foster (Author), Klaus Mönig (Author),  
Andreas Ringwald (Author), Georg Weiglein (Author),  
Christian Spiering (Author)

**Physics Preparatory Group of the European Strategy for Particle Physics**  
Beate Heinemann

**Physics Review Panel, Academy of Finland**  
Christophe Grojean (Chair)

**PIER Executive Board (Research field Particle & Astroparticle Physics)**  
Georg Weiglein

**PIER Research Committee**  
Georg Weiglein

**Royal Society Deputy**  
Brian Foster (Chair)

**Scientific Advisory Committee Super TAU Charm Factory, BNP, Russia**  
Felix Sefkow

**SCOAP<sup>3</sup> Executive Committee**  
Florian Schwennsen

**SuperKEKB Machine Advisory Committee**  
Ralph Aßmann

**TESLA Technology Collaboration**  
Hans Weise (Chair)

**Wolfgang Pauli Centre**  
Volker Schomerus (Chair)

## ALPS

---

### Published

IAXO Collaboration.

**Physics potential of the International Axion Observatory (IAXO).**

*Journal of cosmology and astroparticle physics*, 1906(06):047, and PUBDB-2019-02656, arXiv:1904.09155. doi: 10.1088/1475-7516/2019/06/047.

MADMAX Collaboration.

**A new experimental approach to probe QCD axion dark matter in the mass range above 40  $\mu\text{eV}$ .**

*The European physical journal / C*, 79(3):186, and PUBDB-2019-01463, DESY-19-011; arXiv:1901.07401. doi: 10.1140/epjc/s10052-019-6683-x.

## ATLAS

---

### Published

D. Abercrombie et al.

**Dark Matter Benchmark Models for Early LHC Run-2 Searches: Report of the ATLAS/CMS Dark Matter Forum.**

*Physics of the Dark Universe*, 27:100371, and PUBDB-2020-00471, arXiv:1507.00966; FERMILAB-PUB-15-282-CD. doi: 10.1016/j.dark.2019.100371.

E. Accomando et al.

**PDF Profiling Using the Forward-Backward Asymmetry in Neutral Current Drell-Yan Production.**

*Journal of high energy physics*, 2019(10):176, and PUBDB-2019-04768, arXiv:1907.07727; DESY-19-127; MS-TP-19-19; CERN-TH-2019-110. doi: 10.1007/JHEP10(2019)176.

S. Amoroso et al.

**Estimating QCD uncertainties in Monte Carlo event generators for gamma-ray dark matter searches.**

*Journal of cosmology and astroparticle physics*, 1905(05):007, and PUBDB-2020-00488, arXiv:1812.07424. doi: 10.1088/1475-7516/2019/05/007.

ATLAS Collaboration.

**A search for pairs of highly collimated photon-jets in  $pp$  collisions at  $\sqrt{s} = 13$  TeV with the ATLAS detector.**

*Physical review / D*, D99(1):012008, and PUBDB-2019-03116, arXiv:1808.10515; CERN-EP-2018-143. doi: 10.1103/PhysRevD.99.012008.

ATLAS Collaboration.

**A strategy for a general search for new phenomena using data-derived signal regions and its application within the ATLAS experiment.**

*Zeitschrift für Physik / C*, 79(2):120, and PUBDB-2019-03091, arXiv:1807.07447; CERN-EP-2018-070. doi: 10.1140/epjc/s10052-019-6540-y.

ATLAS Collaboration.

**ATLAS b-jet identification performance and efficiency measurement with  $t\bar{t}$  events in  $pp$  collisions at  $\sqrt{s} = 13$  TeV.**

*The European physical journal / C*, 79(11):970, and PUBDB-2019-05053, arXiv:1907.05120; CERN-EP-2019-132. doi: 10.1140/epjc/s10052-019-7450-8.

ATLAS Collaboration.

**Combination of searches for invisible Higgs boson decays with the ATLAS experiment.**

*Physical review letters*, 122(23):231801, and PUBDB-2019-04959, arXiv:1904.05105; CERN-EP-2019-046. doi: 10.1103/PhysRevLett.122.231801.

ATLAS Collaboration.

**Comparison of Fragmentation Functions for Jets Dominated by Light Quarks and Gluons from  $pp$  and Pb+Pb Collisions in ATLAS.**

*Physical review letters*, 123(4):042001, and PUBDB-2019-03271, arXiv:1902.10007; CERN-EP-2019-009. doi: 10.1103/PhysRevLett.123.042001.

ATLAS Collaboration.

**Constraints on mediator-based dark matter and scalar dark energy models using  $\sqrt{s} = 13$  TeV  $pp$  collision data collected by the ATLAS detector.**

*Journal of high energy physics*, 2019(5):142, and PUBDB-2019-03274, arXiv:1903.01400; CERN-EP-2018-334. doi: 10.1007/JHEP05(2019)142.

ATLAS Collaboration.

**Correlated long-range mixed-harmonic fluctuations measured in  $pp$ ,  $p$ +Pb and low-multiplicity Pb+Pb collisions with the ATLAS detector.**

*Physics letters / B*, B789:444, and PUBDB-2019-03089, arXiv:1807.02012; CERN-EP-2018-151; CERN-PH-EP-2018-151. doi: 10.1016/j.physletb.2018.11.065.

ATLAS Collaboration.

**Cross-section measurements of the Higgs boson decaying into a pair of  $\tau$ -leptons in proton-proton collisions at  $\sqrt{s} = 13$  TeV with the ATLAS detector.**

*Physical review / D*, 99(7):072001, and PUBDB-2019-03154, arXiv:1811.08856; CERN-EP-2018-232. doi: 10.1103/PhysRevD.99.072001.

ATLAS Collaboration.

**Dijet azimuthal correlations and conditional yields in  $pp$  and  $p$ +Pb collisions at  $\sqrt{s_{NN}} = 5.02$  TeV with the ATLAS detector.**

*Physical review / C*, 100(3):034903, and PUBDB-2019-03205, arXiv:1901.10440; CERN-EP-2018-324. doi: 10.1103/PhysRevC.100.034903.

ATLAS Collaboration.

**Electron and photon energy calibration with the ATLAS detector using 2015–2016 LHC proton-proton collision data.**

*Journal of Instrumentation*, 14(03):P03017, and PUBDB-2019-03195, arXiv:1812.03848; CERN-EP-2018-296. doi: 10.1088/1748-0221/14/03/P03017.



ATLAS Collaboration.

**Electron and photon performance measurements with the ATLAS detector using the 2015–2017 LHC proton-proton collision data.**

*Journal of Instrumentation*, 14(12):P12006, and PUBDB-2020-00492, arXiv:1908.00005; CERN-EP-2019-145.  
doi: 10.1088/1748-0221/14/12/P12006.

ATLAS Collaboration.

**Electron reconstruction and identification in the ATLAS experiment using the 2015 and 2016 LHC proton-proton collision data at  $\sqrt{s} = 13$  TeV.**

*The European physical journal / C*, 79(8):639, and PUBDB-2019-03212, arXiv:1902.04655; CERN-EP-2018-273.  
doi: 10.1140/epjc/s10052-019-7140-6.

ATLAS Collaboration.

**Erratum: Search for Resonant and Nonresonant Higgs Boson Pair Production in the  $b\bar{b}\tau^+\tau^-$  Decay Channel in pp Collisions at  $s = 13$  TeV with the ATLAS Detector [Phys. Rev. Lett. 121, 191801 (2018)].**

*Physical review letters*, 122(8):089901, and PUBDB-2020-00495, arXiv:1808.00336; CERN-EP-2018-164.  
doi: 10.1103/PhysRevLett.122.089901.

ATLAS Collaboration.

**Erratum to: Measurement of the W boson polarisation in  $t\bar{t}t\bar{t}$  events from pp collisions at  $\sqrt{s} = 8$  TeV  $s = 8$  TeV in the lepton + jets channel with ATLAS.**

*The European physical journal / C*, 79(1):19, and PUBDB-2020-00502, CERN-EP-2016-219; CERN-PH-2016-219; arXiv:1612.02577.  
doi: 10.1140/epjc/s10052-018-6520-7.

ATLAS Collaboration.

**Erratum to: Measurements of W and Z boson production in pp collisions at  $\sqrt{s} = 5.02$   $s = 5.02$  TeV with the ATLAS detector.**

*The European physical journal / C*, 79(374):15, and PUBDB-2020-00505, arXiv:1810.08424; CERN-EP-2018-259.  
doi: 10.1140/epjc/s10052-019-6870-9.

ATLAS Collaboration.

**Erratum to: Search for supersymmetry in final states with two same-sign or three leptons and jets using 36 fb<sup>-1</sup> of  $s\sqrt{s} = 13$  TeV pp collision data with the ATLAS detector.**

*Journal of high energy physics*, 2019(8):121, and PUBDB-2020-00463, CERN-EP-2017-108; arXiv:1706.03731.  
doi: 10.1007/JHEP08(2019)121.

ATLAS Collaboration.

**Evidence for the production of three massive vector bosons with the ATLAS detector.**

*Physics letters / B*, 798:134913, and PUBDB-2019-04956, arXiv:1903.10415; CERN-EP-2019-041.  
doi: 10.1016/j.physletb.2019.134913.

ATLAS Collaboration.

**Identification of boosted Higgs bosons decaying into b-quark pairs with the ATLAS detector at 13 TeV.**

*The European physical journal / C*, 79(10):836, and PUBDB-2019-05002, arXiv:1906.11005; CERN-EP-2019-085.  
doi: 10.1140/epjc/s10052-019-7335-x.

ATLAS Collaboration.

**In situ calibration of large-radius jet energy and mass in 13 TeV proton–proton collisions with the ATLAS detector.**

*Zeitschrift für Physik / C*, C79(2):135, and PUBDB-2019-03103, arXiv:1807.09477; CERN-EP-2018-191.  
doi: 10.1140/epjc/s10052-019-6632-8.

ATLAS Collaboration.

**Measurement of angular and momentum distributions of charged particles within and around jets in Pb+Pb and pp collisions at  $\sqrt{s_{NN}} = 5.02$  TeV with the ATLAS detector.**

*Physical review / C*, 100(6):064901, and PUBDB-2019-05079, arXiv:1908.05264; CERN-EP-2019-158.  
doi: 10.1103/PhysRevC.100.064901.

ATLAS Collaboration.

**Measurement of distributions sensitive to the underlying event in inclusive Z-boson production in pp collisions at  $\sqrt{s} = 13$  TeV with the ATLAS detector.**

*The European physical journal / C*, 79(8):666, and PUBDB-2019-04975, arXiv:1905.09752; CERN-EP-2019-064.  
doi: 10.1140/epjc/s10052-019-7162-0.

ATLAS Collaboration.

**Measurement of fiducial and differential  $W^+W^-$  production cross-sections at  $\sqrt{s} = 13$  TeV with the ATLAS detector.**

*The European physical journal / C*, 79(10):884, and PUBDB-2019-04967, arXiv:1905.04242; CERN-EP-2019-055.  
doi: 10.1140/epjc/s10052-019-7371-6.

ATLAS Collaboration.

**Measurement of flow harmonics correlations with mean transverse momentum in lead-lead and proton-lead collisions at  $\sqrt{s_{NN}} = 5.02$  TeV with the ATLAS detector.**

*The European physical journal / C*, 79(12):985, and PUBDB-2019-05054, arXiv:1907.05176; CERN-EP-2019-130.  
doi: 10.1140/epjc/s10052-019-7489-6.

ATLAS Collaboration.

**Measurement of jet-substructure observables in top quark, W boson and light jet production in proton-proton collisions at  $\sqrt{s} = 13$  TeV with the ATLAS detector.**

*Journal of high energy physics*, 2019(8):33, and PUBDB-2019-04764, arXiv:1903.02942; CERN-EP-2019-011.  
doi: 10.1007/JHEP08(2019)033.

ATLAS Collaboration.

**Measurement of  $K_S^0$  and  $\Lambda^0$  production in  $t\bar{t}$  dileptonic events in pp collisions at  $\sqrt{s} = 7$  TeV with the ATLAS detector.**

*The European physical journal / C*, 79(12):1017, and PUBDB-2020-00506, arXiv:1907.10862; CERN-EP-2019-112.  
doi: 10.1140/epjc/s10052-019-7512-y.

ATLAS Collaboration.

**Measurement of photon–jet transverse momentum correlations in 5.02 TeV Pb + Pb and pp collisions with ATLAS.**

*Physics letters / B*, 789:167, and PUBDB-2019-03124, arXiv:1809.07280; CERN-EP-2018-196.  
doi: 10.1016/j.physletb.2018.12.023.

ATLAS Collaboration.

**Measurement of prompt photon production in  $\sqrt{s_{NN}} = 8.16$  TeV  $p$ +Pb collisions with ATLAS.**

*Physics letters / B*, 796:230, and PUBDB-2019-03275, arXiv:1903.02209; CERN-EP-2019-002.

doi: 10.1016/j.physletb.2019.07.031.

ATLAS Collaboration.

**Measurement of the cross-section and charge asymmetry of  $W$  bosons produced in proton–proton collisions at  $\sqrt{s} = 8$  TeV with the ATLAS detector.**

*The European physical journal / C*, 79(9):760, and PUBDB-2019-04961, arXiv:1904.05631; CERN-EP-2019-053.

doi: 10.1140/epjc/s10052-019-7199-0.

ATLAS Collaboration.

**Measurement of the four-lepton invariant mass spectrum in 13 TeV proton-proton collisions with the ATLAS detector.**

*Journal of high energy physics*, 1904(04):048, and PUBDB-2019-03216, arXiv:1902.05892; CERN-EP-2018-318.

doi: 10.1007/JHEP04(2019)048.

ATLAS Collaboration.

**Measurement of the inclusive cross-section for the production of jets in association with a  $Z$  boson in proton-proton collisions at 8 TeV using the ATLAS detector.**

*The European physical journal / C*, 79(10):847, and PUBDB-2019-05058, arXiv:1907.06728; CERN-EP-2019-133.

doi: 10.1140/epjc/s10052-019-7321-3.

ATLAS Collaboration.

**Measurement of the inclusive isolated-photon cross section in  $pp$  collisions at  $\sqrt{s} = 13$  TeV using 36  $\text{fb}^{-1}$  of ATLAS data.**

*Journal of high energy physics*, 2019(10):203, and PUBDB-2019-05075, arXiv:1908.02746; CERN-EP-2019-136.

doi: 10.1007/JHEP10(2019)203.

ATLAS Collaboration.

**Measurement of the nuclear modification factor for inclusive jets in Pb+Pb collisions at  $\sqrt{s_{NN}} = 5.02$  TeV with the ATLAS detector.**

*Physics letters / B*, 790:108, and PUBDB-2019-03052, arXiv:1805.05635; CERN-EP-2018-105.

doi: 10.1016/j.physletb.2018.10.076.

ATLAS Collaboration.

**Measurement of the production cross section for a Higgs boson in association with a vector boson in the  $H \rightarrow WW^* \rightarrow \ell\nu\ell\nu$  channel in  $pp$  collisions at  $\sqrt{s} = 13$  TeV with the ATLAS detector.**

*Physics letters / B*, 798:134949, and PUBDB-2019-04954, arXiv:1903.10052; CERN-EP-2019-038.

doi: 10.1016/j.physletb.2019.134949.

ATLAS Collaboration.

**Measurement of the ratio of cross sections for inclusive isolated-photon production in  $pp$  collisions at  $\sqrt{s} = 13$  and 8 TeV with the ATLAS detector.**

*Journal of high energy physics*, 2019(4):93, and PUBDB-2019-03204, arXiv:1901.10075; CERN-EP-2018-340.

doi: 10.1007/JHEP04(2019)093.

ATLAS Collaboration.

**Measurement of the top quark mass in the  $t\bar{t} \rightarrow \text{lepton} + \text{jets}$  channel from  $\sqrt{s} = 8$  TeV ATLAS data and combination with previous results.**

*The European physical journal / C*, 79(4):290, and PUBDB-2019-03126, arXiv:1810.01772; CERN-EP-2018-238.

doi: 10.1140/epjc/s10052-019-6757-9.

ATLAS Collaboration.

**Measurement of the top-quark mass in  $t\bar{t} + 1$ -jet events collected with the ATLAS detector in  $pp$  collisions at  $\sqrt{s} = 8$  TeV.**

*Journal of high energy physics*, 2019(11):150, and PUBDB-2019-04963, arXiv:1905.02302; CERN-EP-2019-059.

doi: 10.1007/JHEP11(2019)150.

ATLAS Collaboration.

**Measurement of the  $t\bar{t}Z$  and  $t\bar{t}W$  cross sections in proton-proton collisions at  $\sqrt{s} = 13$  TeV with the ATLAS detector.**

*Physical review / D*, 99(7):072009, and PUBDB-2019-03203, arXiv:1901.03584; CERN-EP-2018-331.

doi: 10.1103/PhysRevD.99.072009.

ATLAS Collaboration.

**Measurement of  $VH, H \rightarrow b\bar{b}$  production as a function of the vector-boson transverse momentum in 13 TeV  $pp$  collisions with the ATLAS detector.**

*Journal of high energy physics*, 2019(5):141, and PUBDB-2020-00462, arXiv:1903.04618; CERN-EP-2019-019.

doi: 10.1007/JHEP05(2019)141.

ATLAS Collaboration.

**Measurement of  $W^\pm$ -boson and  $Z$ -boson production cross-sections in  $pp$  collisions at  $\sqrt{s} = 2.76$  TeV with the ATLAS detector.**

*The European physical journal / C*, 79(11):901, and PUBDB-2019-05049, arXiv:1907.03567; CERN-EP-2019-095.

doi: 10.1140/epjc/s10052-019-7399-7.

ATLAS Collaboration.

**Measurement of  $W^\pm$  boson production in Pb+Pb collisions at  $\sqrt{s_{NN}} = 5.02$  TeV with the ATLAS detector.**

*The European physical journal / C*, 79(11):935, and PUBDB-2019-05071, arXiv:1907.10414; CERN-EP-2019-123.

doi: 10.1140/epjc/s10052-019-7439-3.

ATLAS Collaboration.

**Measurement of  $W^\pm Z$  production cross sections and gauge boson polarisation in  $pp$  collisions at  $\sqrt{s} = 13$  TeV with the ATLAS detector.**

*The European physical journal / C*, 79(6):535, and PUBDB-2019-03214, arXiv:1902.05759; CERN-EP-2018-327.

doi: 10.1140/epjc/s10052-019-7027-6.

ATLAS Collaboration.

**Measurement of  $Z Z$  production in the  $\ell\bar{\ell}\nu\nu$  final state with the ATLAS detector in  $pp$  collisions at  $\sqrt{s} = 13$  TeV.**

*Journal of high energy physics*, 2019(10):127, and PUBDB-2019-04969, arXiv:1905.07163; CERN-EP-2019-066.

doi: 10.1007/JHEP10(2019)127.



ATLAS Collaboration.

**Measurements of gluon-gluon fusion and vector-boson fusion Higgs boson production cross-sections in the  $H \rightarrow WW^* \rightarrow e\nu\mu\nu$  decay channel in  $pp$  collisions at  $\sqrt{s} = 13$  TeV with the ATLAS detector.**

*Physics letters / B*, B789:508, and PUBDB-2020-00478, arXiv:1808.09054; CERN-EP-2018-212.  
doi: 10.1016/j.physletb.2018.11.064.

ATLAS Collaboration.

**Measurements of inclusive and differential fiducial cross-sections of  $t\bar{t}\gamma$  production in leptonic final states at  $\sqrt{s} = 13$  TeV in ATLAS.**

*Zeitschrift für Physik / C*, 79(5):382, and PUBDB-2019-03191, arXiv:1812.01697; CERN-EP-2018-302.  
doi: 10.1140/epjc/s10052-019-6849-6.

ATLAS Collaboration.

**Measurements of inclusive and differential fiducial cross-sections of  $t\bar{t}$  production with additional heavy-flavour jets in proton-proton collisions at  $\sqrt{s} = 13$  TeV with the ATLAS detector.**

*Journal of high energy physics*, 2019(4):46, and PUBDB-2019-03187, arXiv:1811.12113; CERN-EP-2018-276.  
doi: 10.1007/JHEP04(2019)046.

ATLAS Collaboration.

**Measurements of top-quark pair differential and double-differential cross-sections in the  $\ell^+$ +jets channel with  $pp$  collisions at  $\sqrt{s} = 13$  TeV using the ATLAS detector.**

*The European physical journal / C*, 79(12):1028, and PUBDB-2020-00205, arXiv:1908.07305; CERN-EP-2019-149.  
doi: 10.1140/epjc/s10052-019-7525-6.

ATLAS Collaboration.

**Measurements of  $W$  and  $Z$  boson production in  $pp$  collisions at  $\sqrt{s} = 5.02$  TeV with the ATLAS detector.**

*Zeitschrift für Physik / C*, 79(2):128, and PUBDB-2019-03127, arXiv:1810.08424; CERN-EP-2018-259.  
doi: 10.1140/epjc/s10052-019-6622-x.

ATLAS Collaboration.

**Modelling radiation damage to pixel sensors in the ATLAS detector.**

*Journal of Instrumentation*, 14(06):P06012, and PUBDB-2019-04965, arXiv:1905.03739; CERN-EP-2019-061.  
doi: 10.1088/1748-0221/14/06/P06012.

ATLAS Collaboration.

**Observation of electroweak production of a same-sign  $W$  boson pair in association with two jets in  $pp$  collisions at  $\sqrt{s} = 13$  TeV with the ATLAS detector.**

*Physical review letters*, 123(16):161801, and PUBDB-2019-04993, arXiv:1906.03203; CERN-EP-2019-008.  
doi: 10.1103/PhysRevLett.123.161801.

ATLAS Collaboration.

**Observation of electroweak  $W^\pm Z$  boson pair production in association with two jets in  $pp$  collisions at  $\sqrt{s} = 13$  TeV with the ATLAS detector.**

*Physics letters / B*, 793:469, and PUBDB-2019-03199, arXiv:1812.09740; CERN-EP-2018-286.  
doi: 10.1016/j.physletb.2019.05.012.

ATLAS Collaboration.

**Observation of light-by-light scattering in ultraperipheral Pb+Pb collisions with the ATLAS detector.**

*Physical review letters*, 123(5):052001, and PUBDB-2019-04957, arXiv:1904.03536; CERN-EP-2019-051.  
doi: 10.1103/PhysRevLett.123.052001.

ATLAS Collaboration.

**Performance of top-quark and  $W$ -boson tagging with ATLAS in Run 2 of the LHC.**

*The European physical journal / C*, 79(5):375, and PUBDB-2019-03110, arXiv:1808.07858; CERN-EP-2018-192.  
doi: 10.1140/epjc/s10052-019-6847-8.

ATLAS Collaboration.

**Properties of  $g \rightarrow b\bar{b}$  at small opening angles in  $pp$  collisions with the ATLAS detector at  $\sqrt{s} = 13$  TeV.**

*Physical review / D*, 99(5):052004, and PUBDB-2019-03197, arXiv:1812.09283; CERN-EP-2018-323.  
doi: 10.1103/PhysRevD.99.052004.

ATLAS Collaboration.

**Properties of jet fragmentation using charged particles measured with the ATLAS detector in  $pp$  collisions at  $\sqrt{s} = 13$  TeV.**

*Physical review / D*, 100(5):052011, and PUBDB-2019-05000, arXiv:1906.09254; CERN-EP-2019-090.  
doi: 10.1103/PhysRevD.100.052011.

ATLAS Collaboration.

**Resolution of the ATLAS muon spectrometer monitored drift tubes in LHC Run 2.**

*Journal of Instrumentation*, 14(09):P09011, and PUBDB-2019-05006, arXiv:1906.12226; CERN-EP-2019-091.  
doi: 10.1088/1748-0221/14/09/P09011.

ATLAS Collaboration.

**Search for a heavy charged boson in events with a charged lepton and missing transverse momentum from  $pp$  collisions at  $\sqrt{s} = 13$  TeV with the ATLAS detector.**

*Physical review / D*, 100(5):052013, and PUBDB-2019-04996, arXiv:1906.05609; CERN-EP-2019-100.  
doi: 10.1103/PhysRevD.100.052013.

ATLAS Collaboration.

**Search for a right-handed gauge boson decaying into a high-momentum heavy neutrino and a charged lepton in  $pp$  collisions with the ATLAS detector at  $\sqrt{s} = 13$  TeV.**

*Physics letters / B*, 798:134942, and PUBDB-2019-04962, arXiv:1904.12679; CERN-EP-2019-052.  
doi: 10.1016/j.physletb.2019.134942.

ATLAS Collaboration.

**Search for bottom-squark pair production with the ATLAS detector in final states containing Higgs bosons,  $b$ -jets and missing transverse momentum.**

*Journal of high energy physics*, 2019(12):60, and PUBDB-2019-03026, arXiv:1902.05759.  
doi: 10.1007/JHEP12(2019)060.

ATLAS Collaboration.

**Search for chargino and neutralino production in final states with a Higgs boson and missing transverse momentum at  $\sqrt{s} = 13$  TeV with the ATLAS detector.**

*Physical review / D*, 100(1):012006, and PUBDB-2019-03198, arXiv:1812.09432; CERN-EP-2018-306.  
doi: 10.1103/PhysRevD.100.012006.

ATLAS Collaboration.

**Search for diboson resonances in hadronic final states in  $139 \text{ fb}^{-1}$  of  $pp$  collisions at  $\sqrt{s} = 13$  TeV with the ATLAS detector.**

*Journal of high energy physics*, 2019(9):91, and PUBDB-2019-04998, arXiv:1906.08589; CERN-EP-2019-044.  
doi: 10.1007/JHEP09(2019)091.

ATLAS Collaboration.

**Search for doubly charged scalar bosons decaying into same-sign  $W$  boson pairs with the ATLAS detector.**

*The European physical journal / C*, 79(1):58, and PUBDB-2019-03106, arXiv:1808.01899; CERN-EP-2018-188.  
doi: 10.1140/epjc/s10052-018-6500-y.

ATLAS Collaboration.

**Search for excited electrons singly produced in proton–proton collisions at  $\sqrt{s} = 13$  TeV with the ATLAS experiment at the LHC.**

*The European physical journal / C*, 79(9):803, and PUBDB-2019-04995, arXiv:1906.03204; CERN-EP-2019-021.  
doi: 10.1140/epjc/s10052-019-7295-1.

ATLAS Collaboration.

**Search for four-top-quark production in the single-lepton and opposite-sign dilepton final states in  $pp$  collisions at  $\sqrt{s} = 13$  TeV with the ATLAS detector.**

*Physical review / D*, 99(5):052009, and PUBDB-2019-03128, arXiv:1811.02305; CERN-EP-2018-174.  
doi: 10.1103/PhysRevD.99.052009.

ATLAS Collaboration.

**Search for heavy charged long-lived particles in proton-proton collisions at  $\sqrt{s} = 13$  TeV using an ionisation measurement with the ATLAS detector.**

*Physics letters / B*, 788:96, and PUBDB-2019-03108, arXiv:1808.04095; CERN-EP-2018-198.  
doi: 10.1016/j.physletb.2018.10.055.

ATLAS Collaboration.

**Search for heavy charged long-lived particles in the ATLAS detector in  $36.1 \text{ fb}^{-1}$  of proton-proton collision data at  $\sqrt{s} = 13$  TeV.**

*Physical review / D*, 99(9):092007, and PUBDB-2019-03208, arXiv:1902.01636; CERN-EP-2018-339.  
doi: 10.1103/PhysRevD.99.092007.

ATLAS Collaboration.

**Search for heavy long-lived multicharged particles in proton-proton collisions at  $\sqrt{s} = 13$  TeV using the ATLAS detector.**

*Physical review / D*, 99(5):052003, and PUBDB-2019-03194, arXiv:1812.03673; CERN-EP-2018-284.  
doi: 10.1103/PhysRevD.99.052003.

ATLAS Collaboration.

**Search for heavy Majorana or Dirac neutrinos and right-handed  $W$  gauge bosons in final states with two charged leptons and two jets at  $\sqrt{s} = 13$  TeV with the ATLAS detector.**

*Journal of high energy physics*, 2019(1):16, and PUBDB-2019-03125, arXiv:1809.11105; CERN-EP-2018-199.  
doi: 10.1007/JHEP01(2019)016.

ATLAS Collaboration.

**Search for heavy neutral leptons in decays of  $W$  bosons produced in  $13$  TeV  $pp$  collisions using prompt and displaced signatures with the ATLAS detector.**

*Journal of high energy physics*, 2019(10):265, and PUBDB-2019-04976, arXiv:1905.09787; CERN-EP-2019-071.  
doi: 10.1007/JHEP10(2019)265.

ATLAS Collaboration.

**Search for heavy particles decaying into a top-quark pair in the fully hadronic final state in  $pp$  collisions at  $\sqrt{s} = 13$  TeV with the ATLAS detector.**

*Physical review / D*, 99(9):092004, and PUBDB-2019-03272, arXiv:1902.10077; CERN-EP-2018-350.  
doi: 10.1103/PhysRevD.99.092004.

ATLAS Collaboration.

**Search for Higgs boson decays into a pair of light bosons in the  $b\bar{b}\mu\mu$  final state in  $pp$  collision at  $\sqrt{s} = 13$  TeV with the ATLAS detector.**

*Physics letters / B*, B790:1, and PUBDB-2019-03053, arXiv:1807.00539; CERN-EP-2018-153.  
doi: 10.1016/j.physletb.2018.10.073.

ATLAS Collaboration.

**Search for Higgs boson pair production in the  $b\bar{b}W W^*$  decay mode at  $\sqrt{s} = 13$  TeV with the ATLAS detector.**

*Journal of high energy physics*, 2019(4):92, and PUBDB-2019-03133, arXiv:1811.04671; CERN-EP-2018-237.  
doi: 10.1007/JHEP04(2019)092.

ATLAS Collaboration.

**Search for Higgs boson pair production in the  $W W^{(*)} W W^{(*)}$  decay channel using ATLAS data recorded at  $\sqrt{s} = 13$  TeV.**

*Journal of high energy physics*, 2019(5):124, and PUBDB-2019-03184, arXiv:1811.11028; CERN-EP-2018-227.  
doi: 10.1007/JHEP05(2019)124.

ATLAS Collaboration.

**Search for high-mass dilepton resonances using  $139 \text{ fb}^{-1}$  of  $pp$  collision data collected at  $\sqrt{s} = 13$  TeV with the ATLAS detector.**

*Physics letters / B*, B796:68, and PUBDB-2019-04766, arXiv:1903.06248; CERN-EP-2019-030.  
doi: 10.1016/j.physletb.2019.07.016.

ATLAS Collaboration.

**Search for invisible Higgs boson decays in vector boson fusion at  $\sqrt{s} = 13$  TeV with the ATLAS detector.**

*Physics letters / B*, 793:499, and PUBDB-2019-03123, arXiv:1809.06682; CERN-EP-2018-184.  
doi: 10.1016/j.physletb.2019.04.024.



- ATLAS Collaboration.  
**Search for large missing transverse momentum in association with one top-quark in proton-proton collisions at  $\sqrt{s} = 13$  TeV with the ATLAS detector.**  
*Journal of high energy physics*, 2019(5):41, and PUBDB-2019-03200, arXiv:1812.09743; CERN-EP-2018-301.  
 doi: 10.1007/JHEP05(2019)041.
- ATLAS Collaboration.  
**Search for light resonances decaying to boosted quark pairs and produced in association with a photon or a jet in proton-proton collisions at  $\sqrt{s} = 13$  TeV with the ATLAS detector.**  
*Physics letters / B*, 788:316, and PUBDB-2019-03034, arXiv:1801.08769; CERN-EP-2017-280.  
 doi: 10.1016/j.physletb.2018.09.062.
- ATLAS Collaboration.  
**Search for long-lived neutral particles in  $pp$  collisions at  $\sqrt{s} = 13$  TeV that decay into displaced hadronic jets in the ATLAS calorimeter.**  
*Zeitschrift für Physik / C*, 79(6):481, and PUBDB-2019-03211, arXiv:1902.03094; CERN-EP-2018-351.  
 doi: 10.1140/epjc/s10052-019-6962-6.
- ATLAS Collaboration.  
**Search for long-lived particles in final states with displaced dimuon vertices in  $pp$  collisions at  $\sqrt{s} = 13$  TeV with the ATLAS detector.**  
*Physical review / D*, D99(1):012001, and PUBDB-2019-03107, arXiv:1808.03057; CERN-EP-2018-173.  
 doi: 10.1103/PhysRevD.99.012001.
- ATLAS Collaboration.  
**Search for long-lived particles produced in  $pp$  collisions at  $\sqrt{s} = 13$  TeV that decay into displaced hadronic jets in the ATLAS muon spectrometer.**  
*Physical review / D*, 99(5):052005, and PUBDB-2019-03153, arXiv:1811.07370; CERN-EP-2018-241.  
 doi: 10.1103/PhysRevD.99.052005.
- ATLAS Collaboration.  
**Search for low-mass resonances decaying into two jets and produced in association with a photon using  $pp$  collisions at  $\sqrt{s} = 13$  TeV with the ATLAS detector.**  
*Physics letters / B*, 795:56, and PUBDB-2019-03206, arXiv:1901.10917; CERN-EP-2018-347.  
 doi: 10.1016/j.physletb.2019.03.067.
- ATLAS Collaboration.  
**Search for pair production of Higgs bosons in the  $b\bar{b}b\bar{b}$  final state using proton-proton collisions at  $\sqrt{s} = 13$  TeV with the ATLAS detector.**  
*Journal of high energy physics*, 1901(01):030, and PUBDB-2019-03051, CERN-EP-2018-029; arXiv:1804.06174.  
 doi: 10.1007/JHEP01(2019)030.
- ATLAS Collaboration.  
**Search for scalar resonances decaying into  $\mu^+\mu^-$  in events with and without  $b$ -tagged jets produced in proton-proton collisions at  $\sqrt{s} = 13$  TeV with the ATLAS detector.**  
*Journal of high energy physics*, 1907(07):117, and PUBDB-2019-03033, arXiv:1901.08144; CERN-EP-2018-300.  
 doi: 10.1007/JHEP07(2019)117.
- ATLAS Collaboration.  
**Search for single production of vector-like quarks decaying into  $Wb$  in  $pp$  collisions at  $\sqrt{s} = 13$  TeV with the ATLAS detector.**  
*Journal of high energy physics*, 2019(5):164, and PUBDB-2019-03196, arXiv:1812.07343; CERN-EP-2018-226.  
 doi: 10.1007/JHEP05(2019)164.
- ATLAS Collaboration.  
**Search for squarks and gluinos in final states with hadronically decaying  $\tau$ -leptons, jets, and missing transverse momentum using  $pp$  collisions at  $\sqrt{s} = 13$  TeV with the ATLAS detector.**  
*Physical review / D*, D99(1):012009, and PUBDB-2019-03109, arXiv:1808.06358; CERN-EP-2018-185.  
 doi: 10.1103/PhysRevD.99.012009.
- ATLAS Collaboration.  
**Search for the electroweak diboson production in association with a high-mass dijet system in semileptonic final states in  $pp$  collisions at  $\sqrt{s} = 13$  TeV with the ATLAS detector.**  
*Physical review / D*, D100(3):032007, and PUBDB-2019-04974, arXiv:1905.07714; CERN-EP-2019-072.  
 doi: 10.1103/PhysRevD.100.032007.
- ATLAS Collaboration.  
**Search for the Production of a Long-Lived Neutral Particle Decaying within the ATLAS Hadronic Calorimeter in Association with a  $Z$  Boson from  $pp$  Collisions at  $\sqrt{s} = 13$  TeV.**  
*Physical review letters*, 122(15):151801, and PUBDB-2019-03132, arXiv:1811.02542; CERN-EP-2018-275.  
 doi: 10.1103/PhysRevLett.122.151801.
- ATLAS Collaboration.  
**Search for top-quark decays  $t \rightarrow Hq$  with  $36 \text{ fb}^{-1}$  of  $pp$  collision data at  $\sqrt{s} = 13$  TeV with the ATLAS detector.**  
*Journal of high energy physics*, 2019(5):123, and PUBDB-2019-03201, arXiv:1812.11568; CERN-EP-2018-295.  
 doi: 10.1007/JHEP05(2019)123.
- ATLAS Collaboration.  
**Search for vector-boson resonances decaying to a top quark and bottom quark in the lepton plus jets final state in  $pp$  collisions at  $\sqrt{s} = 13$  TeV with the ATLAS detector.**  
*Physics letters / B*, 788:347, and PUBDB-2019-03105, arXiv:1807.10473; CERN-EP-2018-142.  
 doi: 10.1016/j.physletb.2018.11.032.
- ATLAS Collaboration.  
**Searches for scalar leptoquarks and differential cross-section measurements in dilepton-dijet events in proton-proton collisions at a centre-of-mass energy of  $\sqrt{s} = 13$  TeV with the ATLAS experiment.**  
*The European physical journal / C*, C79(9):733, and PUBDB-2019-03207, arXiv:1902.00377; CERN-EP-2018-262.  
 doi: 10.1140/epjc/s10052-019-7181-x.
- ATLAS Collaboration.  
**Searches for third-generation scalar leptoquarks in  $\sqrt{s} = 13$  TeV  $pp$  collisions with the ATLAS detector.**  
*Journal of high energy physics*, 2019(6):144, and PUBDB-2019-03269, arXiv:1902.08103; CERN-EP-2019-026.  
 doi: 10.1007/JHEP06(2019)144.

ATLAS Collaboration.

**Study of the hard double-parton scattering contribution to inclusive four-lepton production in  $pp$  collisions at  $\sqrt{s} = 8$  TeV with the ATLAS detector.**

*Physics letters / B*, B790:595, and PUBDB-2019-03185, arXiv:1811.11094; CERN-EP-2018-274.  
doi: 10.1016/j.physletb.2019.01.062.

ATLAS Collaboration.

**Study of the rare decays of  $B_s^0$  and  $B^0$  mesons into muon pairs using data collected during 2015 and 2016 with the ATLAS detector.**

*Journal of high energy physics*, 2019(4):98, and PUBDB-2019-03192, arXiv:1812.03017; CERN-EP-2018-291.  
doi: 10.1007/JHEP04(2019)098.

ATLAS Collaboration and CMS Collaboration.

**Combinations of single-top-quark production cross-section measurements and  $|f_{LV}V_{tb}|$  determinations at  $\sqrt{s} = 7$  and 8 TeV with the ATLAS and CMS experiments.**

*Journal of high energy physics*, 1905(05):088, and PUBDB-2019-02805, arXiv:1902.07158; CERN-EP-2019-005.  
doi: 10.1007/JHEP05(2019)088.

D. Britzger et al.

**Tensor Pomeron and low- $x$  deep inelastic scattering.**

*Physical review / D*, 100(11):114007, and PUBDB-2019-05312, DESY 19-002.  
doi: 10.1103/PhysRevD.100.114007.

I. Dawson et al.

**In situ radiation damage studies of optoelectronics in the ATLAS Semiconductor Tracker.**

*Journal of Instrumentation*, 14(07):P07014, and PUBDB-2020-00282.  
doi: 10.1088/1748-0221/14/07/P07014.

R. Diener et al.

**The DESY II Test Beam Facility.**

*Nuclear instruments & methods in physics research / A*, 922:265, and PUBDB-2019-01134, arXiv:1807.09328; DESY-18-111.  
doi: 10.1016/j.nima.2018.11.133.

M. Dyndal et al.

**Probing the photonic content of the proton using photon-induced dilepton production in p+Pb collisions at the LHC.**

*Physical review / D*, 99(11):114008, and PUBDB-2019-03016, arXiv:1901.06305; DESY-19-010.  
doi: 10.1103/PhysRevD.99.114008.

Group, LHC Dark Matter Working.

**LHC Dark Matter Working Group: Next-generation spin-0 dark matter models.**

*Physics of the Dark Universe*, 27:100351, and PUBDB-2020-00468, arXiv:1810.09420; CERN-LPCC-2018-02.  
doi: 10.1016/j.dark.2019.100351.

E. Hanson et al.

**Charged Higgs Bosons in Naturally Aligned Two Higgs Doublet Models at the LHC.**

*Physical review / D*, 100(3):035026, and PUBDB-2020-00296, arXiv:1812.04713; MAN/HEP/2018/005.  
doi: 10.1103/PhysRevD.100.035026.

B. Heinemann and Y. Nir.

**The Higgs program and open questions in particle physics and cosmology.**

*Physics / Uspekhi*, 189(9):920, and PUBDB-2020-00510, arXiv:1905.00382.  
doi: 10.3367/UFNe.2019.05.038568.

Y. Liu et al.

**EUDAQ2—A flexible data acquisition software framework for common test beams.**

*Journal of Instrumentation*, 14(10):P10033, and PUBDB-2019-05639.  
doi: 10.1088/1748-0221/14/10/P10033.

L. Poley et al.

**Mapping the depleted area of silicon diodes using a micro-focused X-ray beam.**

*Journal of Instrumentation*, 14(03):P03024, and PUBDB-2020-00489, arXiv:1809.02667.  
doi: 10.1088/1748-0221/14/03/P03024.

#### Master Thesis

S. M. Jaster-Merz.

**Magnet Characterization and Beam Profile Monitor Development for a Spectrometer at the ARES Linac.**

University of Hamburg, 2019.

J. Neundorf.

**A Novel Estimate of the Multijet background in a Search for Dark Matter Produced in Association with Top Quarks in the ATLAS experiment.**

Universität Hamburg, 2019.

#### Ph.D. Thesis

A. Vishwakarma.

**Cross-section measurement of top quark pair production with additional b-jets in the  $e\mu$  channel at  $\sqrt{s} = 13$  TeV with the ATLAS detector.**

Humboldt-Universität zu Berlin, 2019.

## Belle II

---

#### Published

Belle Collaboration.

**Azimuthal asymmetries of back-to-back  $\pi^\pm - (\pi^0, \eta, \pi^\pm)$  pairs in  $e^+e^-$  annihilation.**

*Physical review / D*, 100(9):092008, and PUBDB-2019-04655, Belle preprint 2019-15, KEK Preprint 2019-21, arXiv:1909.01857.  
doi: 10.1103/PhysRevD.100.092008.

Belle Collaboration.

**Evidence for  $B^+ \rightarrow h_c K^+$  and observation of  $\eta_c(2S) \rightarrow p\bar{p}\pi + \pi^-$ .**

*Physical review / D*, 100(1):012001, and PUBDB-2019-02968, arXiv:1903.06414; Belle Preprint 2019-03; KEK Preprint 2018-89.  
doi: 10.1103/PhysRevD.100.012001.

Belle Collaboration.

**Evidence for the decay  $B^0 \rightarrow p\bar{p}\pi^0$ .**

*Physical review / D*, 99(9):091104, and PUBDB-2019-02586.  
doi: 10.1103/PhysRevD.99.091104.

Belle Collaboration.

**First measurement of the CKM angle  $\phi_3$  with  $B^\pm \rightarrow D(K_S^0 \pi^+ \pi^- \pi^0) K^\pm$  decays.**

*Journal of high energy physics*, 2019(10):178, and PUBDB-2019-04552, Belle Preprint 2019-14, KEK Preprint 2019-19; arxiv:1908.09499.  
doi: 10.1007/JHEP10(2019)178.

Belle Collaboration.

**First Measurements of Absolute Branching Fractions of the  $\Xi_c^0$  Baryon at Belle.**

*Physical review letters*, 122(8):082001, and PUBDB-2019-02584.  
doi: 10.1103/PhysRevLett.122.082001.

Belle Collaboration.

**First measurements of absolute branching fractions of the  $\Xi_c^+$  baryon at Belle.**

*Physical review / D*, 100(3):031101, and PUBDB-2019-03287, arXiv:1904.12093; KEK Preprint 2019-3; Belle Preprint 2019-05.  
doi: 10.1103/PhysRevD.100.031101.

Belle Collaboration.

**Measurement of branching fraction and final-state asymmetry for the  $\bar{B}^0 \rightarrow K_S^0 K^\mp \pi^\pm$  decay.**

*Physical review / D*, 100(1):011101, and PUBDB-2019-02969, arXiv:1904.06835; Belle Preprint 2019-06; KEK Preprint 2019-4.  
doi: 10.1103/PhysRevD.100.011101.

Belle Collaboration.

**Measurement of the branching fraction and time-dependent  $CP$  asymmetry for  $B^0 \rightarrow J/\psi \pi^0$  decays.**

*Physical review / D*, 98(11):112008, and PUBDB-2019-02571, arXiv:1810.01356; Belle Preprint 2018-20; KEK Preprint 2018-29; UCHEP-18-04.  
doi: 10.1103/PhysRevD.98.112008.

Belle Collaboration.

**Measurement of time-dependent  $CP$  violation in  $B^0 \rightarrow K_S^0 \pi^0 \pi^0$  decays.**

*Physical review / D*, 99(1):011102, and PUBDB-2019-02573, arXiv:1810.03336.  
doi: 10.1103/PhysRevD.99.011102.

Belle Collaboration.

**Measurements of branching fraction and direct  $CP$  asymmetry in  $B^\pm \rightarrow K_S^0 K_S^0 K^\pm$  and a search for  $B^\pm \rightarrow K_S^0 K_S^0 \pi^\pm$ .**

*Physical review / D*, 99(3):031102, and PUBDB-2019-02161,

arXiv:1812.10221; Belle Preprint 2018-26; KEK Preprint 2018-83.

doi: 10.1103/PhysRevD.99.031102.

Belle Collaboration.

**Measurements of isospin asymmetry and difference of direct  $CP$  asymmetries in inclusive  $B \rightarrow X_s \gamma$  decays.**

*Physical review / D*, 99(3):032012, and PUBDB-2019-02570, arXiv:1807.04236; BELLE-CONF-1801; Belle Preprint 2018-13; KEK Preprint 2018-19.  
doi: 10.1103/PhysRevD.99.032012.

Belle Collaboration.

**Measurements of the Branching Fractions  $\mathcal{B}(B^- \rightarrow \bar{\Lambda}_c^- \Xi_c'^0)$ ,  $\mathcal{B}(B^- \rightarrow \bar{\Lambda}_c^- \Xi_c(2645)^0)$  and  $\mathcal{B}(B^- \rightarrow \bar{\Lambda}_c^- \Xi_c(2790)^0)$ .**

*Physical review / D*, 100(11):112010, and PUBDB-2020-00278, arXiv:1911.12530.  
doi: 10.1103/PhysRevD.100.112010.

Belle Collaboration.

**Observation of  $\Xi(1620)^0$  and evidence for  $\Xi(1690)^0$  in  $\Xi_c^+ \rightarrow \Xi^- \pi^+ \pi^+$  decays.**

*Physical review letters*, 122(7):072501, and PUBDB-2019-02581, arXiv:1810.06181.  
doi: 10.1103/PhysRevLett.122.072501.

Belle Collaboration.

**Observation of a new structure near 10.75 GeV in the energy dependence of the  $e^+e^- \rightarrow (nS)\pi^+\pi^-$  ( $n = 1, 2, 3$ ) cross sections.**

*Journal of high energy physics*, 2019(10):220, and PUBDB-2019-04543, BELLE-CONF-1903.  
doi: 10.1007/JHEP10(2019)220.

Belle Collaboration.

**Observation of a vector charmoniumlike state in  $e^+e^- \rightarrow D_s^+ D_{s1}^-(2536)^- + c.c.$**

*Physical review / D*, 100(11):111103, and PUBDB-2020-00230, arXiv:1911.00671.  
doi: 10.1103/PhysRevD.100.111103.

Belle Collaboration.

**Observation of  $B^+ \rightarrow p \bar{\Lambda} K^+ K^-$  and  $B^+ \rightarrow \bar{p} \Lambda K^+ K^+$ .**

*Physical review / D*, 99(3):032003, and PUBDB-2019-02295, arXiv:1807.10503; Belle Preprint 2018-15; KEK Preprint 2018-21.  
doi: 10.1103/PhysRevD.99.032003.

Belle Collaboration.

**Observation of Transverse  $\Lambda/\bar{\Lambda}$  Hyperon Polarization in  $e^+e^-$  Annihilation at Belle.**

*Physical review letters*, 122(4):042001, and PUBDB-2019-02296.  
doi: 10.1103/PhysRevLett.122.042001.

Belle Collaboration.

**Observation of  $\tau^- \rightarrow \pi^- \nu_\tau e^+ e^-$  and search for  $\tau^- \rightarrow \pi^- \nu_\tau \mu^+ \mu^-$ .**

*Physical review / D*, 100(7):071101, and PUBDB-2019-04545, Belle preprint 2019-12, KEK Preprint 2019-15, arXiv:1908.09353.  
doi: 10.1103/PhysRevD.100.071101.



Belle Collaboration.

**Search for  $\Omega(2112) \rightarrow K\Xi(1530) \rightarrow K\pi\Xi$  at Belle.**

*Physical review / D*, 100(3):032006, and PUBDB-2019-03290, arXiv:1906.00194; Belle Preprint-2019-10; KEK Preprint-2019-8.

doi: 10.1103/PhysRevD.100.032006.

Belle Collaboration.

**Search for a Light CP-odd Higgs Boson and Low-Mass Dark Matter at the Belle Experiment.**

*Physical review letters*, 122(1):011801, and PUBDB-2019-02568, arXiv:1809.05222; Belle-Preprint-2018-21; KEK-Preprint-2018-30.

doi: 10.1103/PhysRevLett.122.011801.

Belle Collaboration.

**Search for  $B^0 \rightarrow X(3872)\gamma$ .**

*Physical review / D*, 100(1):012002, and PUBDB-2019-02970, arXiv:1905.11718; BELLE-PREPRINT 2019-08; KEK-PREPRINT 2019-6.

doi: 10.1103/PhysRevD.100.012002.

Belle Collaboration.

**Search for CP violation with kinematic asymmetries in the  $D^0 \rightarrow K^+K^-\pi^+\pi^-$  decay.**

*Physical review / D*, 99(1):011104, and PUBDB-2019-02582.

doi: 10.1103/PhysRevD.99.011104.

Belle Collaboration.

**Search for the  $B \rightarrow Y(4260)K$ ,  $Y(4260) \rightarrow J/\psi\pi^+\pi^-$  decays.**

*Physical review / D*, 99(7):071102, and PUBDB-2019-02170, arXiv:1901.06470; Belle Preprint 2019-01; KEK Preprint 2018-85.

doi: 10.1103/PhysRevD.99.071102.

Belle Collaboration.

**Search for the rare decay of  $B^+ \rightarrow \ell^+ \nu \ell' \gamma$  with improved hadronic tagging.**

*Physical review / D*, 98(11):112016, and PUBDB-2019-02583.

doi: 10.1103/PhysRevD.98.112016.

Belle Collaboration.

**Search for  $X(3872)$  and  $X(3915)$  decay into  $\chi_{c1}\pi^0$  in  $B$  decays at Belle.**

*Physical review / D*, 99(11):111101, and PUBDB-2019-02587, arXiv:1904.07015.

doi: 10.1103/PhysRevD.99.111101.

Belle Collaboration.

**The Belle II Physics Book.**

*Progress of theoretical and experimental physics*, 2019(12):123C01, and PUBDB-2020-00344.

doi: 10.1093/ptep/ptz106.

Belle Collaboration.

**Transverse momentum dependent production cross sections of charged pions, kaons and protons produced in inclusive  $e^+e^-$  annihilation at  $\sqrt{s}=10.58$  GeV.**

*Physical review / D*, 99(11):112006, and PUBDB-2019-02585.

doi: 10.1103/PhysRevD.99.112006.

Belle II Collaboration.

**First Measurements of Beam Backgrounds at SuperKEKB.**

*Nuclear instruments & methods in physics research / A*, A914:69, and PUBDB-2020-00476, arXiv:1802.01366; AIDA-2020-PUB-2018-005.

doi: 10.1016/j.nima.2018.05.071.

Belle-II DEPFET, PXD.

**DEPFET pixel detector in the Belle II experiment.**

*Nuclear instruments & methods in physics research / A*, A936:657, and PUBDB-2020-00220.

doi: 10.1016/j.nima.2018.10.048.

Belle-II DEPFET, PXD, SVD.

**The Belle II vertex detector integration.**

*Nuclear instruments & methods in physics research / A*, A936:616, and PUBDB-2020-00316.

doi: 10.1016/j.nima.2018.09.003.

Team, xFitter Developers'.

**Probing the strange content of the proton with charm production in charged current at LHeC.**

*The European physical journal / C*, 79(10):864, and PUBDB-2019-04073.

doi: 10.1140/epjc/s10052-019-7362-7.

E. Waheed et al.

**Measurement of the CKM matrix element  $|V_{cb}|$  from  $B^0 \rightarrow D^{*-} \ell^+ \nu_{\ell}$  at Belle.**

*Physical review / D*, D100(5):052007, and PUBDB-2020-00226, arXiv:1809.03290.

doi: 10.1103/PhysRevD.100.052007.

## CMS

### Published

D. Abercrombie et al.

**Dark Matter Benchmark Models for Early LHC Run-2 Searches: Report of the ATLAS/CMS Dark Matter Forum.**

*Physics of the Dark Universe*, 27:100371, and PUBDB-2020-00471, arXiv:1507.00966; FERMILAB-PUB-15-282-CD.

doi: 10.1016/j.dark.2019.100371.

ATLAS Collaboration and CMS Collaboration.

**Combinations of single-top-quark production cross-section measurements and  $|f_{LV}V_{tb}|$  determinations at  $\sqrt{s} = 7$  and 8 TeV with the ATLAS and CMS experiments.**

*Journal of high energy physics*, 1905(05):088, and PUBDB-2019-02805, arXiv:1902.07158; CERN-EP-2019-005.

doi: 10.1007/JHEP05(2019)088.

A. Bermudez Martinez et al.

**Collinear and TMD parton densities from fits to precision DIS measurements in the parton branching method.**

*Physical review / D*, 99(7):074008, and PUBDB-2019-02099, arXiv:1804.11152; DESY-18-042.

doi: 10.1103/PhysRevD.99.074008.

- A. Bermudez Martinez et al.  
**Production of Z-bosons in the parton branching method.**  
*Physical review / D*, 100(7):074027, and PUBDB-2019-04047, arXiv:1906.00919; DESY-19-087; CERN-TH-2019-095; DESY 19-087.  
 doi: 10.1103/PhysRevD.100.074027.
- E. Blanco et al.  
**Z boson production in proton-lead collisions at the LHC accounting for transverse momenta of initial partons.**  
*Physical review / D*, 100(5):054023, and PUBDB-2019-03493, arXiv:1905.07331; DESY-19-086; DESY 19-086.  
 doi: 10.1103/PhysRevD.100.054023.
- CMS Collaboration.  
**A search for pair production of new light bosons decaying into muons in proton-proton collisions at 13 TeV.**  
*Physics letters / B*, 796:131, and PUBDB-2019-02789, arXiv:1812.00380; CMS-HIG-18-003; CERN-EP-2018-288.  
 doi: 10.1016/j.physletb.2019.07.013.
- CMS Collaboration.  
**An embedding technique to determine  $\tau\tau$  backgrounds in proton-proton collision data.**  
*Journal of Instrumentation*, 14(06):P06032, and PUBDB-2019-02807, arXiv:1903.01216; CMS-TAU-18-001; CERN-EP-2019-012.  
 doi: 10.1088/1748-0221/14/06/P06032.
- CMS Collaboration.  
**Azimuthal separation in nearly back-to-back jet topologies in inclusive 2- and 3-jet events in pp collisions at  $\sqrt{s} = 13$  TeV.**  
*The European physical journal / C*, 79(9):773, and PUBDB-2019-03877, arXiv:1902.04374; CMS-SMP-17-009; CERN-EP-2018-344.  
 doi: 10.1140/epjc/s10052-019-7276-4.
- CMS Collaboration.  
**Centrality and pseudorapidity dependence of the transverse energy density in pPb collisions at  $\sqrt{s_{NN}} = 5.02$  TeV.**  
*Physical review / C*, 100(2):024902, and PUBDB-2019-03405, arXiv:1810.05745; CMS-HIN-14-014; CERN-EP-2018-268.  
 doi: 10.1103/PhysRevC.100.024902.
- CMS Collaboration.  
**Charged-particle angular correlations in XeXe collisions at  $\sqrt{s_{NN}} = 5.44$  TeV.**  
*Physical review / C*, 100(4):044902, and PUBDB-2019-03876, arXiv:1901.07997; CMS-HIN-18-001; CERN-EP-2018-345.  
 doi: 10.1103/PhysRevC.100.044902.
- CMS Collaboration.  
**Combination of CMS searches for heavy resonances decaying to pairs of bosons or leptons.**  
*Physics letters / B*, 798:25, and PUBDB-2019-03937, arXiv:1906.00057; CMS-B2G-18-006; CERN-EP-2019-110.  
 doi: 10.1016/j.physletb.2019.134952.
- CMS Collaboration.  
**Combination of searches for Higgs boson pair production in proton-proton collisions at  $\sqrt{s} = 13$  TeV.**  
*Physical review letters*, 122(12):121803, and PUBDB-2019-02088, arXiv:1811.09689; CMS-HIG-17-030; CERN-EP-2018-292.  
 doi: 10.1103/PhysRevLett.122.121803.
- CMS Collaboration.  
**Erratum to: Search for a new scalar resonance decaying to a pair of Z bosons in proton-proton collisions at  $s = 13$   $\sqrt{s} = 13$  TeV.**  
*Journal of high energy physics*, 2019(3):128, and PUBDB-2020-00455, CMS-HIG-17-012; CERN-EP-2018-009; arXiv:1804.01939.  
 doi: 10.1007/JHEP03(2019)128.
- CMS Collaboration.  
**Evidence for light-by-light scattering and searches for axion-like particles in ultraperipheral PbPb collisions at  $\sqrt{s_{NN}} = 5.02$  TeV.**  
*Physics letters / B*, 797:134826, and PUBDB-2019-03406, arXiv:1810.04602; CMS-FSQ-16-012; CERN-EP-2018-271.  
 doi: 10.1016/j.physletb.2019.134826.
- CMS Collaboration.  
**Inclusive search for supersymmetry in pp collisions at  $\sqrt{s} = 13$  TeV using razor variables and boosted object identification in zero and one lepton final states.**  
*Journal of high energy physics*, 1903(03):031, and PUBDB-2019-02102, arXiv:1812.06302; CMS-SUS-16-017; CERN-EP-2018-307.  
 doi: 10.1007/JHEP03(2019)031.
- CMS Collaboration.  
**Jet shapes of isolated photon-tagged jets in PbPb and pp collisions at  $\sqrt{s_{NN}} = 5.02$  TeV.**  
*Physical review letters*, 122(15):152001, and PUBDB-2019-02063, arXiv:1809.08602; CMS-HIN-18-006; CERN-EP-2018-249.  
 doi: 10.1103/PhysRevLett.122.152001.
- CMS Collaboration.  
**Measurement of associated production of a W boson and a charm quark in proton-proton collisions at  $\sqrt{s} = 13$  TeV.**  
*The European physical journal / C*, 79(3):269, and PUBDB-2019-02090, arXiv:1811.10021; CMS-SMP-17-014; CERN-EP-2018-282.  
 doi: 10.1140/epjc/s10052-019-6752-1.
- CMS Collaboration.  
**Measurement of  $B_s^0$  meson production in pp and PbPb collisions at  $\sqrt{s_{NN}} = 5.02$  TeV.**  
*Physics letters / B*, 796:168, and PUBDB-2019-03407, arXiv:1810.03022; CMS-HIN-17-008; CERN-EP-2018-257.  
 doi: 10.1016/j.physletb.2019.07.014.
- CMS Collaboration.  
**Measurement of differential cross sections for inclusive isolated-photon and photon+jets production in proton-proton collisions at  $\sqrt{s} = 13$  TeV.**  
*The European physical journal / C*, 79(1):20, and PUBDB-2020-00501, arXiv:1807.00782; CMS-SMP-16-003; CERN-EP-2018-167.  
 doi: 10.1140/epjc/s10052-018-6482-9.

CMS Collaboration.

**Measurement of differential cross sections for Z boson pair production in association with jets at  $\sqrt{s} = 8$  and 13 TeV.**

*Physical review / B*, 789:19, and PUBDB-2019-00556, arXiv:1806.11073; CMS-SMP-17-005; CERN-EP-2018-161. doi: 10.1016/j.physletb.2018.11.007.

CMS Collaboration.

**Measurement of electroweak WZ boson production and search for new physics in WZ + two jets events in pp collisions at  $\sqrt{s} = 13$  TeV.**

*Physics letters / B*, 795:281, and PUBDB-2019-02803, arXiv:1901.04060; CMS-SMP-18-001; CERN-EP-2018-333. doi: 10.1016/j.physletb.2019.05.042.

CMS Collaboration.

**Measurement of exclusive  $\rho(770)^0$  photoproduction in ultraperipheral pPb collisions at  $\sqrt{s_{NN}} = 5.02$  TeV.**

*The European physical journal / C*, 79(8):702, and PUBDB-2019-03408, arXiv:1902.01339; CMS-FSQ-16-007; CERN-EP-2018-285. doi: 10.1140/epjc/s10052-019-7202-9.

CMS Collaboration.

**Measurement of exclusive  $\Upsilon$  photoproduction from protons in pPb collisions at  $\sqrt{s_{NN}} = 5.02$  TeV.**

*The European physical journal / C*, 79(3):277, and PUBDB-2019-02065, arXiv:1809.11080; CMS-FSQ-13-009; CERN-EP-2018-225. doi: 10.1140/epjc/s10052-019-6774-8.

CMS Collaboration.

**Measurement of inclusive and differential Higgs boson production cross sections in the diphoton decay channel in proton-proton collisions at  $\sqrt{s} = 13$  TeV.**

*Journal of high energy physics*, 1901(01):183, and PUBDB-2019-02051, CMS-HIG-17-025; CERN-EP-2018-166; arXiv:1807.03825. doi: 10.1007/JHEP01(2019)183.

CMS Collaboration.

**Measurement of inclusive very forward jet cross sections in proton-lead collisions at  $\sqrt{s_{NN}} = 5.02$  TeV.**

*Journal of high energy physics*, 1905(05):043, and PUBDB-2019-02323, arXiv:1812.01691; CMS-FSQ-17-001; CERN-EP-2018-325. doi: 10.1007/JHEP05(2019)043.

CMS Collaboration.

**Measurement of nuclear modification factors of  $\Upsilon(1S)$ ,  $\Upsilon(2S)$ , and  $\Upsilon(3S)$  mesons in PbPb collisions at  $\sqrt{s_{NN}} = 5.02$  TeV.**

*Physics letters / B*, 790:270, and PUBDB-2019-00856, CMS-HIN-16-023; CERN-EP-2018-110; arXiv:1805.09215. doi: 10.1016/j.physletb.2019.01.006.

CMS Collaboration.

**Measurement of prompt  $\psi(2S)$  production cross sections in proton-lead and proton-proton collisions at  $\sqrt{s_{NN}} = 5.02$  TeV.**

*Physics letters / B*, 790:509, and PUBDB-2019-02048, CMS-HIN-16-015; CERN-EP-2018-056; arXiv:1805.02248. doi: 10.1016/j.physletb.2019.01.058.

CMS Collaboration.

**Measurement of the average very forward energy as a function of the track multiplicity at central pseudorapidities in proton-proton collisions at  $\sqrt{s} = 13$  TeV.**

*The European physical journal / C*, 79(11):893, and PUBDB-2019-04489, arXiv:1908.01750; CMS-FSQ-18-001; CERN-EP-2019-146; CMS-FSQ-18-001-003. doi: 10.1140/epjc/s10052-019-7402-3.

CMS Collaboration.

**Measurement of the differential Drell-Yan cross section in proton-proton collisions at  $\sqrt{s} = 13$  TeV.**

*Journal of high energy physics*, 2019(12):59, and PUBDB-2019-05484, arXiv:1812.10529; CMS-SMP-17-001; CERN-EP-2018-320. doi: 10.1007/JHEP12(2019)059.

CMS Collaboration.

**Measurement of the top quark mass in the all-jets final state at  $\sqrt{s} = 13$  TeV and combination with the lepton+jets channel.**

*The European physical journal / C*, 79(4):313, and PUBDB-2019-02109, arXiv:1812.10534; CMS-TOP-17-008; CERN-EP-2018-310. doi: 10.1140/epjc/s10052-019-6788-2.

CMS Collaboration.

**Measurement of the top quark polarization and  $t\bar{t}$  spin correlations using dilepton final states in proton-proton collisions at  $\sqrt{s} = 13$  TeV.**

*Physical review / D*, D100(7):072002, and PUBDB-2019-03693, arXiv:1907.03729; CMS-TOP-18-006; CERN-EP-2019-073. doi: 10.1103/PhysRevD.100.072002.

CMS Collaboration.

**Measurement of the top quark Yukawa coupling from  $t\bar{t}$  kinematic distributions in the lepton+jets final state in proton-proton collisions at  $\sqrt{s} = 13$  TeV.**

*Physical review / D*, D100(7):072007, and PUBDB-2019-03930, arXiv:1907.01590; CMS-TOP-17-004; CERN-EP-2019-119. doi: 10.1103/PhysRevD.100.072007.

CMS Collaboration.

**Measurement of the  $t\bar{t}$  production cross section, the top quark mass, and the strong coupling constant using dilepton events in pp collisions at  $\sqrt{s} = 13$  TeV.**

*The European physical journal / C*, 79(5):368, and PUBDB-2019-02324, arXiv:1812.10505; CMS-TOP-17-001; CERN-EP-2018-317. doi: 10.1140/epjc/s10052-019-6863-8.

CMS Collaboration.

**Measurements of differential Z boson production cross sections in proton-proton collisions at  $\sqrt{s} = 13$  TeV.**

*Journal of high energy physics*, 2019(12):61, and PUBDB-2019-05516, arXiv:1909.04133; CMS-SMP-17-010; CERN-EP-2019-175. doi: 10.1007/JHEP12(2019)061.



- CMS Collaboration.  
**Measurements of properties of the Higgs boson decaying to a W boson pair in pp collisions at  $\sqrt{s} = 13$  TeV.**  
*Physics letters / B*, 791:96, and PUBDB-2019-02049, CMS-HIG-16-042; CERN-EP-2018-141; arXiv:1806.05246.  
 doi: 10.1016/j.physletb.2018.12.073.
- CMS Collaboration.  
**Measurements of the Higgs boson width and anomalous  $HVV$  couplings from on-shell and off-shell production in the four-lepton final state.**  
*Physical review / D*, 99(11):112003, and PUBDB-2019-02801, arXiv:1901.00174; CMS-HIG-18-002; CERN-EP-2018-329.  
 doi: 10.1103/PhysRevD.99.112003.
- CMS Collaboration.  
**Measurements of  $t\bar{t}$  differential cross sections in proton-proton collisions at  $\sqrt{s} = 13$  TeV using events containing two leptons.**  
*Journal of high energy physics*, 1902(02):149, and PUBDB-2019-02796, arXiv:1811.06625; CMS-TOP-17-014; CERN-EP-2018-252.  
 doi: 10.1007/JHEP02(2019)149.
- CMS Collaboration.  
**Non-Gaussian elliptic-flow fluctuations in PbPb collisions at  $\sqrt{s_{NN}} = 5.02$  TeV.**  
*Physics letters / B*, 789:643, and PUBDB-2019-00855, CMS-HIN-16-019; CERN-EP-2017-268; arXiv:1711.05594.  
 doi: 10.1016/j.physletb.2018.11.063.
- CMS Collaboration.  
**Observation of nuclear modifications in  $W^\pm$  boson production in pPb collisions at  $\sqrt{s_{NN}} = 8.16$  TeV.**  
*Physics letters / B*, 2019:135048, and PUBDB-2019-03948, arXiv:1905.01486; CMS-HIN-17-007; CERN-EP-2018-283.  
 doi: 10.1016/j.physletb.2019.135048.
- CMS Collaboration.  
**Observation of prompt  $J/\psi$  meson elliptic flow in high-multiplicity pPb collisions at  $\sqrt{s_{NN}} = 8.16$  TeV.**  
*Physics letters / B*, 791:172, and PUBDB-2019-02066, arXiv:1810.01473; CMS-HIN-18-010; CERN-EP-2018-256.  
 doi: 10.1016/j.physletb.2019.02.018.
- CMS Collaboration.  
**Observation of single top quark production in association with a Z boson in proton-proton collisions at  $\sqrt{s} = 13$  TeV.**  
*Physical review letters*, 122(13):132003, and PUBDB-2019-02101, arXiv:1812.05900; CMS-TOP-18-008; CERN-EP-2018-328.  
 doi: 10.1103/PhysRevLett.122.132003.
- CMS Collaboration.  
**Performance of missing transverse momentum reconstruction in proton-proton collisions at  $\sqrt{s} = 13$  TeV using the CMS detector.**  
*Journal of Instrumentation*, 14(07):P07004, and PUBDB-2019-02808, arXiv:1903.06078; CMS-JME-17-001; CERN-EP-2018-335.  
 doi: 10.1088/1748-0221/14/07/P07004.
- CMS Collaboration.  
**Pseudorapidity distributions of charged hadrons in xenon-xenon collisions at  $\sqrt{s_{NN}} = 5.44$  TeV.**  
*Physics letters / B*, 2019:135049, and PUBDB-2019-03881, arXiv:1902.03603; CMS-HIN-17-006; CERN-EP-2018-294.  
 doi: 10.1016/j.physletb.2019.135049.
- CMS Collaboration.  
**Search for a heavy pseudoscalar boson decaying to a Z and a Higgs boson at  $\sqrt{s} = 13$  TeV.**  
*The European physical journal / C*, 79(7):564, and PUBDB-2019-02806, arXiv:1903.00941; CMS-HIG-18-005; CERN-EP-2018-343.  
 doi: 10.1140/epjc/s10052-019-7058-z.
- CMS Collaboration.  
**Search for a heavy resonance decaying to a top quark and a vector-like top quark in the lepton+jets final state in pp collisions at  $\sqrt{s} = 13$  TeV.**  
*The European physical journal / C*, 79(3):208, and PUBDB-2019-02105, arXiv:1812.06489; CMS-B2G-17-015; CERN-EP-2018-313.  
 doi: 10.1140/epjc/s10052-019-6688-5.
- CMS Collaboration.  
**Search for a light charged Higgs boson decaying to a W boson and a CP-odd Higgs boson in final states with  $e\mu\mu$  or  $\mu\mu\mu$  in proton-proton collisions at  $\sqrt{s} = 13$  TeV.**  
*Physical review letters*, 123(13):131802, and PUBDB-2019-03944, arXiv:1905.07453; CMS-HIG-18-020; CERN-EP-2019-083.  
 doi: 10.1103/PhysRevLett.123.131802.
- CMS Collaboration.  
**Search for a low-mass  $\tau^+\tau^-$  resonance in association with a bottom quark in proton-proton collisions at  $\sqrt{s} = 13$  TeV.**  
*Journal of high energy physics*, 1905(05):210, and PUBDB-2019-02810, arXiv:1903.10228; CMS-HIG-17-014; CERN-EP-2019-035.  
 doi: 10.1007/JHEP05(2019)210.
- CMS Collaboration.  
**Search for a standard model-like Higgs boson in the mass range between 70 and 110 GeV in the diphoton final state in proton-proton collisions at  $\sqrt{s} = 8$  and 13 TeV.**  
*Physics letters / B*, 793:320, and PUBDB-2019-02792, arXiv:1811.08459; CMS-HIG-17-013; CERN-EP-2018-207.  
 doi: 10.1016/j.physletb.2019.03.064.
- CMS Collaboration.  
**Search for a  $W'$  boson decaying to a  $\tau$  lepton and a neutrino in proton-proton collisions at  $\sqrt{s} = 13$  TeV.**  
*Physics letters / B*, 792:107, and PUBDB-2019-02052, arXiv:1807.11421; CMS-EXO-17-008; CERN-EP-2018-202.  
 doi: 10.1016/j.physletb.2019.01.069.
- CMS Collaboration.  
**Search for a  $W'$  boson decaying to a vector-like quark and a top or bottom quark in the all-jets final state.**  
*Journal of high energy physics*, 1903(03):127, and PUBDB-2019-02794, arXiv:1811.07010; CMS-B2G-18-001; CERN-EP-2018-279.  
 doi: 10.1007/JHEP03(2019)127.

- CMS Collaboration.  
**Search for anomalous electroweak production of vector boson pairs in association with two jets in proton-proton collisions at 13 TeV.**  
*Physics letters / B*, 798:37, and PUBDB-2019-03947, arXiv:1905.07445; CMS-SMP-18-006; CERN-EP-2019-089. doi: 10.1016/j.physletb.2019.134985.
- CMS Collaboration.  
**Search for anomalous triple gauge couplings in WW and WZ production in lepton + jet events in proton-proton collisions at  $\sqrt{s} = 13$  TeV.**  
*Journal of high energy physics*, 2019(12):62, and PUBDB-2019-05495, arXiv:1907.08354; CMS-SMP-18-008; CERN-EP-2019-137. doi: 10.1007/JHEP12(2019)062.
- CMS Collaboration.  
**Search for associated production of a Higgs boson and a single top quark in proton-proton collisions at  $\sqrt{s} = 13$  TeV.**  
*Physical review / D*, 99(9):092005, and PUBDB-2019-02791, arXiv:1811.09696; CMS-HIG-18-009; CERN-EP-2018-305. doi: 10.1103/PhysRevD.99.092005.
- CMS Collaboration.  
**Search for charged Higgs bosons in the  $H^\pm \rightarrow \tau^\pm \nu_\tau$  decay channel in proton-proton collisions at  $\sqrt{s} = 13$  TeV.**  
*Journal of high energy physics*, 1907(07):142, and PUBDB-2019-03410, arXiv:1903.04560; CMS-HIG-18-014; CERN-EP-2019-025. doi: 10.1007/JHEP07(2019)142.
- CMS Collaboration.  
**Search for contact interactions and large extra dimensions in the dilepton mass spectra from proton-proton collisions at  $\sqrt{s} = 13$  TeV.**  
*Journal of high energy physics*, 1904(04):114, and PUBDB-2019-02108, arXiv:1812.10443; CMS-EXO-17-025; CERN-EP-2018-326. doi: 10.1007/JHEP04(2019)114.
- CMS Collaboration.  
**Search for dark matter in events with a leptoquark and missing transverse momentum in proton-proton collisions at 13 TeV.**  
*Physics letters / B*, 795:76, and PUBDB-2019-02790, arXiv:1811.10151; CMS-EXO-17-015; CERN-EP-2018-278. doi: 10.1016/j.physletb.2019.05.046.
- CMS Collaboration.  
**Search for dark matter particles produced in association with a top quark pair at  $\sqrt{s} = 13$  TeV.**  
*Physical review letters*, 122(1):011803, and PUBDB-2019-00551, arXiv:1807.06522; CMS-EXO-16-049; CERN-EP-2018-183. doi: 10.1103/PhysRevLett.122.011803.
- CMS Collaboration.  
**Search for dark matter produced in association with a Higgs boson decaying to a pair of bottom quarks in proton-proton collisions at  $\sqrt{s} = 13$  TeV.**  
*The European physical journal / C*, 79(3):280, and PUBDB-2019-02795, arXiv:1811.06562; CMS-EXO-16-050; CERN-EP-2018-287. doi: 10.1140/epjc/s10052-019-6730-7.
- CMS Collaboration.  
**Search for dark matter produced in association with a single top quark or a top quark pair in proton-proton collisions at  $\sqrt{s} = 13$  TeV.**  
*Journal of high energy physics*, 1903(03):141, and PUBDB-2019-02111, arXiv:1901.01553; CMS-EXO-18-010; CERN-EP-2018-311. doi: 10.1007/JHEP03(2019)141.
- CMS Collaboration.  
**Search for dark photons in decays of Higgs bosons produced in association with Z bosons in proton-proton collisions at  $\sqrt{s} = 13$  TeV.**  
*Journal of high energy physics*, 2019(10):139, and PUBDB-2019-03919, arXiv:1908.02699; CMS-EXO-19-007; CERN-EP-2019-159. doi: 10.1007/JHEP10(2019)139.
- CMS Collaboration.  
**Search for excited leptons in  $\ell\ell\gamma$  final states in proton-proton collisions at  $\sqrt{s} = 13$  TeV.**  
*Journal of high energy physics*, 1904(04):015, and PUBDB-2019-02797, arXiv:1811.03052; CMS-EXO-18-004; CERN-EP-2018-280. doi: 10.1007/JHEP04(2019)015.
- CMS Collaboration.  
**Search for heavy Majorana neutrinos in same-sign dilepton channels in proton-proton collisions at  $\sqrt{s} = 13$  TeV.**  
*Journal of high energy physics*, 1901(01):122, and PUBDB-2019-00858, CMS-EXO-17-028; CERN-EP-2018-159; arXiv:1806.10905. doi: 10.1007/JHEP01(2019)122.
- CMS Collaboration.  
**Search for heavy neutrinos and third-generation leptoquarks in hadronic states of two  $\tau$  leptons and two jets in proton-proton collisions at  $\sqrt{s} = 13$  TeV.**  
*Journal of high energy physics*, 1903(03):170, and PUBDB-2019-02087, arXiv:1811.00806; CMS-EXO-17-016; CERN-EP-2018-272. doi: 10.1007/JHEP03(2019)170.
- CMS Collaboration.  
**Search for heavy resonances decaying into two Higgs bosons or into a Higgs boson and a W or Z boson in proton-proton collisions at 13 TeV.**  
*Journal of high energy physics*, 1901(01):051, and PUBDB-2019-00859, arXiv:1808.01365; CMS-B2G-17-006; CERN-EP-2018-182. doi: 10.1007/JHEP01(2019)051.
- CMS Collaboration.  
**Search for Higgs and Z boson decays to  $J/\psi$  or  $\Upsilon$  pairs in proton-proton collisions at  $\sqrt{s} = 13$  TeV Search for Higgs and Z boson decays to  $J/\psi$  or  $\Upsilon$  pairs in the four-muon final state in proton-proton collisions at  $\sqrt{s} = 13$  TeV.**  
*Physics letters / B*, 797:134811, and PUBDB-2019-03941, arXiv:1905.10408; CMS-HIG-18-025; CERN-EP-2019-082. doi: 10.1016/j.physletb.2019.134811.

- CMS Collaboration.  
**Search for Higgs boson pair production in the  $\gamma\gamma\bar{b}b$  final state in pp collisions at  $\sqrt{s} = 13$  TeV.**  
*Physics letters / B*, 788:7, and PUBDB-2018-05796, arXiv:1806.00408; CMS-HIG-17-008; CERN-EP-2017-343.  
 doi: 10.1016/j.physletb.2018.10.056.
- CMS Collaboration.  
**Search for invisible decays of a Higgs boson produced through vector boson fusion in proton-proton collisions at  $\sqrt{s} = 13$  TeV.**  
*Physics letters / B*, 793:520, and PUBDB-2019-02061, arXiv:1809.05937; CMS-HIG-17-023; CERN-EP-2018-139.  
 doi: 10.1016/j.physletb.2019.04.025.
- CMS Collaboration.  
**Search for long-lived particles decaying into displaced jets in proton-proton collisions at  $\sqrt{s} = 13$  TeV.**  
*Physical review / D*, 99(3):032011, and PUBDB-2019-02793, arXiv:1811.07991; CMS-EXO-18-007; CERN-EP-2018-289.  
 doi: 10.1103/PhysRevD.99.032011.
- CMS Collaboration.  
**Search for long-lived particles using nonprompt jets and missing transverse momentum with proton-proton collisions at  $\sqrt{s} = 13$  TeV.**  
*Physics letters / B*, 797:134876, and PUBDB-2019-03411, arXiv:1906.06441; CMS-EXO-19-001; CERN-EP-2019-113.  
 doi: 10.1016/j.physletb.2019.134876.
- CMS Collaboration.  
**Search for low-mass resonances decaying into bottom quark-antiquark pairs in proton-proton collisions at  $\sqrt{s} = 13$  TeV.**  
*Physical review / D*, D99(1):012005, and PUBDB-2020-00494, arXiv:1810.11822; CMS-EXO-17-024; CERN-EP-2018-251.  
 doi: 10.1103/PhysRevD.99.012005.
- CMS Collaboration.  
**Search for MSSM Higgs bosons decaying to  $\mu^+\mu^-$  in proton-proton collisions at  $\sqrt{s} = 13$  TeV.**  
*Physics letters / B*, 798:134992, and PUBDB-2019-03923, arXiv:1907.03152; CMS-HIG-18-010; CERN-EP-2019-109.  
 doi: 10.1016/j.physletb.2019.134992.
- CMS Collaboration.  
**Search for narrow  $H\gamma$  resonances in proton-proton collisions at  $\sqrt{s} = 13$  TeV.**  
*Physical review letters*, 122(8):081804, and PUBDB-2019-02053, arXiv:1808.01257; CMS-EXO-17-019; CERN-EP-2018-200.  
 doi: 10.1103/PhysRevLett.122.081804.
- CMS Collaboration.  
**Search for new physics in top quark production in dilepton final states in proton-proton collisions at  $\sqrt{s} = 13$  TeV.**  
*The European physical journal / C*, 79(11):886, and PUBDB-2019-03957, arXiv:1903.11144; CMS-TOP-17-020; CERN-EP-2019-018.  
 doi: 10.1140/epjc/s10052-019-7387-y.
- CMS Collaboration.  
**Search for nonresonant Higgs boson pair production in the  $\bar{b}b\bar{b}b$  final state at  $\sqrt{s} = 13$  TeV.**  
*Journal of high energy physics*, 1904(04):112, and PUBDB-2019-02085, arXiv:1810.11854; CMS-HIG-17-017; CERN-EP-2018-269.  
 doi: 10.1007/JHEP04(2019)112.
- CMS Collaboration.  
**Search for pair production of first-generation scalar leptoquarks at  $\sqrt{s} = 13$  TeV.**  
*Physical review / D*, 99(5):052002, and PUBDB-2019-02798, arXiv:1811.01197; CMS-EXO-17-009; CERN-EP-2018-265.  
 doi: 10.1103/PhysRevD.99.052002.
- CMS Collaboration.  
**Search for pair production of vectorlike quarks in the fully hadronic final state.**  
*Physical review / D*, 100(7):072001, and PUBDB-2019-03934, arXiv:1906.11903; CMS-B2G-18-005; CERN-EP-2019-129.  
 doi: 10.1103/PhysRevD.100.072001.
- CMS Collaboration.  
**Search for pair-produced three-jet resonances in proton-proton collisions at  $\sqrt{s} = 13$  TeV.**  
*Physical review / D*, 99(1):012010, and PUBDB-2019-02083, arXiv:1810.10092; CMS-EXO-17-030; CERN-EP-2018-247.  
 doi: 10.1103/PhysRevD.99.012010.
- CMS Collaboration.  
**Search for physics beyond the standard model in events with overlapping photons and jets.**  
*Physical review letters*, 123(24):241801, and PUBDB-2019-05500, arXiv:1907.06275; FERMILAB-PUB-19-427-CMS; CMS-B2G-18-007; CERN-EP-2019-135.  
 doi: 10.1103/PhysRevLett.123.241801.
- CMS Collaboration.  
**Search for production of Higgs boson pairs in the four b quark final state using large-area jets in proton-proton collisions at  $\sqrt{s} = 13$  TeV.**  
*Journal of high energy physics*, 1901(01):040, and PUBDB-2019-00860, arXiv:1808.01473; CMS-B2G-17-019; CERN-EP-2018-195.  
 doi: 10.1007/JHEP01(2019)040.
- CMS Collaboration.  
**Search for rare decays of Z and Higgs bosons to  $J/\psi$  and a photon in proton-proton collisions at  $\sqrt{s} = 13$  TeV.**  
*The European physical journal / C*, 79(2):94, and PUBDB-2019-02081, arXiv:1810.10056; CMS-SMP-17-012; CERN-EP-2018-250.  
 doi: 10.1140/epjc/s10052-019-6562-5.
- CMS Collaboration.  
**Search for resonances decaying to a pair of Higgs bosons in the  $\bar{b}b\bar{q}q'\ell\nu$  final state in proton-proton collisions at  $\sqrt{s} = 13$  TeV.**  
*Journal of high energy physics*, 2019(10):125, and PUBDB-2019-03950, arXiv:1904.04193; CMS-B2G-18-008; CERN-EP-2019-056.  
 doi: 10.1007/JHEP10(2019)125.



- CMS Collaboration.  
**Search for resonant production of second-generation sleptons with same-sign dimuon events in proton-proton collisions at  $\sqrt{s} = 13$  TeV.**  
*The European physical journal / C*, 79(4):305, and PUBDB-2019-02089, arXiv:1811.09760; CMS-SUS-17-008; CERN-EP-2018-297.  
 doi: 10.1140/epjc/s10052-019-6800-x.
- CMS Collaboration.  
**Search for resonant  $t\bar{t}$  production in proton-proton collisions at  $\sqrt{s} = 13$  TeV.**  
*Journal of high energy physics*, 1904(04):031, and PUBDB-2019-02068, CMS-B2G-17-017; CERN-EP-2018-254; arXiv:1810.05905.  
 doi: 10.1007/JHEP04(2019)031.
- CMS Collaboration.  
**Search for single production of vector-like quarks decaying to a top quark and a W boson in proton-proton collisions at  $\sqrt{s} = 13$  TeV.**  
*The European physical journal / C*, 79(2):90, and PUBDB-2019-02062, arXiv:1809.08597; CMS-B2G-17-018; CERN-EP-2018-230.  
 doi: 10.1140/epjc/s10052-019-6556-3.
- CMS Collaboration.  
**Search for supersymmetric partners of electrons and muons in proton-proton collisions at  $\sqrt{s} = 13$  TeV.**  
*Physics letters / B*, 790:140, and PUBDB-2019-00857, CMS-SUS-17-009; CERN-EP-2018-132; arXiv:1806.05264.  
 doi: 10.1016/j.physletb.2019.01.005.
- CMS Collaboration.  
**Search for supersymmetry in events with a photon, a lepton, and missing transverse momentum in proton-proton collisions at  $\sqrt{s} = 13$  TeV.**  
*Journal of high energy physics*, 1901(01):154, and PUBDB-2019-02100, arXiv:1812.04066; CMS-SUS-17-012; CERN-EP-2018-277.  
 doi: 10.1007/JHEP01(2019)154.
- CMS Collaboration.  
**Search for supersymmetry in events with a photon, jets, b-jets, and missing transverse momentum in proton-proton collisions at 13 TeV.**  
*The European physical journal / C*, 79(5):444, and PUBDB-2019-02802, arXiv:1901.06726; CMS-SUS-18-002; CERN-EP-2018-353.  
 doi: 10.1140/epjc/s10052-019-6926-x.
- CMS Collaboration.  
**Search for supersymmetry in final states with photons and missing transverse momentum in proton-proton collisions at 13 TeV.**  
*Journal of high energy physics*, 1906(06):143, and PUBDB-2019-02809, arXiv:1903.07070; CMS-SUS-17-011; CERN-EP-2019-040.  
 doi: 10.1007/JHEP06(2019)143.
- CMS Collaboration.  
**Search for supersymmetry in proton-proton collisions at 13 TeV in final states with jets and missing transverse momentum.**  
*Journal of high energy physics*, 1910(10):244, and PUBDB-2019-04490, arXiv:1908.04722; CMS-SUS-19-006; CERN-EP-2019-152.  
 doi: 10.1007/JHEP10(2019)244.
- CMS Collaboration.  
**Search for supersymmetry using Higgs boson to diphoton decays at  $\sqrt{s} = 13$  TeV.**  
*Journal of high energy physics*, 2019(11):109, and PUBDB-2019-05556, arXiv:1908.08500; CMS-SUS-18-007; CERN-EP-2019-171.  
 doi: 10.1007/JHEP11(2019)109.
- CMS Collaboration.  
**Search for supersymmetry with a compressed mass spectrum in the vector boson fusion topology with 1-lepton and 0-lepton final states in proton-proton collisions at  $\sqrt{s} = 13$  TeV.**  
*Journal of high energy physics*, 1908(08):150, and PUBDB-2019-03425, arXiv:1905.13059; CMS-SUS-17-007; CERN-EP-2019-093.  
 doi: 10.1007/JHEP08(2019)150.
- CMS Collaboration.  
**Search for the associated production of the Higgs boson and a vector boson in proton-proton collisions at  $\sqrt{s} = 13$  TeV via Higgs boson decays to  $\tau$  leptons.**  
*Journal of high energy physics*, 1906(06):093, and PUBDB-2019-02787, arXiv:1809.03590; CMS-HIG-18-007; CERN-EP-2018-221.  
 doi: 10.1007/JHEP06(2019)093.
- CMS Collaboration.  
**Search for the Higgs boson decaying to two muons in proton-proton collisions at  $\sqrt{s} = 13$  TeV.**  
*Physical review letters*, 122(2):021801, and PUBDB-2019-00553, arXiv:1807.06325; CMS-HIG-17-019; CERN-EP-2018-165.  
 doi: 10.1103/PhysRevLett.122.021801.
- CMS Collaboration.  
**Search for the production of  $W^{\pm}W^{\pm}W^{\mp}$  events at  $\sqrt{s} = 13$  TeV.**  
*Physical review / D*, 100(1):012004, and PUBDB-2019-03426, arXiv:1905.04246; CMS-SMP-17-013; CERN-EP-2019-074.  
 doi: 10.1103/PhysRevD.100.012004.
- CMS Collaboration.  
**Search for top quark partners with charge 5/3 in the same-sign dilepton and single-lepton final states in proton-proton collisions at  $\sqrt{s} = 13$  TeV.**  
*Journal of high energy physics*, 1903(03):082, and PUBDB-2019-02067, arXiv:1810.03188; CMS-B2G-17-014; CERN-EP-2018-258.  
 doi: 10.1007/JHEP03(2019)082.
- CMS Collaboration.  
**Search for  $t\bar{t}H$  production in the  $H \rightarrow b\bar{b}$  decay channel with leptonic  $t\bar{t}$  decays in proton-proton collisions at  $\sqrt{s} = 13$  TeV.**  
*Journal of high energy physics*, 1903(03):026, and PUBDB-2019-02046, CMS-HIG-17-026; CERN-EP-2018-065;

- arXiv:1804.03682.  
doi: 10.1007/JHEP03(2019)026.
- CMS Collaboration.  
**Search for vector-like leptons in multilepton final states in proton-proton collisions at  $\sqrt{s} = 13$  TeV.**  
*Physical review / D*, D100(5):052003, and PUBDB-2019-03938, arXiv:1905.10853; CMS-EXO-18-005; CERN-EP-2019-088.  
doi: 10.1103/PhysRevD.100.052003.
- CMS Collaboration.  
**Search for vector-like quarks in events with two oppositely charged leptons and jets in proton-proton collisions at  $\sqrt{s} = 13$  TeV.**  
*The European physical journal / C*, 79(4):364, and PUBDB-2019-02325, arXiv:1812.09768; CMS-B2G-17-012; CERN-EP-2018-290.  
doi: 10.1140/epjc/s10052-019-6855-8.
- CMS Collaboration.  
**Studies of beauty suppression via nonprompt  $D^0$  mesons in PbPb collisions at  $\sqrt{s_{NN}} = 5.02$  TeV.**  
*Physical review letters*, 123:022001, and PUBDB-2019-02084, arXiv:1810.11102; CMS-HIN-16-016; CERN-EP-2018-264.  
doi: 10.1103/PhysRevLett.123.022001.
- CMS Collaboration.  
**Study of the  $B^+ \rightarrow J/\psi \Lambda_p$  decay in proton-proton collisions at  $\sqrt{s} = 8$  TeV.**  
*Journal of high energy physics*, 2019(12):38, and PUBDB-2020-00466, arXiv:1907.05461; CMS-BPH-18-005; CERN-EP-2019-128.  
doi: 10.1007/JHEP12(2019)100.
- CMS Collaboration.  
**Study of the underlying event in top quark pair production in pp collisions at 13 TeV.**  
*The European physical journal / C*, 79(2):123, and PUBDB-2019-02050, CMS-TOP-17-015; CERN-EP-2018-177; arXiv:1807.02810.  
doi: 10.1140/epjc/s10052-019-6620-z.
- CMS Collaboration.  
**The DAQ and control system for the CMS Phase-1 pixel detector upgrade.**  
*Journal of Instrumentation*, 14(10):P10017, and PUBDB-2020-00223.  
doi: 10.1088/1748-0221/14/10/P10017.
- M. Guthoff.  
**The new Fast Beam Condition Monitor using poly-crystalline diamond sensors for luminosity measurement at CMS.**  
14th Pisa Meeting on Advanced Detectors, Biodola, Elba (Italy), 27 May 2018 - 2 Jun 2018.  
*Nuclear instruments & methods in physics research / A*, vol. 936:717, and PUBDB-2018-05506.  
North-Holland Publ. Co., Amsterdam.  
doi: 10.1016/j.nima.2018.11.071.
- E. Currás et al.  
**Study of small-cell 3D silicon pixel detectors for the high luminosity LHC.**  
*Nuclear instruments & methods in physics research / A*, A931:127, and PUBDB-2020-00305, arXiv:1806.01435.  
doi: 10.1016/j.nima.2019.04.037.
- M. Deak et al.  
**Calculation of the Z+jet cross section including transverse momenta of initial partons.**  
*Physical review / D*, 99(9):094011, and PUBDB-2019-02373, arXiv:1809.03854; DESY-18-159; CERN-TH-2018-204.  
doi: 10.1103/PhysRevD.99.094011.
- R. Diener et al.  
**The DESY II Test Beam Facility.**  
*Nuclear instruments & methods in physics research / A*, 922:265, and PUBDB-2019-01134, arXiv:1807.09328; DESY-18-111.  
doi: 10.1016/j.nima.2018.11.133.
- Group, LHC Dark Matter Working.  
**LHC Dark Matter Working Group: Next-generation spin-0 dark matter models.**  
*Physics of the Dark Universe*, 27:100351, and PUBDB-2020-00468, arXiv:1810.09420; CERN-LPCC-2018-02.  
doi: 10.1016/j.dark.2019.100351.
- HCAL, CMS.  
**Erratum: Dose rate effects in the radiation damage of the plastic scintillators of the CMS hadron endcap calorimeter.**  
*Journal of Instrumentation*, 14(08):E08001, and PUBDB-2020-00490, arXiv:1608.07267.  
doi: 10.1088/1748-0221/14/08/E08001.
- A. V. Lipatov, M. A. Malyshev and H. Jung.  
**TMD parton shower effects in associated  $\gamma$ + jet production at the LHC.**  
*Physical review / D*, D100(3):034028, and PUBDB-2020-00320, arXiv:1906.10552.  
doi: 10.1103/PhysRevD.100.034028.
- D. Ramirez et al.  
**Study of Zboson production in dilepton channel on pPb collisions at  $\sqrt{S_{NN}} = 5.02$  TeV.**  
*Astronomische Nachrichten*, 18.12.asna.201913714, and PUBDB-2020-00289.  
doi: 10.1002/asna.201913714.
- A. M. Sirunyan et al.  
**Combined measurements of Higgs boson couplings in proton-proton collisions at  $\sqrt{s} = 13$  TeV.**  
*The European physical journal / C*, 79(5):421, and PUBDB-2019-02788, arXiv:1809.10733; CMS-HIG-17-031; CERN-EP-2018-263.  
doi: 10.1140/epjc/s10052-019-6909-y.
- A. M. Sirunyan et al.  
**Constraints on anomalous HVV couplings from the production of Higgs bosons decaying to  $\tau$  lepton pairs.**  
*Physical review / D*, 100(11):112002, and PUBDB-2019-05188, arXiv:1903.06973; CMS-HIG-17-034; CERN-EP-2019-029.  
doi: 10.1103/PhysRevD.100.112002.

- A. M. Sirunyan et al.  
**Measurement and interpretation of differential cross sections for Higgs boson production at  $\sqrt{s} = 13$  TeV.**  
*Physics letters / B*, 792:369, and PUBDB-2019-02107, arXiv:1812.06504; CMS-HIG-17-028; CERN-EP-2018-304.  
 doi: 10.1016/j.physletb.2019.03.059.
- A. M. Sirunyan et al.  
**Measurement of the energy density as a function of pseudorapidity in proton-proton collisions at  $\sqrt{s} = 13$  TeV.**  
*The European physical journal / C*, 79(5):391, and PUBDB-2019-02322, arXiv:1812.04095; CMS-FSQ-15-006; CERN-EP-2018-308.  
 doi: 10.1140/epjc/s10052-019-6861-x.
- A. M. Sirunyan et al.  
**Measurements of the  $pp \rightarrow WZ$  inclusive and differential production cross section and constraints on charged anomalous triple gauge couplings at  $\sqrt{s} = 13$  TeV.**  
*Journal of high energy physics*, 1904(04):122, and PUBDB-2019-02184, arXiv:1901.03428; CMS-SMP-18-002; CERN-EP-2018-322.  
 doi: 10.1007/JHEP04(2019)122.
- A. M. Sirunyan et al.  
**Measurements of triple-differential cross sections for inclusive isolated-photon+jet events in pp collisions at  $\sqrt{s} = 8$  TeV join.**  
*The European physical journal / C*, 79(11):969, and PUBDB-2019-05194, arXiv:1907.08155; CMS-SMP-16-016; CERN-EP-2019-127.  
 doi: 10.1140/epjc/s10052-019-7451-7.
- A. M. Sirunyan et al.  
**Observation of two excited  $B_c^+$  states and measurement of the  $B_c^+(2S)$  mass in pp collisions at  $\sqrt{s} = 13$  TeV.**  
*Physical review letters*, 122(13):132001, and PUBDB-2019-02188, arXiv:1902.00571; CMS-BPH-18-007; CERN-EP-2019-014.  
 doi: 10.1103/PhysRevLett.122.132001.
- A. M. Sirunyan et al.  
**Probing the chiral magnetic wave in p Pb and PbPb collisions at  $\sqrt{s_{NN}} = 5.02$  TeV using charge-dependent azimuthal anisotropies.**  
*Physical review / C*, 100(6):064908, and PUBDB-2020-00265, CMS-HIN-16-0017; CERN-EP-2017-180; arXiv:1708.08901.  
 doi: 10.1103/PhysRevC.100.064908.
- A. M. Sirunyan et al.  
**Search for an exotic decay of the Higgs boson to a pair of light pseudoscalars in the final state with two muons and two b quarks in pp collisions at 13 TeV.**  
*Physics letters / B*, 795:398, and PUBDB-2019-02751, arXiv:1812.06359; CMS-HIG-18-011; CERN-EP-2018-309.  
 doi: 10.1016/j.physletb.2019.06.021.
- A. M. Sirunyan et al.  
**Search for an  $L_\mu - L_\tau$  gauge boson using  $Z \rightarrow 4\mu$  events in proton-proton collisions at  $\sqrt{s} = 13$  TeV.**  
*Physics letters / B*, 792:345, and PUBDB-2019-02321, arXiv:1808.03684; CMS-EXO-18-008; CERN-EP-2018-208.  
 doi: 10.1016/j.physletb.2019.01.072.
- A. M. Sirunyan et al.  
**Search for long-lived particles using delayed photons in proton-proton collisions at  $\sqrt{s} = 13$  TeV.**  
*Physical review / D*, 100(11):112003, and PUBDB-2019-05196, arXiv:1909.06166; CMS-EXO-19-005; CERN-EP-2019-185.  
 doi: 10.1103/PhysRevD.100.112003.
- A. M. Sirunyan et al.  
**Search for low mass vector resonances decaying into quark-antiquark pairs in proton-proton collisions at  $\sqrt{s} = 13$  TeV.**  
*Physical review / D*, D100(11):112007, and PUBDB-2020-00482, arXiv:1909.04114; CMS-EXO-18-012; CERN-EP-2019-176.  
 doi: 10.1103/PhysRevD.100.112007.
- A. M. Sirunyan et al.  
**Search for low-mass quark-antiquark resonances produced in association with a photon at  $\sqrt{s} = 13$  TeV.**  
*Physical review letters*, 123(23):231803, and PUBDB-2019-05189, arXiv:1905.10331; CMS-EXO-17-027; CERN-EP-2019-068.  
 doi: 10.1103/PhysRevLett.123.231803.
- A. M. Sirunyan et al.  
**Search for new particles decaying to a jet and an emerging jet.**  
*Journal of high energy physics*, 1902(02):179, and PUBDB-2019-02082, arXiv:1810.10069; CMS-EXO-18-001; CERN-EP-2018-255.  
 doi: 10.1007/JHEP02(2019)179.
- A. M. Sirunyan et al.  
**Search for new physics in final states with a single photon and missing transverse momentum in proton-proton collisions at  $\sqrt{s} = 13$  TeV.**  
*Journal of high energy physics*, 1902(02):074, and PUBDB-2019-02064, arXiv:1810.00196; CMS-EXO-16-053; CERN-EP-2018-248.  
 doi: 10.1007/JHEP02(2019)074.
- A. M. Sirunyan et al.  
**Search for pair production of second-generation leptoquarks at  $\sqrt{s} = 13$  TeV.**  
*Physical review / D*, 99(3):032014, and PUBDB-2019-02054, arXiv:1808.05082; CMS-EXO-17-003; CERN-EP-2018-218.  
 doi: 10.1103/PhysRevD.99.032014.
- A. M. Sirunyan et al.  
**Search for the pair production of light top squarks in the  $e^\pm \mu^\mp$  final state in proton-proton collisions at  $\sqrt{s} = 13$  TeV.**  
*Journal of high energy physics*, 1903(03):101, and PUBDB-2019-02110, arXiv:1901.01288; CMS-SUS-18-003; CERN-EP-2018-312.  
 doi: 10.1007/JHEP03(2019)101.
- A. M. Sirunyan et al.  
**Search for the production of four top quarks in the single-lepton and opposite-sign dilepton final states in proton-proton collisions at  $\sqrt{s} = 13$  TeV.**  
*Journal of high energy physics*, 2019(11):82, and PUBDB-2019-05192, arXiv:1906.02805; CERN-EP-2019-098.  
 doi: 10.1007/JHEP11(2019)082.



A. M. Sirunyan et al.  
**Search for W boson decays to three charged pions.**  
*Physical review letters*, 122(15):151802, and PUBDB-2019-02185, arXiv:1901.11201; CMS-SMP-18-009; CERN-EP-2019-001.  
doi: 10.1103/PhysRevLett.122.151802.

A. Velyka and H. Jansen.  
**Development and simulations of Enhanced Lateral Drift Sensors.**  
*Journal of Instrumentation*, 14(05):C05005, and PUBDB-2019-02228, DESY-19-081; arXiv:1905.03119.  
doi: 10.1088/1748-0221/14/05/C05005.

#### Master Thesis

J. Ruebenach.  
**Confronting EFT with artificial neural networks in the quest for physics beyond the Standard Model - Probing new paths for measuring dimension-6 operators in top-quark physics at LHC.**  
University of Hamburg, Hamburg, 2019.

M. V. Schmitz.  
**Drell-Yan Production with Transverse Momentum Dependent Parton Densities.**  
University of Hamburg, 2019.

#### Ph.D. Thesis

A. A. Anuar.  
**Top Quark Spin and Polarization Properties in Searches for New Phenomena with the CMS Detector at the LHC.**  
Universität Hamburg, Hamburg, 2019.

I. Babounikau.  
**Search for supersymmetry with tau leptons in the CMS experiment.**  
Universität Hamburg, Hamburg, 2019.

A. Bermudez Martinez.  
**Measurement and phenomenology of azimuthal correlations in high transverse momentum multi-jet topologies in CMS at the center-of-mass energy of 13 TeV.**  
Universität Hamburg, Hamburg, 2019.

V. Botta.  
**Measurement of the coupling strength of the Higgs boson to  $\tau$  leptons with the CMS experiment at the LHC.**  
Universität Hamburg, Hamburg, 2019.

S. Pflitsch.  
**Associated Production of W + Charm in 13 TeV Proton-Proton Collisions Measured with CMS and Determination of the Strange Quark Content of the Proton.**  
Universität Hamburg, Hamburg, 2019.

P. Schütze.  
**Silicon Pixel Detectors - Performance after Irradiation and Application in Three-dimensional Imaging.**  
Universität Hamburg, Hamburg, 2019.

R. Shevchenko.  
**Search for high mass higgs bosons in the final state with b-quarks with the CMS 2016 data.**  
Universität Hamburg, Hamburg, 2019.

A. Till.  
**Precision measurement of the top quark pair production cross section at  $\sqrt{s} = 13$  TeV with the CMS detector.**  
Hamburg University, 2019.

Y. Wen.  
**Tau Lepton: As a Tool for Hunting Standard Model and Beyond Standard Model Higgs.**  
Universität Hamburg, Hamburg, 2019.

## Electronics Development

---

#### Published

A. Allahgholi et al.  
**Megapixels @ Megahertz – The AGIPD high-speed cameras for the European XFEL.**  
Ultrafast Imaging, Tracking Instrumentation, Methods and Applications Forum 2018, Argonne, IL (USA), 11 Sep 2018 - 14 Sep 2018.  
*Nuclear instruments & methods in physics research / A*, vol. 942:162324, and PUBDB-2019-04730.  
North-Holland Publ. Co., Amsterdam.  
doi: 10.1016/j.nima.2019.06.065.

A. Allahgholi et al.  
**The Adaptive Gain Integrating Pixel Detector at the European XFEL.**  
*Journal of synchrotron radiation*, 26(1):74, and PUBDB-2019-01075.  
doi: 10.1107/S1600577518016077.

K. Hansen et al.  
**Qualification and integration aspects of the DSSC mega-pixel X-ray imager.**  
*IEEE transactions on nuclear science*, 66(8):1966, and PUBDB-2019-02684.  
doi: 10.1109/TNS.2019.2927421.

## HERMES

---

#### Published

A. Airapetian et al.  
**Beam-helicity asymmetries for single-hadron production in semi-inclusive deep-inelastic scattering from unpolarized hydrogen and deuterium targets.**  
*Physics letters / B*, 797:134886, and PUBDB-2019-03298, DESY 19-040, arXiv:1903.08544.  
doi: 10.1016/j.physletb.2019.134886.

HERMES Collaboration.

**Longitudinal double-spin asymmetries in semi-inclusive deep-inelastic scattering of electrons and positrons by protons and deuterons.**

*Physical review / D*, 99(11):112001, and PUBDB-2019-03264, DESY-18-181; arXiv:1810.07054.  
doi: 10.1103/PhysRevD.99.112001.

## Linear Collider

---

### Published

H. Abramowicz et al.

**Top-quark physics at the CLIC electron-positron linear collider.**  
*Journal of high energy physics*, 2019(11):3, and PUBDB-2019-05135, CLICdp-Pub-2018-003.  
doi: 10.1007/JHEP11(2019)003.

M. Chefdeville et al.

**Analysis of testbeam data of the highly granular RPC-steel CALICE digital hadron calorimeter and validation of Geant4 Monte Carlo models.**

*Nuclear instruments & methods in physics research / A*, 939:89, and PUBDB-2019-05612, arXiv:1901.08818.  
doi: 10.1016/j.nima.2019.05.013.

S. J. D. Dann et al.

**Laser wakefield acceleration with active feedback at 5 Hz.**  
*Physical review accelerators and beams*, 22(4):041303, and PUBDB-2019-04796.  
doi: 10.1103/PhysRevAccelBeams.22.041303.

R. D'Arcy et al.

**Tunable Plasma-Based Energy Dechirper.**  
*Physical review letters*, 122(3):034801, and PUBDB-2019-00950.  
doi: 10.1103/PhysRevLett.122.034801.

R. D'Arcy et al.

**FLASHForward: plasma wakefield accelerator science for high-average-power applications.**  
*Philosophical transactions of the Royal Society of London / A*, 377(2151):20180392, and PUBDB-2019-04237, arXiv:1905.03693.  
doi: 10.1098/rsta.2018.0392.

A. Deng et al.

**Generation and acceleration of electron bunches from a plasma photocathode.**  
*Nature physics*, 15(11):1156, and PUBDB-2019-04616.  
doi: 10.1038/s41567-019-0610-9.

S. Diederichs et al.

**Positron transport and acceleration in beam-driven plasma wakefield accelerators using plasma columns.**  
*Physical review accelerators and beams*, 22(8):081301, and PUBDB-2019-04018.  
doi: 10.1103/PhysRevAccelBeams.22.081301.

R. Diener et al.

**The DESY II Test Beam Facility.**  
*Nuclear instruments & methods in physics research / A*, 922:265, and PUBDB-2019-01134, arXiv:1807.09328; DESY-18-111.  
doi: 10.1016/j.nima.2018.11.133.

G. Eigen et al.

**Characterisation of different stages of hadronic showers using the CALICE Si-W ECAL physics prototype.**  
*Nuclear instruments & methods in physics research / A*, 937:41, and PUBDB-2019-05611, arXiv:1902.06161.  
doi: 10.1016/j.nima.2019.04.111.

B. Hidding et al.

**Fundamentals and Applications of Hybrid LWFA-PWFA.**  
*Applied Sciences*, 9(13):2626, and PUBDB-2019-04617.  
doi: 10.3390/app9132626.

C.-S. Jao et al.

**Preliminary Study for the Laboratory Experiment of Cosmic-Rays driven Magnetic Field Amplification.**  
*High energy density physics*, 32:31, and PUBDB-2019-02938.  
doi: 10.1016/j.hedp.2019.04.001.

M. Kobayashi et al.

**Measurement of the electron transmission rate of the gating foil for the TPC of the ILC experiment.**  
*Nuclear instruments & methods in physics research / A*, 918:41, and PUBDB-2019-04702.  
doi: 10.1016/j.nima.2018.11.060.

C. A. Lindstroem et al.

**Erratum: Emittance Preservation in an Aberration-Free Active Plasma Lens.**  
*Physical review letters*, 122(12):129901, and PUBDB-2019-04798.  
doi: 10.1103/PhysRevLett.122.129901.

G. G. Manahan et al.

**Advanced schemes for underdense plasma photocathode wakefield accelerators: pathways towards ultrahigh brightness electron beams.**  
2151. Directions in particle beam-driven plasma wakefield acceleration, Kavli Royal Society Centre, Chicheley Hall, Newport Pagnell, Buckinghamshire, MK16 9JJ (United Kingdom), 4 Jun 2018 - 5 Jun 2018.  
*Philosophical transactions of the Royal Society of London / A*, vol. 3772151:20180182, and PUBDB-2019-04618.  
London.  
doi: 10.1098/rsta.2018.0182.

A. Martinez de la Ossa et al.

**Hybrid LWFA-PWFA staging as a beam energy and brightness transformer: conceptual design and simulations.**  
*Philosophical transactions of the Royal Society of London / A*, 377(2151):20180175, and PUBDB-2019-04795.  
doi: 10.1098/rsta.2018.0175.

J.-P. Schwinkendorf et al.

**Charge calibration of DRZ scintillation phosphor screens.**  
*Journal of Instrumentation*, 14(09):P09025, and PUBDB-2019-04565.  
doi: 10.1088/1748-0221/14/09/P09025.

F. Sefkow and F. Simon.

**A highly granular SiPM-on-tile calorimeter prototype.**

18th International Conference on Calorimetry in Particle Physics (CALOR 2018), Eugene, OR (USA), 21 May 2018 - 25 May 2018.

*Journal of physics / Conference series*, vol. 1162:012012, and PUBDB-2019-05652.

IOP Publ.20382, Bristol.

doi: 10.1088/1742-6596/1162/1/012012.

G. D. L. Semione et al.

**Niobium near-surface composition during nitrogen infusion relevant for superconducting radio-frequency cavities.**

*Physical review accelerators and beams*, 22(10):103102, and PUBDB-2019-04335.

doi: 10.1103/PhysRevAccelBeams.22.103102.

M. Wenskat.

**First Attempts in Automated Defect Recognition in Superconducting Radio-Frequency Cavities.**

*Journal of Instrumentation*, 14(3):P06021, and PUBDB-2019-02509.

doi: 10.1088/1748-0221/14/06/P06021.

## Master Thesis

S. Diederichs.

**Positron Acceleration with Beam-Driven Plasma Wakefield Accelerators.**

University of Hamburg, 2019.

## Ph.D. Thesis

A. Aschikhin.

**Numerical beam stability studies in external injection plasma-wakefield acceleration regimes.**

Universität Hamburg, Hamburg, 2019.

R. Karl.

**From the Machine-Detector Interface to Electroweak Precision Measurements at the ILC — Beam-Gas Background, Beam Polarization and Triple Gauge Couplings.**

Universität Hamburg, Hamburg, 2019.

J.-P. Schwinkendorf.

**Electron-beam diagnostics for a laser-driven plasma wakefield accelerator in the framework of FLASHForward.**

Universität Hamburg, Hamburg, 2019.

## Theory

---

### Published

A. Abada et al.

**FCC Physics Opportunities.**

*Zeitschrift für Physik / C*, 79(6):474, and PUBDB-2019-02731, CERN-ACC-2018-0056.

doi: 10.1140/epjc/s10052-019-6904-3.

A. Abada et al.

**Low-scale leptogenesis with three heavy neutrinos.**

*Journal of high energy physics*, 1901(01):164, and PUBDB-2019-00959, arXiv:1810.12463; DESY-18-174; CP3-18-59; LPT-Orsay-18-85.

doi: 10.1007/JHEP01(2019)164.

H. Abe, M. Ishida and Y. Tatsuta.

**Effects of localized  $\mu$ -terms at the fixed points in magnetized orbifold models.**

*Nuclear physics / B*, 947:114732, and PUBDB-2019-03745, DESY-18-092.

doi: 10.1016/j.nuclphysb.2019.114732.

T. Abe and R. Sato.

**Current status and future prospects of the singlet-doublet dark matter model with  $CP$  violation.**

*Physical review / D*, 99(3):035012, and PUBDB-2019-01992, arXiv:1901.02278; DESY-19-003.

doi: 10.1103/PhysRevD.99.035012.

T. Abe et al.

**Indirect studies of electroweakly interacting particles at 100 TeV hadron colliders.**

*Physical review / D*, 100(5):055018, and PUBDB-2019-03753, arXiv:1904.11162; UT-19-09; DESY-19-069.

doi: 10.1103/PhysRevD.100.055018.

J. Ablinger et al.

**Numerical implementation of harmonic polylogarithms to weight  $w = 8$ .**

*Computer physics communications*, 240:189, and PUBDB-2019-02485.

doi: 10.1016/j.cpc.2019.02.005.

A. H. Ajjath et al.

**Higgs pair production from bottom quark annihilation to NNLO in QCD.**

*Journal of high energy physics*, 2019(5):30, and PUBDB-2020-00460, arXiv:1811.01853; IJScI/2018/11/09; DESY-18-166; TIF-UNIMI-2018-9.

doi: 10.1007/JHEP05(2019)030.

A. H. Ajjath et al.

**Resummed prediction for Higgs boson production through  $b\bar{b}$  annihilation at  $N^3LL$ .**

*Journal of high energy physics*, 2019(11):6, and PUBDB-2019-04349, DESY-19-076.

doi: 10.1007/JHEP11(2019)006.

I. Akal.

**Super Gaussian enhancers in the Schwinger mechanism.**

*Communications in theoretical physics*, 72(1):015201, and PUBDB-2020-00449, DESY-17-224.

doi: 10.1088/1572-9494/ab5450.

A. Albert et al.

**Recommendations of the LHC Dark Matter Working Group: Comparing LHC searches for dark matter mediators in visible and invisible decay channels and calculations of the thermal relic density.**

*Physics of the Dark Universe*, 26:19, and PUBDB-2020-00217, CERN-LPCC-2017-01; arXiv:1703.05703.

doi: 10.1016/j.dark.2019.100377.



- C. Alexandrou et al.  
**Systematic uncertainties in parton distribution functions from lattice QCD simulations at the physical point.**  
*Physical review / D*, 99(11):114504, and PUBDB-2019-02720, arXiv:1902.00587; DESY-19-001.  
doi: 10.1103/PhysRevD.99.114504.
- C. Alexandrou et al.  
**Proton and neutron electromagnetic form factors from lattice QCD.**  
*Physical review / D*, 100(1):014509, and PUBDB-2020-00239, arXiv:1812.10311; DESY-18-033; DESY 18-033.  
doi: 10.1103/PhysRevD.100.014509.
- A. Ali and A. Y. Parkhomenko.  
**Interpretation of the Narrow  $J/\psi p$  Peaks in  $\Lambda_b \rightarrow J/\psi p K^-$  Decay in the Compact Diquark Model.**  
*Physics letters / B*, 793:365, and PUBDB-2019-02498, arXiv:1904.00446; DESY-19-051.  
doi: 10.1016/j.physletb.2019.05.002.
- A. Ali et al.  
**Interpretation of  $Y(10750)$  as a tetraquark and its production mechanism.**  
*Physics letters / B*, 802:135217, and PUBDB-2020-00618, DESY-19-164.  
doi: 10.1016/j.physletb.2020.135217.
- A. Ali et al.  
**Mass spectrum of the hidden-charm pentaquarks in the compact diquark model.**  
*Journal of high energy physics*, 2019(10):256, and PUBDB-2019-04346, arXiv:1907.06507; DESY-19-052.  
doi: 10.1007/JHEP10(2019)256.
- S. Ali et al.  
**Numerical results for the lightest bound states in  $\mathcal{N} = 1$  supersymmetric SU(3) Yang-Mills theory.**  
*Physical review letters*, 122(22):221601, and PUBDB-2020-00496, arXiv:1902.11127; MS-TP-19-04.  
doi: 10.1103/PhysRevLett.122.221601.
- S. Ali et al.  
**Variational analysis of low-lying states in supersymmetric Yang-Mills theory.**  
*Journal of high energy physics*, 1904(4):150, and PUBDB-2020-00458, arXiv:1901.02416; MS-TP-19-01.  
doi: 10.1007/JHEP04(2019)150.
- J. R. Andersen et al.  
**Finite quark-mass effects in Higgs boson production with dijets at large energies.**  
*Journal of high energy physics*, 1904(04):127, and PUBDB-2019-02271, arXiv:1812.08072; DESY-18-217; DCPT/18/204; IPPP/18/102; MCnet-18-33.  
doi: 10.1007/JHEP04(2019)127.
- J. R. Andersen et al.  
**HEJ 2: High Energy Resummation for Hadron Colliders.**  
*Computer physics communications*, 245:106832, and PUBDB-2020-00209, arXiv:1902.08430; DESY 19-028; DESY-19-028; IPPP/19/13; MCnet-19-05.  
doi: 10.1016/j.cpc.2019.06.022.
- G. Arias-Tamargo et al.  
**Discrete gauge theories of charge conjugation.**  
*Nuclear physics*, 946:114721, and PUBDB-2019-03248, DESY-19-045; arXiv:1903.06662.  
doi: 10.1016/j.nuclphysb.2019.114721.
- N. Asmussen et al.  
**Hadronic light-by-light scattering in the anomalous magnetic moment of the muon.**  
15th International Workshop on Tau Lepton Physics, Amsterdam (The Netherlands), 24 Sep 2018 - 28 Sep 2018.  
*SciPost physics*, vol. 1:031, and PUBDB-2020-00087.  
SciPost Foundation, Amsterdam.  
doi: 10.21468/SciPostPhysProc.1.031.
- A. Athenodorou et al.  
**How perturbative are heavy sea quarks?**  
*Nuclear physics / B*, 943:114612, and PUBDB-2019-02113, DESY-18-134; HU-EP-18-28; WUB-18-03; arXiv:1809.03383.  
doi: 10.1016/j.nuclphysb.2019.114612.
- P. Athron et al.  
**Global analyses of Higgs portal singlet dark matter models using GAMBIT 1434-6044.**  
*The European physical journal / C*, 79(1):38, and PUBDB-2019-00957, CoEPP-MN-18-6; DESY-18-141; TTK-18-34; ADP-18-22-T1070; arXiv:1808.10465.  
doi: 10.1140/epjc/s10052-018-6513-6.
- D. Azevedo et al.  
**Models with Extended Higgs Sectors at Future  $e^+e^-$  Colliders.**  
*Physical review / D*, 99(5):055013, and PUBDB-2019-01969, arXiv:1808.00755; KA-TP-20-2018; DESY-18-130.  
doi: 10.1103/PhysRevD.99.055013.
- E. Bagnaschi et al.  
**Global analysis of dark matter simplified models with leptophobic spin-one mediators using MasterCode.**  
*The European physical journal / C*, 79(11):895, and PUBDB-2019-04348, arXiv:1905.00892; KCL-PH-T-2019-10; CERN-TH-2019-007; DESY-19-071; PSI-PR-19-06; IFT-UAM/CSIC-18-2120; FTPI-MINN-19/05; UMN-TH-3814/19.  
doi: 10.1140/epjc/s10052-019-7382-3.
- E. Bagnaschi et al.  
**MSSM Higgs boson searches at the LHC: benchmark scenarios for Run 2 and beyond.**  
*The European physical journal / C*, 79(7):617, and PUBDB-2019-02905, DESY-18-140; MPP-2018-211; KA-TP-25-2018; IFT-UAM/CSIC-18-017; EFI-18-12; arXiv:1808.07542.  
doi: 10.1140/epjc/s10052-019-7114-8.
- E. Bagnaschi et al.  
**Supersymmetric models in light of improved Higgs mass calculations.**  
*The European physical journal / C*, 79(2):149, and PUBDB-2019-01983, DESY-18-182; CERN-TH-2018-185; PSI-PR-18-11; UMN-TH-3801-18; FTPI-MINN-18-18; IFT-UAM-CSIC-18-081; KIAS-P18095; KCL-PH-TH-2018-41; MPP-2018-239; CP3-Origins-2018-039 DNRf90; arXiv:1810.10905.  
doi: 10.1140/epjc/s10052-019-6658-y.

- H. Bahl.  
**Pole mass determination in presence of heavy particles.**  
*Journal of high energy physics*, 1902(02):121, and PUBDB-2019-01985, DESY-18-188; MPP-2018-240; arXiv:1812.06452.  
doi: 10.1007/JHEP02(2019)121.
- H. Bahl, S. Liebler and T. Stefaniak.  
**MSSM Higgs Benchmark Scenarios for Run 2 and Beyond: the low  $\tan\beta$  region.**  
*The European physical journal / C*, 79(3):279, and PUBDB-2019-01989, arXiv:1901.05933; DESY-18-219; KA-TP-01-2019.  
doi: 10.1140/epjc/s10052-019-6770-z.
- F. Bahr et al.  
**Extraction of bare form factors for  $B_s \rightarrow K\ell\nu$  decays in nonperturbative HQET.**  
*International journal of modern physics / A*, 34(28):1950166, and PUBDB-2020-00054, arXiv:1903.05870; DESY-19-030.  
doi: 10.1142/S0217751X19501665.
- I. Baldes and C. Garcia-Cely.  
**Strong gravitational radiation from a simple dark matter model.**  
*Journal of high energy physics*, 1905(05):190, and PUBDB-2019-02500, DESY-18-155; arXiv:1809.01198.  
doi: 10.1007/JHEP05(2019)190.
- G. Ballesteros et al.  
**Several Problems in Particle Physics and Cosmology Solved in One SMASH.**  
*Frontiers in astronomy and space sciences*, 6:55, and PUBDB-2019-03251, arXiv:1904.05594; DESY-19-056; IFT-UAM/CSIC-19-39; MPP-2019-75; TUM-HEP-1196-19.  
doi: 10.3389/fspas.2019.00055.
- N. Bar et al.  
**Ultralight dark matter in disk galaxies.**  
*Physical review / D*, 99(10):103020, and PUBDB-2019-02911, DESY-19-036; arXiv:1903.03402.  
doi: 10.1103/PhysRevD.99.103020.
- T. Bargheer, F. Coronado and P. Vieira.  
**Octagons I: Combinatorics and Non-Planar Resummations.**  
*Journal of high energy physics*, 1908(8):162, and PUBDB-2020-00298, arXiv:1904.00965.  
doi: 10.1007/JHEP08(2019)162.
- S. Basnet et al.  
**Exclusive  $\pi^+$  electroproduction off the proton from low to high- $t$ .**  
*Physical review / C*, C100(6):065204, and PUBDB-2020-00287, arXiv:1911.11681.  
doi: 10.1103/PhysRevC.100.065204.
- D. Baumann, H. S. Chia and R. A. Porto.  
**Probing ultralight bosons with binary black holes.**  
*Physical review / D*, 99(4):044001, and PUBDB-2019-01975, DESY-18-060; arXiv:1804.03208.  
doi: 10.1103/PhysRevD.99.044001.
- A. Behring et al.  
**The polarized three-loop anomalous dimensions from on-shell massive operator matrix elements.**  
*Nuclear physics / B*, 948:41, and PUBDB-2019-03927, arXiv:1908.03779; DESY-19-118.  
doi: 10.1016/j.nuclphysb.2019.114753.
- G. Bell, R. Rahn and J. Talbert.  
**Generic dijet soft functions at two-loop order: correlated emissions.**  
*Journal of high energy physics*, 1907(07):101, and PUBDB-2019-02906, DESY-18-209; arXiv:1812.08690.  
doi: 10.1007/JHEP07(2019)101.
- G. Bell et al.  
 **$e^+e^-$  angularity distributions at NNLL' accuracy.**  
*Journal of high energy physics*, 1901(01):147, and PUBDB-2019-00956, DESY-18-083; SI-HEP-2018-19; LA-UR-18-24071; arXiv:1808.07867.  
doi: 10.1007/JHEP01(2019)147.
- M. Bernardes Pereira de Figueiredo Dias, J. Frazer and A. Westphal.  
**Inflation as an information bottleneck: a strategy for identifying universality classes and making robust predictions.**  
*Journal of high energy physics*, 1905(05):065, and PUBDB-2019-02501, arXiv:1810.05199; DESY-18-177.  
doi: 10.1007/JHEP05(2019)065.
- M. Bernardes Pereira de Figueiredo Dias et al.  
**Primordial Gravitational Waves and the Swampland.**  
*Fortschritte der Physik*, 67(1-2):1800063, and PUBDB-2019-01977, DESY-18-125; arXiv:1807.06579.  
doi: 10.1002/prop.201800063.
- J. M. Bickerton et al.  
**Patterns of flavor symmetry breaking in hadron matrix elements involving  $u$ ,  $d$ , and  $s$  quarks.**  
*Physical review / D*, 100(11):114516, and PUBDB-2020-00312, arXiv:1909.02521; ADP-19-19/T1099; DESY 19-149; DESY-19-149; Liverpool LTH 1211.  
doi: 10.1103/PhysRevD.100.114516.
- F. Bishara and C. B. Verhaaren.  
**Singleton portals to the twin sector.**  
*Journal of high energy physics*, 1905(05):016, and PUBDB-2019-02284, DESY-18-187; arXiv:1811.05977.  
doi: 10.1007/JHEP05(2019)016.
- J. de Blas et al.  
**On the future of Higgs, electroweak and diboson measurements at lepton colliders.**  
*Journal of high energy physics*, 2019(12):117, and PUBDB-2019-05665, arXiv:1907.04311; DESY-19-077; MITP/19-028.  
doi: 10.1007/JHEP12(2019)117.
- J. Blümlein, A. M. Maier and P. Marquard.  
**Five-Loop Static Contribution to the Gravitational Interaction Potential of Two Point Masses.**  
*Physics letters / B*, 800:135100, and PUBDB-2019-04474, DESY 19-029, DO-TH 19/01.  
doi: 10.1016/j.physletb.2019.135100.

- J. Blümlein, C. Raab and K. Schönwald.  
**The polarized two-loop massive pure singlet Wilson coefficient for deep-inelastic scatterin.**  
*Nuclear physics / B*, 948:23, and PUBDB-2019-03928, DESY 19-060, DO-TH 19/04, arXiv:1904.08911.  
doi: 10.1016/j.nuclphysb.2019.114736.
- J. Blümlein, P. Marquard and N. Rana.  
**Asymptotic behavior of the heavy quark form factors at higher order.**  
*Physical review / D*, 99(1):016013, and PUBDB-2019-00934.  
doi: 10.1103/PhysRevD.99.016013.
- J. Blümlein et al.  
**The  $O(\alpha^2)$  Initial State QED Corrections to  $e^+e^-$  Annihilation to a Neutral Vector Boson Revisited.**  
*Physics letters / B*, 791:206, and PUBDB-2019-01537, arXiv:1901.08018; DESY-18-226; DO-TH-18-30.  
doi: 10.1016/j.physletb.2019.02.038.
- J. Blümlein et al.  
**The unpolarized two-loop massive pure singlet Wilson coefficients for deep-inelastic scattering.**  
*Nuclear physics*, 945:114659, and PUBDB-2019-02484.  
doi: 10.1016/j.nuclphysb.2019.114659.
- J. Blümlein et al.  
**The effects of  $O(\alpha^2)$  initial state QED corrections to  $e^+e^- \rightarrow \gamma^*/Z^*$  at very high luminosity colliders.**  
*Physics letters / B*, 801:135196, and PUBDB-2020-00122, DESY 19-162, DO-TH 19/18, SAGEX-19-22.  
doi: 10.1016/j.physletb.2019.135196.
- J. Blümlein et al.  
**The heavy fermion contributions to the massive three loop form factors.**  
*Nuclear physics / B*, 949:114751, and PUBDB-2019-04197, arXiv:1908.00357, DESY 19-095, DO-TH 19/08, SAGEX-19-10, TIF-UNIMI-2019-13.  
doi: 10.1016/j.nuclphysb.2019.114751.
- A. Bourget, A. Pini and D. Rodríguez-Gómez.  
**Gauge theories from principally extended disconnected gauge groups.**  
*Nuclear physics*, 940:351, and PUBDB-2019-01974, DESY-18-046; arXiv:1804.01108.  
doi: 10.1016/j.nuclphysb.2019.02.004.
- A. Boveia et al.  
**Recommendations on presenting LHC searches for missing transverse energy signals using simplified  $s$ -channel models of dark matter.**  
*Physics of the Dark Universe*, 27:100365, and PUBDB-2020-00469, CERN-LPCC-2016-001; arXiv:1603.04156; FERMILAB-FN-1009-CD.  
doi: 10.1016/j.dark.2019.100365.
- S. Brass, W. Kilian and J. Reuter.  
**Parallel adaptive Monte Carlo integration with the event generator WHIZARD.**  
*The European physical journal / C*, 79(4):344, and PUBDB-2019-02287, arXiv:1811.09711; DESY-18-089; SI-HEP-2018-32.  
doi: 10.1140/epjc/s10052-019-6840-2.
- T. Bringmann et al.  
**Towards closing the window of primordial black holes as dark matter: The case of large clusterin.**  
*Physical review / D*, 99(6):063532, and PUBDB-2019-01978, DESY-18-132; arXiv:1808.05910.  
doi: 10.1103/PhysRevD.99.063532.
- F. Bruckmann, K. Jansen and S. Kühn.  
 **$O(3)$  nonlinear sigma model in 1 + 1 dimensions with matrix product states.**  
*Physical review / D*, 99(7):074501, and PUBDB-2019-01956, arXiv:1812.00944; DESY-18-213.  
doi: 10.1103/PhysRevD.99.074501.
- F. Buccella, A. Paul and P. Santorelli.  
**On  $SU(3)_F$  Breaking through Final State Interactions and CP Asymmetries in  $D \rightarrow PP$  Decays.**  
*Physical review / D*, 99(11):113001, and PUBDB-2019-02506, arXiv:1902.05564; DESY-19-025.  
doi: 10.1103/PhysRevD.99.113001.
- W. Buchmuller, M. Dierigl and Y. Tatsuta.  
**Magnetized orbifolds and localized flux.**  
*Annals of physics*, 401:91, and PUBDB-2019-00958, DESY-18-167.  
doi: 10.1016/j.aop.2018.12.006.
- W. Buchmuller, E. Dudas and Y. Tatsuta.  
**Quantum corrections for D-brane models with broken supersymmetry.**  
*Journal of high energy physics*, 2019(12):22, and PUBDB-2020-00464, arXiv:1909.03007; DESY 19-125; CPHT-RR046.072019; DESY-19-125.  
doi: 10.1007/JHEP12(2019)022.
- W. Buchmuller and K. M. Patel.  
**Proton decay in flux compactifications.**  
*Journal of high energy physics*, 1905(05):196, and PUBDB-2019-02912, DESY-19-049; arXiv:1904.08810.  
doi: 10.1007/JHEP05(2019)196.
- S. Caron-Huot et al.  
**Six-Gluon Amplitudes in Planar  $\mathcal{N} = 4$  Super-Yang-Mills Theory at Six and Seven Loops.**  
*Journal of high energy physics*, 1908(08):016, and PUBDB-2019-03246, arXiv:1903.10890; DESY-19-042; HU-EP-19/04; SLAC-PUB-17413.  
doi: 10.1007/JHEP08(2019)016.
- S. Caron-Huot et al.  
**The Cosmic Galois Group and Extended Steinmann Relations for Planar  $\mathcal{N} = 4$  SYM Amplitudes.**  
*Journal of high energy physics*, 2019(9):61, and PUBDB-2019-03749, arXiv:1906.07116; DESY-19-062; HU-EP-19-05; SLAC-PUB-17414.  
doi: 10.1007/JHEP09(2019)061.
- F. Carta, J. Moritz and A. Westphal.  
**Gaugino condensation and small uplifts in KKLT.**  
*Journal of high energy physics*, 2019(8):141, and PUBDB-2019-03747, DESY-19-012.  
doi: 10.1007/JHEP08(2019)141.



- M. Caselle et al.  
**Conformal field theory and the hot phase of three-dimensional U(1) gauge theory.**  
*Journal of high energy physics*, 1905(05):068, and PUBDB-2019-03375, arXiv:1903.00491; DESY-19-027.  
doi: 10.1007/JHEP05(2019)068.
- M. Caselle et al.  
**Conformal perturbation theory confronts lattice results in the vicinity of a critical point.**  
*Physical review / D*, 100(3):034512, and PUBDB-2019-03032, arXiv:1904.12749; DESY-19-073.  
doi: 10.1103/PhysRevD.100.034512.
- X. Chu, C. Garcia-Cely and H. Murayama.  
**Velocity Dependence from Resonant Self-Interacting Dark Matter.**  
*Physical review letters*, 122(7):071103, and PUBDB-2019-01981, arXiv:1810.04709; DESY-18-176.  
doi: 10.1103/PhysRevLett.122.071103.
- M. Cirelli et al.  
**Homeopathic Dark Matter, or how diluted heavy substances produce high energy cosmic rays.**  
*Journal of cosmology and astroparticle physics*, 2019(02):014, and PUBDB-2019-03958.  
doi: 10.1088/1475-7516/2019/02/014.
- M. Ciuchini et al.  
**New Physics in  $b \rightarrow s\ell^+\ell^-$  confronts new data on Lepton Universality.**  
*The European physical journal / C*, 79(8):719, and PUBDB-2019-03247, arXiv:1903.09632; DESY-19-043; CERN-TH-2019-033; UCI-TR-2019-07.  
doi: 10.1140/epjc/s10052-019-7210-9.
- I. Coman-Lohi, E. Pomoni and J. Teschner.  
**Toda Conformal Blocks, Quantum Groups, and Flat Connections.**  
*Communications in mathematical physics*, -, and PUBDB-2020-00238.  
doi: 10.1007/s00220-019-03617-y.
- Y. Cui et al.  
**Probing the pre-BBN universe with gravitational waves from cosmic strings.**  
*Journal of high energy physics*, 1901(1):81, and PUBDB-2020-00454, arXiv:1808.08968; KCL-PH-TH/2018-47.  
doi: 10.1007/JHEP01(2019)081.
- L. Da Rold and A. N. Rossia.  
**The minimal simple composite Higgs model.**  
*Journal of high energy physics*, 2019(12):23, and PUBDB-2019-05056, DESY-19-005.  
doi: 10.1007/JHEP12(2019)023.
- J. Davies et al.  
**Top quark mass dependence of the Higgs boson-gluon form factor at three loops.**  
*Physical review / D*, 100(3):034017, and PUBDB-2019-03963, arXiv:1906.00982, DESY 19-092, HU-EP-19/13, P3H-19-012, TTP19-014.  
doi: 10.1103/PhysRevD.100.034017.
- V. Del Duca et al.  
**Amplitudes in the Multi-Regge Limit of  $\mathcal{N} = 4$  SYM.**  
*Acta physica Polonica / B*, 12(4):961, and PUBDB-2019-04341, DESY-18-190.  
doi: 10.5506/APhysPolBSupp.12.961.
- F. Depta et al.  
**BBN constraints on the annihilation of MeV-scale dark matter.**  
*Journal of cosmology and astroparticle physics*, 1904(04):029, and PUBDB-2019-02288, arXiv:1901.06944; DESY-19-006.  
doi: 10.1088/1475-7516/2019/04/029.
- D. Dercks and T. Robens.  
**Constraining the Inert Doublet Model using Vector Boson Fusion.**  
*The European physical journal / C*, 79(11):924, and PUBDB-2020-00303, arXiv:1812.07913; DESY-18-222.  
doi: 10.1140/epjc/s10052-019-7436-6.
- D. Dercks et al.  
**Long-lived fermions at AL3X.**  
*Physical review / D*, 99(5):055020, and PUBDB-2019-01987, DESY-18-197; BONN-TH-2018-14; IFIC-18-39; arXiv:1811.01995.  
doi: 10.1103/PhysRevD.99.055020.
- L. Di Luzio, R. Gröber and G. Panico.  
**Probing new electroweak states via precision measurements at the LHC and future colliders.**  
*Journal of high energy physics*, 1901(01):011, and PUBDB-2019-00480, arXiv:1810.10993; DESY-18-184; HU-EP-18/30.  
doi: 10.1007/JHEP01(2019)011.
- M. Dias et al.  
**Pole N-flation.**  
*Journal of high energy physics*, 1902(02):120, and PUBDB-2019-01976, DESY-18-063; arXiv:1805.02659.  
doi: 10.1007/JHEP02(2019)120.
- M. Diehl, P. Plößl and A. Schäfer.  
**Proof of sum rules for double parton distributions in QCD.**  
*The European physical journal / C*, 79(3):253, and PUBDB-2019-01986, DESY-18-195; arXiv:1811.00289.  
doi: 10.1140/epjc/s10052-019-6777-5.
- M. Diehl and R. Nagar.  
**Factorisation of soft gluons in multiparton scattering.**  
*Journal of high energy physics*, 1904(04):124, and PUBDB-2019-02281, arXiv:1812.09509; DESY-18-204.  
doi: 10.1007/JHEP04(2019)124.
- M. Diehl et al.  
**Two-loop splitting in double parton distributions.**  
*SciPost physics*, 7(2):017, and PUBDB-2019-03245, arXiv:1902.08019; DESY-19-024; CERN-TH-2019-013.  
doi: 10.21468/SciPostPhys.7.2.017.
- P. Diessner and G. Weiglein.  
**Precise prediction for the W boson mass in the MRSSM.**  
*Journal of high energy physics*, 1907(07):011, and PUBDB-2019-02910, arXiv:1904.03634; DESY-19-035.  
doi: 10.1007/JHEP07(2019)011.

- P. Diessner et al.  
**Confronting the Coloured Sector of the MRSSM with LHC Data.**  
*Acta physica Polonica / B*, 50(11):1929, and PUBDB-2020-00319.  
doi: 10.5506/APhysPolB.50.1929.
- P. Diessner et al.  
**Confronting the coloured sector of the MRSSM with LHC data.**  
*Journal of high energy physics*, 1909(9):120, and PUBDB-2020-00218, arXiv:1907.11641.  
doi: 10.1007/JHEP09(2019)120.
- V. Domcke and S. Sandner.  
**The Different Regimes of Axion Gauge Field Inflation.**  
*Journal of cosmology and astroparticle physics*, 2019(09):038, and PUBDB-2019-03759, arXiv:1905.11372; DESY-19-089.  
doi: 10.1088/1475-7516/2019/09/038.
- V. Domcke et al.  
**Baryogenesis from axion inflation.**  
*Journal of cosmology and astroparticle physics*, 2019(10):032, and PUBDB-2019-03757, arXiv:1905.13318; DESY-19-084.  
doi: 10.1088/1475-7516/2019/10/032.
- V. Domcke et al.  
**Chiral anomaly and Schwinger effect in non-abelian gauge theories.**  
*Journal of high energy physics*, 1903(03):111, and PUBDB-2019-01991, arXiv:1812.08021; DESY-18-223; KEK-TH-2090.  
doi: 10.1007/JHEP03(2019)111.
- V. Domcke et al.  
**Emerging chromo-natural inflation.**  
*Journal of cosmology and astroparticle physics*, 1904(04):034, and PUBDB-2019-02286, DESY-18-106; arXiv:1807.03358.  
doi: 10.1088/1475-7516/2019/04/034.
- J. Drummond et al.  
**Cluster adjacency and the four-loop NMHV heptagon.**  
*Journal of high energy physics*, 1903(03):087, and PUBDB-2019-01988, DESY-18-214; arXiv:1812.04640.  
doi: 10.1007/JHEP03(2019)087.
- I. Dubovyk et al.  
**Electroweak pseudo-observables and Z-boson form factors at two-loop accuracy.**  
*Journal of high energy physics*, 2019(8):113, and PUBDB-2019-04045.  
doi: 10.1007/JHEP08(2019)113.
- M. A. Ebert et al.  
**Subleading Power Rapidity Divergences and Power Corrections for  $q_T$ .**  
*Journal of high energy physics*, 1904(04):123, and PUBDB-2019-02279, arXiv:1812.08189; DESY-18-207; MIT-CTP 5087.  
doi: 10.1007/JHEP04(2019)123.
- J. Eby et al.  
**Classical nonrelativistic effective field theory and the role of gravitational interactions.**  
*Physical review / D*, 99(12):123503, and PUBDB-2019-02499, DESY-18-124; arXiv:1807.09795.  
doi: 10.1103/PhysRevD.99.123503.
- Y. Ema.  
**Dynamical emergence of scalaron in Higgs inflation.**  
*Journal of cosmology and astroparticle physics*, 2019(09):027, and PUBDB-2019-03763, arXiv:1907.00993; DESY-19-117.  
doi: 10.1088/1475-7516/2019/09/027.
- Y. Ema, K. Nakayama and Y. Tang.  
**Production of purely gravitational dark matter: the case of fermion and vector boson.**  
*Journal of high energy physics*, 1907(07):060, and PUBDB-2019-02904, arXiv:1903.10973; DESY-19-050; KEK-TH-2114; UT-19-04.  
doi: 10.1007/JHEP07(2019)060.
- Y. Ema, F. Sala and R. Sato.  
**Light Dark Matter at Neutrino Experiments.**  
*Physical review letters*, 122(18):181802, and PUBDB-2019-02282, DESY-18-194; arXiv:1811.00520.  
doi: 10.1103/PhysRevLett.122.181802.
- I. Engeln, M. Mühlleitner and J. Wittbrodt.  
**N2HDECAY: Higgs boson decays in the different phases of the N2HDM.**  
*Computer physics communications*, 234:256, and PUBDB-2018-03905, DESY-18-064; KA-TP-09-2018; arXiv:1805.00966.  
doi: 10.1016/j.cpc.2018.07.020.
- FCC Collaboration.  
**HE-LHC: The High-Energy Large Hadron Collider.**  
*European physical journal special topics*, 228(5):1109, and PUBDB-2019-02864, CERN-ACC-2018-0059.  
doi: 10.1140/epjst/e2019-900088-6.
- FCC collaboration.  
**FCC-hh: The Hadron Collider.**  
*European physical journal special topics*, 228(4):755, and PUBDB-2019-02712.  
doi: 10.1140/epjst/e2019-900087-0.
- U. Feindt et al.  
**simsurvey : estimating transient discovery rates for the Zwicky transient facility.**  
*Journal of cosmology and astroparticle physics*, 2019(10):005, and PUBDB-2019-03879.  
doi: 10.1088/1475-7516/2019/10/005.
- P. M. Ferreira et al.  
**Vacuum instabilities in the N2HDM.**  
*Journal of high energy physics*, 2019(9):6, and PUBDB-2019-03758, arXiv:1905.10234; DESY-19-085; KA-TP-07-2019.  
doi: 10.1007/JHEP09(2019)006.

- N. Fonseca de Sa et al.  
**Super-Planckian axions from near-conformality.**  
*Physical review / D*, 100(10):105019, and PUBDB-2019-05059, DESY-19-063.  
doi: 10.1103/PhysRevD.100.105019.
- N. Fonseca and E. Morgante.  
**Relaxion Dark Matter.**  
*Physical review / D*, 100(5):055010, and PUBDB-2020-00279, arXiv:1809.04534; DESY 18-161; DESY-18-161.  
doi: 10.1103/PhysRevD.100.055010.
- A. Francis et al.  
**Lattice QCD study of the H dibaryon using hexaquark and two-baryon interpolators.**  
*Physical review / D*, 99(7):074505, and PUBDB-2019-02384, CERN-TH-2018-098; DESY-18-066; HIM-2018-02; MITP-18-030; TIFR-TH-18-12; arXiv:1805.03966.  
doi: 10.1103/PhysRevD.99.074505.
- Fπ, Jefferson Lab.  
**Unique Access to  $u$ -Channel Physics: Exclusive Backward-Angle Omega Meson Electroproduction.**  
*Physical review letters*, 123(18):182501, and PUBDB-2020-00497, arXiv:1910.00464; JLAB-PHY-19-3091.  
doi: 10.1103/PhysRevLett.123.182501.
- A. Gainutdinov and I. Runkel.  
**The non-semisimple Verlinde formula and pseudo-trace functions.**  
*Journal of pure and applied algebra*, 223(2):660, and PUBDB-2020-00475, arXiv:1605.04448; ZMP-HH-16-8; HAMBURGER-BEITRAGE-ZUR-MATHEMATIK-593; ZMP-HH/16-8; Hamburger Beitrage zur Mathematik 593.  
doi: 10.1016/j.jpaa.2018.04.014.
- M. F. Garcia Vera and R. Sommer.  
**Large  $N$  scaling and factorization in  $SU(N)$  Yang-Mills gauge theory.**  
*The European physical journal / C*, 79(1):35, and PUBDB-2019-01169, DESY-18-075; arXiv:1805.11070.  
doi: 10.1140/epjc/s10052-019-6539-4.
- A. E. D. Gerardin, H. B. Meyer and A. Nyffeler.  
**Lattice calculation of the pion transition form factor with  $N_f = 2 + 1$  Wilson quarks.**  
*Physical review / D*, 100(3):034520, and PUBDB-2019-05350.  
doi: 10.1103/PhysRevD.100.034520.
- A. Gérardin, T. Harris and H. B. Meyer.  
**Nonperturbative renormalization and  $O(a)$ -improvement of the nonsinglet vector current with  $N_f = 2 + 1$  Wilson fermions and tree-level Symanzik improved gauge action.**  
*Physical review / D*, 99(1):014519, and PUBDB-2019-01028.  
doi: 10.1103/PhysRevD.99.014519.
- A. Gérardin et al.  
**Leading hadronic contribution to  $(g - 2)_\mu$  from lattice QCD with  $N_f = 2 + 1$  flavors of  $O(a)$  improved Wilson quarks.**  
*Physical review / D*, 100(1):014510, and PUBDB-2020-00034.  
doi: 10.1103/PhysRevD.100.014510.
- F. Giese and T. Konstandin.  
**Vacuum stability of Froggatt-Nielsen models.**  
*Journal of high energy physics*, 2019(12):91, and PUBDB-2019-05667, DESY-19-158.  
doi: 10.1007/JHEP12(2019)091.
- L. Giusti et al.  
**Frequency-splitting estimators of single-propagator traces.**  
*The European physical journal / C*, 79(7):586, and PUBDB-2019-02914, arXiv:1903.10447; DESY-19-046.  
doi: 10.1140/epjc/s10052-019-7049-0.
- J. R. Green et al.  
**Excited-state effects in nucleon structure on the lattice using hybrid interpolators.**  
*Physical review / D*, 100(7):9, and PUBDB-2019-04199, arXiv:1907.11950, DESY 19-132.  
doi: 10.1103/PhysRevD.100.074510.
- R. Gröber, A. Maier and T. Rauh.  
**Top quark mass effects in  $g g \rightarrow Z Z$  at two loops and off-shell Higgs boson interference.**  
*Physical review / D*, 100(11):114013, and PUBDB-2019-05377, arXiv:1908.04061; DESY-19-136; HU-EP-19/23; SAGEX-19-18.  
doi: 10.1103/PhysRevD.100.114013.
- C. Grojean, M. Montull Garcia and M. Riemann.  
**Diboson at the LHC vs LEP.**  
*Journal of high energy physics*, 2019(3):20, and PUBDB-2019-04339, DESY 17-231.  
doi: 10.1007/JHEP03(2019)020.
- Group, LHC Dark Matter Working.  
**LHC Dark Matter Working Group: Next-generation spin-0 dark matter models.**  
*Physics of the Dark Universe*, 27:100351, and PUBDB-2020-00468, arXiv:1810.09420; CERN-LPCC-2018-02.  
doi: 10.1016/j.dark.2019.100351.
- K. Harigaya, K. Mukaida and M. Yamada.  
**Dark matter production during the thermalization era.**  
*Journal of high energy physics*, 1907(07):059, and PUBDB-2019-02908, arXiv:1901.11027; DESY-19-014.  
doi: 10.1007/JHEP07(2019)059.
- A. Hartin, A. Ringwald and N. Tapia.  
**Measuring the boiling point of the vacuum of quantum electrodynamics.**  
*Physical review / D*, 99(3):036008, and PUBDB-2019-01195, DESY 18-128.  
doi: 10.1103/PhysRevD.99.036008.
- T. Hartung and K. Jansen.  
**Zeta-regularized vacuum expectation values.**  
*Journal of mathematical physics*, 60(9):093504, and PUBDB-2019-03777.  
doi: 10.1063/1.5085866.
- N. Hasan et al.  
**Nucleon axial, scalar, and tensor charges using lattice QCD at the physical pion mass.**  
*Physical review / D*, 99(11):114505, and PUBDB-2020-00412, arXiv:1903.06487; DESY-19-044; DESY 19-044.  
doi: 10.1103/PhysRevD.99.114505.



- A. Hebecker et al.  
**Thraxions: ultralight throat axions.**  
*Journal of high energy physics*, 1904(04):158, and PUBDB-2019-02280, arXiv:1812.03999; DESY-18-212.  
doi: 10.1007/JHEP04(2019)158.
- W. G. Hollik et al.  
**Phenomenology of the inflation-inspired NMSSM at the electroweak scale.**  
*The European physical journal / C*, 79(1):75, and PUBDB-2019-05664, DESY-17-075.  
doi: 10.1140/epjc/s10052-019-6561-6.
- W. Hollik, G. Weiglein and J. Wittbrodt.  
**Impact of vacuum stability constraints on the phenomenology of supersymmetric models.**  
*Journal of high energy physics*, 1903(03):109, and PUBDB-2019-01979, arXiv:1812.04644; DESY-18-148; TTP 18-036.  
doi: 10.1007/JHEP03(2019)109.
- R. Horsley et al.  
**Isospin splittings in the decuplet baryon spectrum from dynamical QCD+QED.**  
*Journal of physics / G*, 46(11):115004, and PUBDB-2019-03249.  
doi: 10.1088/1361-6471/ab32c1.
- IAXO Collaboration.  
**Physics potential of the International Axion Observatory (IAXO).**  
*Journal of cosmology and astroparticle physics*, 1906(06):047, and PUBDB-2019-02656, arXiv:1904.09155.  
doi: 10.1088/1475-7516/2019/06/047.
- B. Ihrig et al.  
**Abelian Higgs model at four loops, fixed-point collision, and deconfined criticality.**  
*Physical review / B*, 100(13):134507, and PUBDB-2019-03962, arXiv:1907.08140, HU-EP-19/19, DESY 19-124, SAGEX-19-16.  
doi: 10.1103/PhysRevB.100.134507.
- S. Imai and Y. Tatsuta.  
**Wavefunctions on  $S^2$  with flux and branes.**  
*Journal of high energy physics*, 1907(07):005, and PUBDB-2019-02909, arXiv:1902.04307; WU-HEP-19-03; DESY-19-018.  
doi: 10.1007/JHEP07(2019)005.
- F. Jegerlehner.  
**The Hierarchy Problem and the Cosmological Constant Problem Revisited.**  
*Foundations of physics*, 49(9):915, and PUBDB-2019-03959, arXiv:1812.03863; DESY-18-211.  
doi: 10.1007/s10701-019-00262-2.
- R. Jinno, T. Konstandin and M. Takimoto.  
**Relativistic bubble collisions—a closer look.**  
*Journal of cosmology and astroparticle physics*, 2019(09):035, and PUBDB-2019-03760, arXiv:1906.02588; DESY-19-102.  
doi: 10.1088/1475-7516/2019/09/035.
- R. Jinno et al.  
**Gravitational waves from first-order phase transitions: ultra-supercooled transitions and the fate of relativistic shocks.**  
*Journal of cosmology and astroparticle physics*, 2019(10):033, and PUBDB-2019-03752, arXiv:1905.00899; DESY-19-067; CTPU-PTC-19-12; KEK-TH-2125.  
doi: 10.1088/1475-7516/2019/10/033.
- S. Knirck et al.  
**A first look on 3D effects in open axion haloscopes.**  
*Journal of cosmology and astroparticle physics*, 1908(08):026, and PUBDB-2019-03229, DESY-19-075; MPP-2019-89; NORDITA-2019-049; arXiv:1906.02677.  
doi: 10.1088/1475-7516/2019/08/026.
- T. Konstandin, R. A. Porto and H. Rubira.  
**The effective field theory of large scale structure at three loops.**  
*Journal of cosmology and astroparticle physics*, 2019(11):027, and PUBDB-2019-05061, arXiv:1906.00997; DESY-19-094.  
doi: 10.1088/1475-7516/2019/11/027.
- J. Kummer et al.  
**Simulations of core formation for frequent dark matter self-interactions.**  
*Monthly notices of the Royal Astronomical Society*, 487(1):354, and PUBDB-2019-02505, arXiv:1902.02330; DESY-19-020; TTK-19-06.  
doi: 10.1093/mnras/stz1261.
- P. Longhi, F. Nieri and A. Pittelli.  
**Localization of 4d  $\mathcal{N} = 1$  theories on  $\mathbb{D}^2 \times \mathbb{T}^2$ .**  
*Journal of high energy physics*, 1912:147, and PUBDB-2020-00222, arXiv:1906.02051.  
doi: 10.1007/JHEP12(2019)147.
- G. Lusterians et al.  
**Joint Two-Dimensional Resummation in  $q_T$  and 0-Jettiness at NNLL.**  
*Journal of high energy physics*, 1903(03):124, and PUBDB-2019-01993, arXiv:1901.03331; DESY-19-004; NIKHEF-2018-053.  
doi: 10.1007/JHEP03(2019)124.
- MADMAX Collaboration.  
**A new experimental approach to probe QCD axion dark matter in the mass range above 40  $\mu\text{eV}$ .**  
*The European physical journal / C*, 79(3):186, and PUBDB-2019-01463, DESY-19-011; arXiv:1901.07401.  
doi: 10.1140/epjc/s10052-019-6683-x.
- I. de Medeiros Varzielas and J. Talbert.  
**Simplified models of flavourful leptiquarks.**  
*The European physical journal / C*, 79(6):536, and PUBDB-2019-02907, DESY-18-210; arXiv:1901.10484.  
doi: 10.1140/epjc/s10052-019-7047-2.
- D. Meuser and A. Voigt.  
**Investigating multiple solutions to boundary value problems in constrained minimal and non-minimal SUSY models.**  
*The European physical journal / C*, 79(10):821, and PUBDB-2019-03764, arXiv:1907.07686; DESY-19-129; TTK-19-28.  
doi: 10.1140/epjc/s10052-019-7352-9.

J. K. L. Michel, P. Pietrulewicz and F. J. Tackmann.  
**Jet veto resummation with jet rapidity cuts.**  
*Journal of high energy physics*, 1904(04):142, and PUBDB-2019-02283, arXiv:1810.12911; DESY-18-189.  
 doi: 10.1007/JHEP04(2019)142.

J. Moritz, A. Retolaza and A. Westphal.  
**On uplifts by warped anti-D3-branes.**  
*Fortschritte der Physik*, 67(1-2):1800098, and PUBDB-2019-01980, arXiv:1809.06618; DESY-18-165.  
 doi: 10.1002/prop.201800098.

Z. Nagy and D. E. Soper.  
**Effect of color on rapidity gap survival.**  
*Physical review / D*, 100(7):074012, and PUBDB-2019-03756, arXiv:1905.07176; DESY-19-082.  
 doi: 10.1103/PhysRevD.100.074012.

Z. Nagy and D. E. Soper.  
**Exponentiating virtual imaginary contributions in a parton shower.**  
*Physical review / D*, 100(7):074005, and PUBDB-2019-03766, arXiv:1908.11420; DESY-19-143.  
 doi: 10.1103/PhysRevD.100.074005.

Z. Nagy and D. E. Soper.  
**Parton showers with more exact color evolution.**  
*Physical review / D*, 99(5):054009, and PUBDB-2019-01995, arXiv:1902.02105; DESY-19-013.  
 doi: 10.1103/PhysRevD.99.054009.

G. Panico, A. Pomarol and M. Riemann.  
**EFT approach to the electron electric dipole moment at the two-loop level.**  
*Journal of high energy physics*, 1904(04):090, and PUBDB-2019-01984, arXiv:1810.09413; DESY-18-185.  
 doi: 10.1007/JHEP04(2019)090.

K. H. Phan and T. Riemann.  
**Scalar 1-loop Feynman integrals as meromorphic functions in space-time dimension d.**  
*Physics letters / B*, 791:257, and PUBDB-2019-01570, DESY-19-034; HCMUS-19-01; KW-18-004; arXiv:1812.10975.  
 doi: 10.1016/j.physletb.2019.02.044.

X. C. Vidal et al.  
**New axion searches at flavor factories.**  
*Journal of high energy physics*, 1901(01):113, and PUBDB-2019-00960, arXiv:1810.09452; DESY-18-183.  
 doi: 10.1007/JHEP01(2019)113.

N. Zerf et al.  
**Critical properties of the Néel–algebraic-spin-liquid transition.**  
*Physical review / B*, 100(23):235130, and PUBDB-2020-00030, DESY 19-065, DESY-19-065, HU-EP-19/09, LTH 1201, SAGEX-19-15, arXiv:1905.03719.  
 doi: 10.1103/PhysRevB.100.235130.

#### Master Thesis

S. M. Rodrigues Sandner.  
**Pseudo Nambu-Goldstone Boson Inflation.**  
 University of Hamburg, 2019.

#### Ph.D. Thesis

T. Bourton.  
**Exact Results for N=1 Theories of Class  $S_k$ .**  
 University of Hamburg, 2019.

S. Bruggisser.  
**Flavour cosmology: Electroweak baryogenesis from varying Yukawas.**  
 Universität Hamburg, Hamburg, 2019.

V. Chestnov.  
**High-precision computation of observables in supersymmetric Yang–Mills theory.**  
 Universität Hamburg, Hamburg, 2019.

J. Kummer.  
**Astrophysical Implications of Self-interacting Dark Matter.**  
 Universität Hamburg, Hamburg, 2019.

J. Moritz.  
**On accelerated expansion in string theory.**  
 Universität Hamburg, Hamburg, 2019.

R. Nagar.  
**Double parton scattering: effects of colour.**  
 Universität Hamburg, Hamburg, 2019.

K. Schönwald.  
**Massive two- and three-loop calculations in QED and QCD.**  
 TU Dortmund, Hamburg, 2019.

J. Wittbrodt.  
**Exploring Models of Electroweak Symmetry Breaking at the LHC and Beyond.**  
 Universität Hamburg, Hamburg, 2019.

#### ZEUS

##### Published

H. Abramowicz et al.  
**Limits on contact interactions and leptiquarks at HERA.**  
*Physical review / D*, D99(9):092006, and PUBDB-2019-02597, arXiv:1902.03048; DESY-19-022.  
 doi: 10.1103/PhysRevD.99.092006.

ZEUS Collaboration.  
**Charm production in charged current deep inelastic scattering at HERA.**  
*Journal of high energy physics*, 1905(05):201, and PUBDB-2019-02495, arXiv:1904.03261; DESY-19-054.  
 doi: 10.1007/JHEP05(2019)201.

### **Photographs and graphics**

Gesine Born, DESY  
Kara Budge  
L. Castillo Garcia, IFAE Barcelona  
F. Garcia Fuentes, U Helsinki  
Ingrid-Maria Gregor  
Sinje Hasheider, DESY  
Claudia Höhne, DESY  
H. Lacker, HU Berlin  
Giulia Marthaler, ETH  
Marta Mayer, DESY  
Martin Mug  
Margitta Müller, DESY  
Susann Niedworok, DESY

Dirk Nölle, DESY  
V. Schöttmer, UHH  
Nick Walker, DESY  
Christoph Wehrer, “Haus der kleinen  
Forscher” foundation

Belle II / KEK  
CERN  
DESY  
DESY Science Communication Lab  
IFIC  
IPhO / IPN  
University of Oxford

Spengler Wiescholek Architekten  
Stadtplaner, WES GmbH  
Landschaftsarchitekten,  
Urban Catalyst GmbH;  
Visualisation: Moka-studio;  
Aerial image: Matthias Friedel  
Office to the President of the  
Republic of Armenia

The figures were reproduced by  
permission of authors or journals.

### **Acknowledgement**

We would like to thank all authors and everyone who helped in the creation of this annual report. ●



## Imprint

### **Publishing and contact**

Deutsches Elektronen-Synchrotron DESY  
A Research Centre of the Helmholtz Association

Hamburg location:

Notkestr. 85, 22607 Hamburg, Germany  
Tel.: +49 40 8998-0, Fax: +49 40 8998-3282  
desyinfo@desy.de

Zeuthen location:

Platanenallee 6, 15738 Zeuthen, Germany  
Tel.: +49 33762 7-70, Fax: +49 33762 7-7413  
desyinfo.zeuthen@desy.de

[www.desy.de](http://www.desy.de)

ISBN 978-3-945931-28-8

doi 10.3204/PUBDB-2019-05176

### **Editing**

Ilka Flegel, Manfred Fleischer, Thomas Konstandin

### **Layout**

Sabine Kuhls-Dawideit, Büro für Grafik und Design, Halstenbek

### **Production**

Britta Liebaug

### **Printing**

ac europrint gmbh, Hamburg

### **Editorial deadline**

30 March 2020

### **Editorial note**

The authors of the individual scientific contributions published in this report are fully responsible for the contents.

Reproduction including extracts is permitted subject to crediting the source.  
This report is neither for sale nor may be resold.

**Deutsches Elektronen-Synchrotron DESY**  
**A Research Centre of the Helmholtz Association**

The Helmholtz Association is a community of 18 scientific-technical and biological-medical research centres. These centres have been commissioned with pursuing long-term research goals on behalf of the state and society. The Association strives to gain insights and knowledge so that it can help to preserve and improve the foundations of human life. It does this by identifying and working on the grand challenges faced by society, science and industry. Helmholtz Centres perform top-class research in strategic programmes in six core fields: Energy, Earth & Environment, Health, Aeronautics, Space and Transport, Matter, and Key Technologies.

[www.helmholtz.de](http://www.helmholtz.de)